

## Flush Mount Occupancy Motion Sensor



### HMW28/PRO

On/off control & Low-bay

# HYTRONIK®



### Product Description

HMW28/PRO is Microwave standalone motion sensor integrated with Hytronik True occupancy detection technology, On/Off control with one relay channel output, which is NO (normally open contact). The Hytronik True occupancy detection technology works to detect human breathing rather than the mirror movements. No matter if the person sit/stand statically or turns their back to the sensor. The sensor can accurately recognize occupancy and keeps the lights on all the time. It is ideal for typical indoor applications such as classroom, office, healthcare, and other commercial areas.



### Features

- Store settings in the remote for easy commissioning when programming multiple sensors
- Intelligent photodiode - lights and sensors only operate when needed, natural light has priority
- NO contact
- Zero crossing detection to reduce in-rush current and maximise relay life
- Max withstandable in-rush current: 120A@160µs
- Black & White & Gray metal surface mount box options
- User-friendly design for installation
- 5 Year warranty

### Technical Data

Input Characteristics	
Mains voltage	220~240VAC 50/60Hz
Stand-by power	<0.3W
Load ratings:	800VA (Capacitive) 800W (Resistive)
Max withstandable in-rush current	120A@160µs
Warming-up	20s

Safety and EMC	
EMC standard (EMC)	EN61547, EN55015, EN61000-3/2/-3/3
Safety standard (LVD)	EN60669-1, EN60669-2-1
RED	EN300400, EN301489-1/-3, EN50663
Certification	UKCA, CE, RCM

Sensor Data	
Sensor Model	Occupancy Motion detection
Detection range (Max.)*	Installation Height : 3m Detection Range(Ø) : 10m
Detection angle	360°

\* For more details of detection range, please refer to "detection pattern" section.

Environment	
Operation temperature	Ta: -20°C ~ +50°C
IP rating	IP20/IP54

## Mechanical Structure

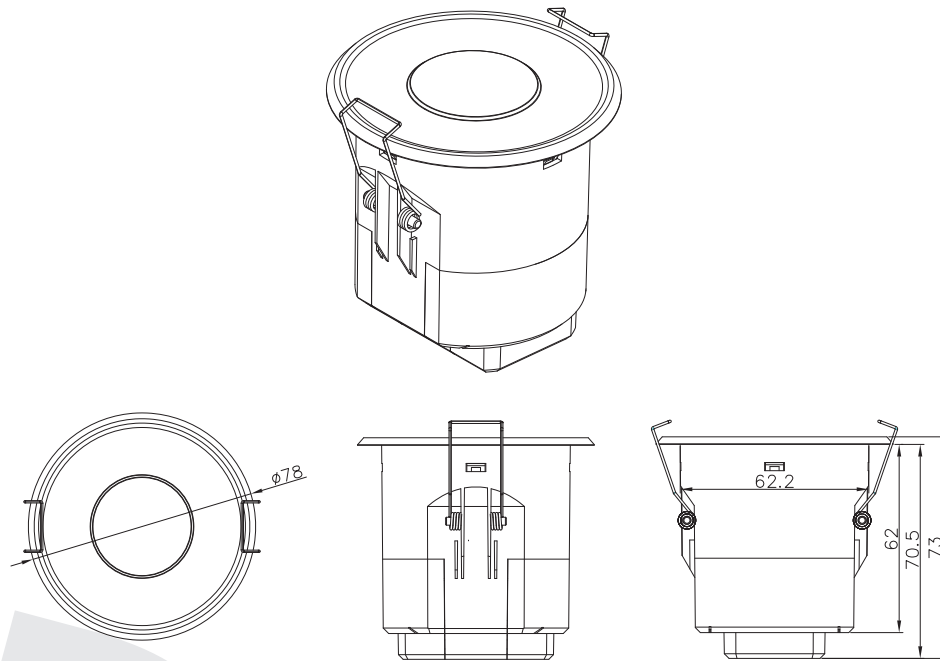

Note:

1. We recommend the mounting distance between sensors to exceed each sensor's maximum radius detection range individually, to mitigate the risk of false-triggering.
2. The face-to-face installation between sensors and sensors or other radio sources is not recommended, or false trigger issue will potentially behave.  
Make sure the installed environment is free of any obvious vibration, strong air blows, curtain swing, water flow in pipe .....

## Wiring Diagram

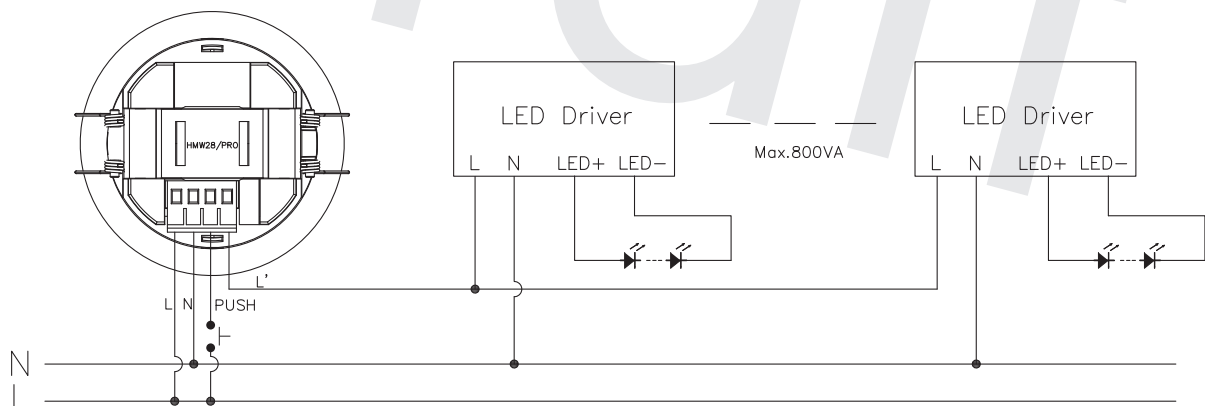

## Wire Preparation

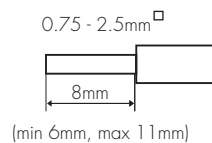
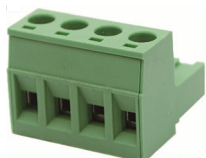

Pluggable screw terminal. It is recommended to make connections to the terminal before fitting to the sensor.

## Detection Pattern

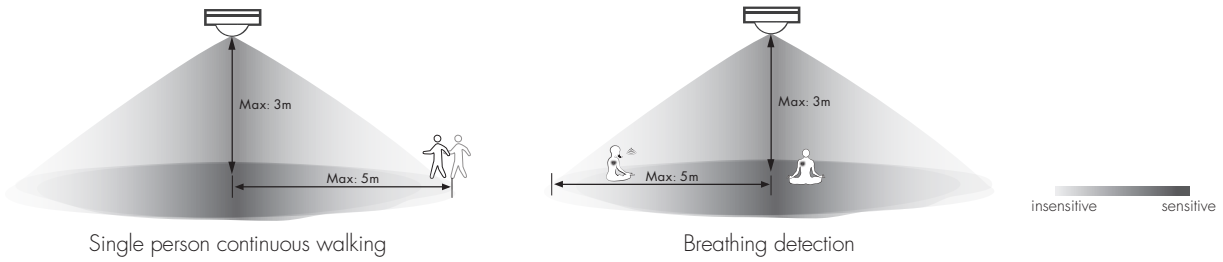

When it's in breathing & true occupancy detection mode and in sitting situation, facing to sensor directly will have a better detection range than 90 degrees side facing to sensor.

## Optional Accessory --- Ceiling/Surface Metal Mount Box: HA09/W, HA09/B, HA09/G

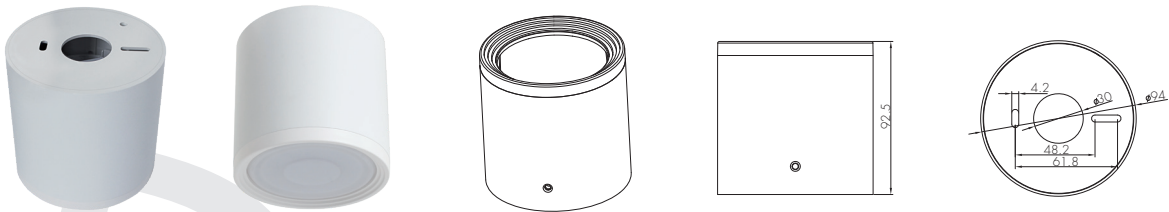

## Big and small silicon gasket used to make IP54 degree protection when mounted into HA09 housing for ceiling mount



## Optional Accessory --- HA08

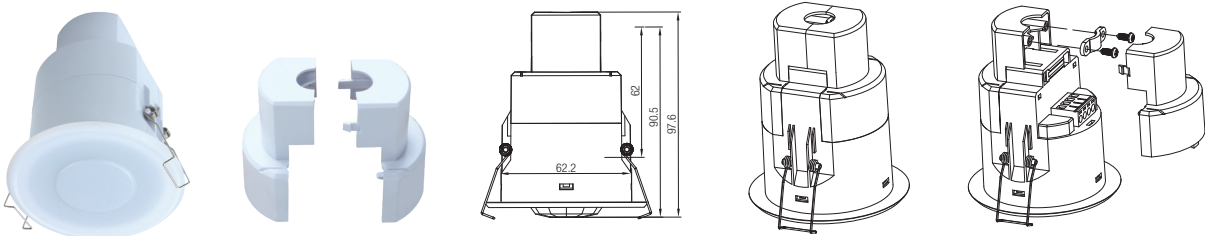

\*Note: Optional Accessory HA09 & HA08 can not be used together.

### 1 On/ off Control

This sensor is a motion switch, which turns on the light upon detection of motion or breathing, and turns off after a pre-selected hold-time when there is no movement or breathing. A daylight sensor is also built in to prevent the light from switching on when there is sufficient natural light.

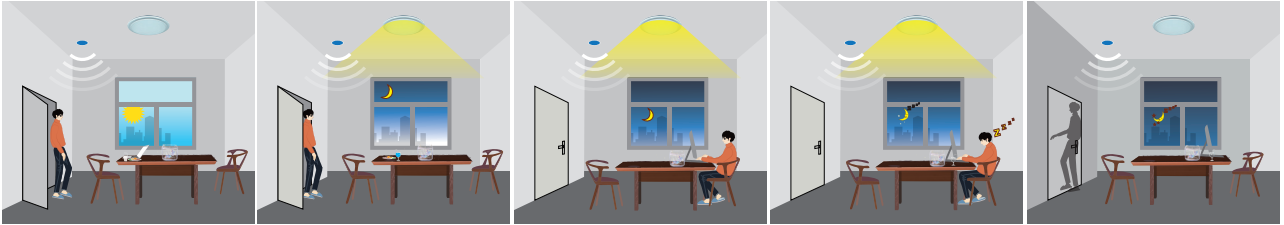

### 2 Lux Off Function

The built-in photodiode will also automatically turn off the light when the ambient natural light exceeds the programmed lux level for more than 5min, regardless of whether motion is detected or not.

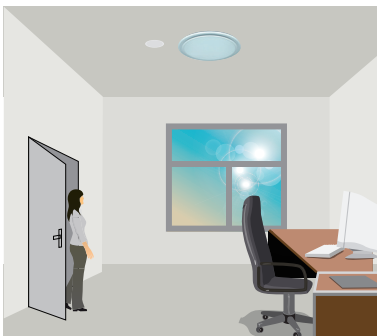

With sufficient natural light, the light does not switch on when occupancy is detected.

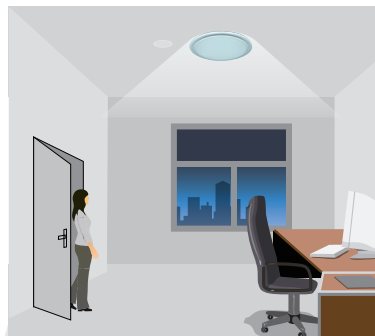

With insufficient natural light, the sensor switches on the light automatically when occupancy is detected.



The sensor switches off the light when natural light is sufficient, even with occupancy.

### 3 Manual Override

With the help of push-switch, this sensor can be over-riden by the end-user to manually switch on/off the light, which makes the product more user-friendly and offers more options to fit some extra-ordinary demands:

\* Short Push (< 1s): on/off function;

On → Off: the light turns off immediately and cannot be triggered ON by motion until the expiration of pre-set hold-time. After this period, the sensor goes back to normal sensor mode.

Off → On: the light turns on and goes to sensor mode, no matter if ambient Lux level exceeds the daylight threshold or not.

*Note: if end-user do not want this manual override function, just leave the "push" terminal unconnected to any wire.*

### 4 Semi-auto Mode (Absence Detection)

It is easy to forget to switch off the light, in office, corridor, even at home. And in many other cases, people do not want to have a sensor to switch on the light automatically, for example, when people just quickly pass-by, there is no need to have the light on. The solution is to apply this "absence detector": motion sensor is employed, but only activated on the manual press of the push-switch, the light keeps being ON in the occupancy, and switches off in the long absence.

*Note: end-user can choose either function 3 or function 4 for application. Default function is manual override.*

### 5 Zero-cross Relay Operation

Designed in the software, sensor switches on/off the load right at the zero-cross point, to ensure that the in-rush current is minimised, enabling the maximum lifetime of the relay.

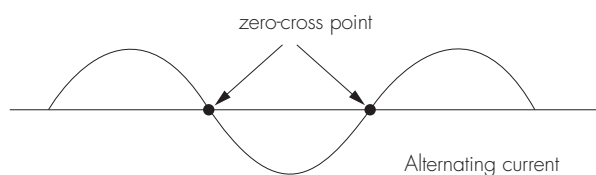

## Settings (Remote Control HRC-12)

ON / OFF

### Permanent ON/OFF function

Press button "ON/OFF" to select permanent ON or permanent OFF mode.

\* Press button "AUTO", "RESET" or "Ambient" to quit this mode.

The mode will change to AUTO Mode after power failure.

RESET

### Reset Settings

Press button "RESET", all settings go back to default values as below:

Detection range: 100%; Hold-time: 5min; Lux disabled

AUTO

### Sensor mode

Press "Auto Mode" button, the sensor starts to function and all settings remain the same as the latest status before the light is switched on/off.

SEMI  
AUTO

### SEMI-AUTO mode

Press "SEMI-AUTO" button, to enter semi-auto mode. The fixture is manually on by push-switch and automatically off in this mode.

### Detection range

Press buttons in zone "HF sensor Detection range" to set detection range at 100% / 75% / 50% / 10%.

### Daylight threshold

Press buttons in zone "Daylight threshold" to set daylight sensor at 2Lux/ 10Lux / 50Lux / 100Lux / 300Lux / 500Lux / Disable.

### Ambient daylight threshold

Press button "Ambient", the surrounding lux level is sampled and set as the new daylight threshold.

### Hold-time

Press buttons in zone "hold-time" to set the hold-time at 5sec / 1min / 5min / 10min / 15min / 30min / 60min.

Press button 30min / 60min, the actual setting is 25min.



HRC-12

## Additional Information / Documents

1. Regarding precautions for HF sensor installation and operation, please kindly refer to [www.hytronik.com/download ->knowledge ->Microwave Sensors - Precautions for Product Installation and Operation](http://www.hytronik.com/download->knowledge->Microwave+Sensors+-+Precautions+for+Product+Installation+and+Operation)
2. Regarding Hytronik standard guarantee policy, please refer to [www.hytronik.com/download ->knowledge ->Hytronik Standard Guarantee Policy](http://www.hytronik.com/download->knowledge->Hytronik+Standard+Guarantee+Policy)