

## On/off Control HF Sensor

HC009S-KD  
Detached Version

# HYTRONIK®

CE RED  CB IP20 UK CA

### Applications

Occupancy detector with on/off control suitable for indoor use.



Suitable for building into the fixture:

- Office / Commercial Lighting
- Meeting room
- Classroom

Use for new luminaire designs and installations



### Features

-  Zero crossing detection circuit reduces in-rush current and prolongs relay life
-  Loop-in and loop-out terminal for efficient installation
-  5-Year Warranty

### Technical Data

#### Input Characteristics

Model No.	HC009S-KD
Mains voltage	220~240VAC 50/60Hz
Stand-by power	<0.5W
Load ratings:	
Capacitive	400VA
Resistive	800W
Warming-up	20s

#### Safety and EMC

EMC standard (EMC)	EN55015, EN61000-3-2/-3-3, EN61547
Safety standard (LVD)	EN60669-2-1, EN60669-1
Radio Equipment (RED)	EN300440, EN301489-1/-3, EN50663
Certification	CB, CE, RED, RCM, UKCA

#### Sensor Data

Model No.	HC009S-KD
Sensor principle	High Frequency (microwave)
Operation frequency	5.8GHz +/- 75MHz
Transmission power	<0.2mW
Detection range	Max. (Ø x H) 12m x 6m
Detection angle	30° ~ 150°
Setting adjustments:	
Sensitivity	10% / 25% / 50% / 75% / 100%
Hold-time	10s ~ 30min (selectable)
Daylight threshold	5 ~ 50 lux, disabled

#### Environment

Operation temperature	Ta: -20°C ~ +60°C
Case temperature (Max.)	Tc: +80°C
IP rating	IP20

## Mechanical Structure

### A. Sensor Main body

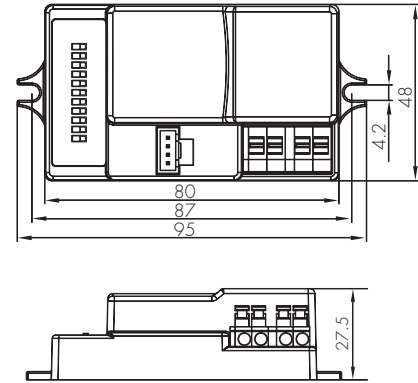
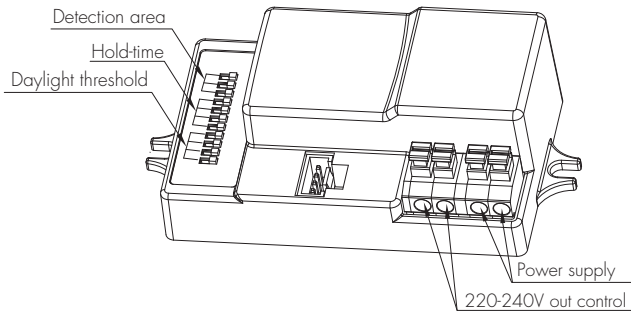

### B. Detached Sensor Antenna Module

#### Model SAM4

HF sensor head

Tri-level Dimming

The default cable length is around 30cm.

(Other cable length can be supplied upon request)

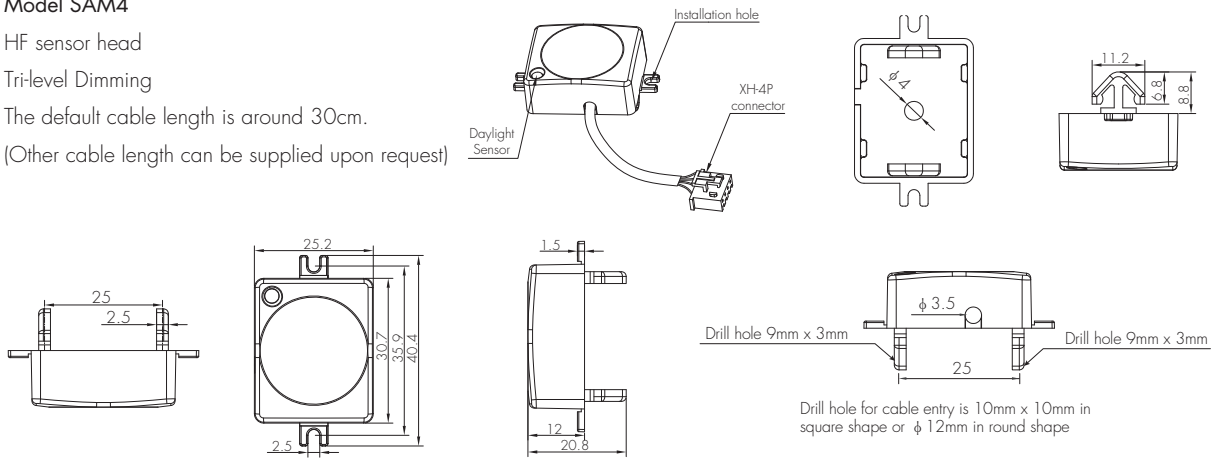

#### Note

1. It is recommended the mounting distance between sensor to sensor should be more than 2m to prevent sensors from false-triggering.
2. Should ensure the proper connection of the sensor main body (HCO09S/KD) and sensor head (SAM4), as the improper connection may lead the software to continuously detect the sensor head type when powered up. This can result in luminaires flashing to indicate a problem.
3. Verify that the daylight sensor is not covered or hidden within the luminaires. Even if the DIP switch settings disable the daylight sensor, the software also will persistently detect the sensor head type, causing the luminaires to flash and signaling an issue.

### Wiring Diagram

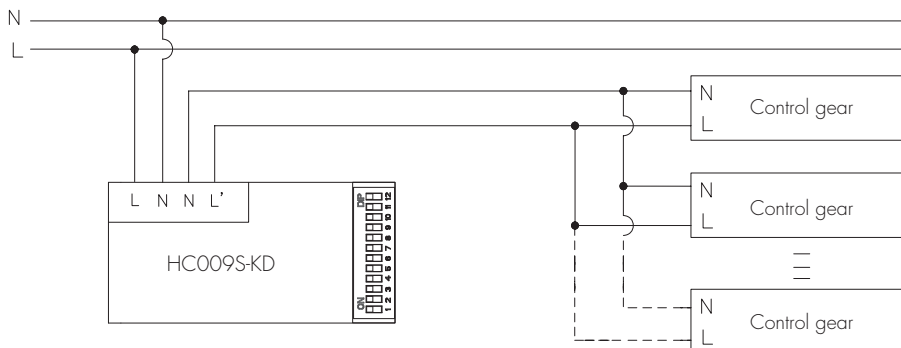

## Typical applications:

1. Office light, most of which have aluminium louvres and is impossible for microwave sensors to go through.
2. LED bulkhead or low bay, which has limited space and ordinary sensor is too big or too thick to be built in, also easy to cast shadow in the shade.

For linear T5, T8, TC-L lamps

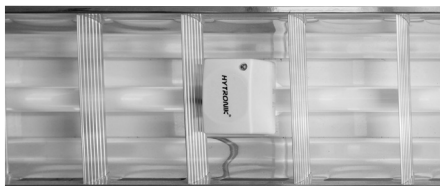

Most of the linear office lights have metal louvre, where microwave cannot penetrate through. An easy alternative solution is to use this detached sensor antenna head, grip on the T5 and T8 tube, and put the sensor main body behind the metal louvre, together with the ballast or driver.

For LED bulkhead

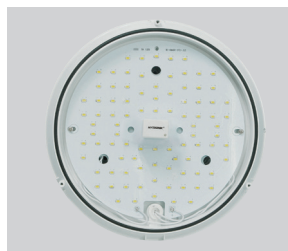

In such applications, only the detached small antenna is needed on the outer surface, while the sensor body and the driver/ballast can be hidden behind the panel. No shadow is cast in the shade.



## Functions and Features

### 1 On/off Control

This sensor is a motion switch, which turns on the light upon detection of motion, and turns off after a pre-selected hold-time when there is no movement. A daylight sensor is also built in to prevent the light from switching on when there is sufficient natural light.

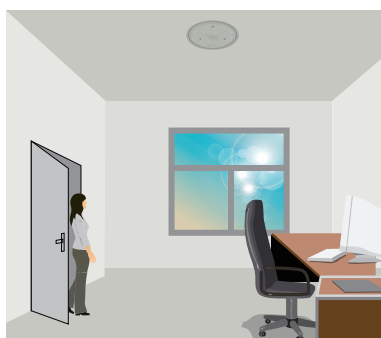

With sufficient natural light, the light does not switch on when presence is detected.

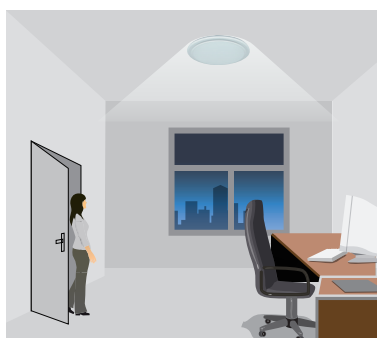

With insufficient natural light, the sensor switches on the light automatically when presence is detected.



The sensor switches off the light automatically after the hold-time when there is no motion detected.

### 2 Zero-cross Relay Operation

Designed in the software, sensor switches on/off the load right at the zero-cross point, to ensure that the in-rush current is minimised, enabling the maximum lifetime of the relay.

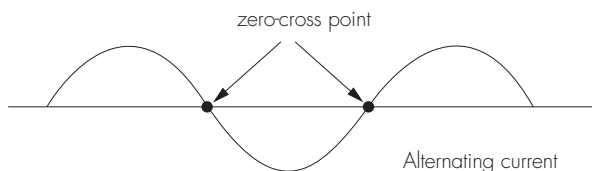

### 3 Loop-in and Loop-out Terminal

Double L N terminal makes it easy for wire loop-in and loop-out, and saves the cost of terminal block and assembly time.

## Detection Pattern

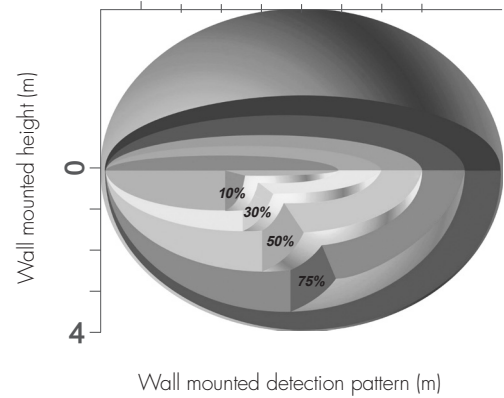
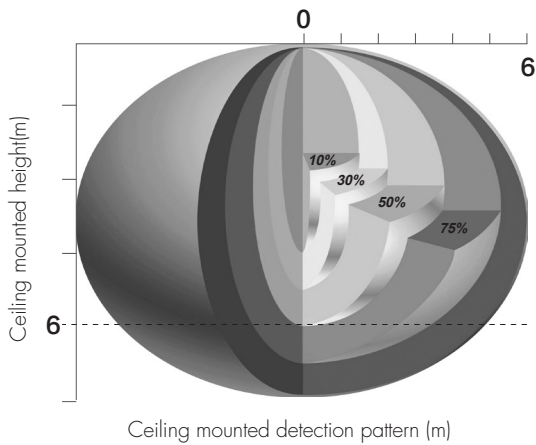

## DIP Switch Settings

9

### 1 Detection Range

Sensor sensitivity can be adjusted by selecting the combination on the DIP switches to fit precisely for each specific application.

	1	2	3	
I	●	●	●	100%
II	●	○	●	75%
III	○	○	●	50%
IV	○	●	○	25%
V	●	○	○	10%

I – 100%  
 II – 75%  
 III – 50%  
 IV – 25%  
 V – 10%

### 2 Hold Time

Select the DIP switch configuration for the light on-time after presence detection. This function is disabled when natural light is sufficient.

	1	2	3	4	
I	●	●	●	●	30min
II	○	○	○	●	20min
III	○	○	●	○	6min
IV	○	●	○	○	90s
V	●	○	○	○	30s
VI	○	○	○	○	10s

I – 30 min  
 II – 20 min  
 III – 6 min  
 IV – 90s  
 V – 30s  
 VI – 10s

### 3 Daylight Threshold

Set the level according to the fixture and environment. The light will not turn on if ambient lux level exceeds the daylight threshold preset.

*Please note that the ambient lux level refers to internal light reaching the sensor.*

Disabling the daylight sensor will put the sensor into occupancy detection only mode.

	1	2	3	4	
I	●	●	●	●	Disabled
II	○	○	●	○	50lux
III	○	●	○	○	30lux
IV	●	○	○	○	10lux
V	○	○	○	○	5lux

I – Disabled  
 II – 50 Lux  
 III – 30 Lux  
 IV – 10 Lux  
 V – 5 Lux

## Additional Information / Documents

- Regarding precautions for microwave sensor installation and operation, please kindly refer to [www.hytronik.com/download ->knowledge ->Microwave Sensors - Precautions for Product Installation and Operation](http://www.hytronik.com/download->knowledge->Microwave%20Sensors%20-%20Precautions%20for%20Product%20Installation%20and%20Operation)
- Regarding Hytronik standard guarantee policy, please refer to [www.hytronik.com/download ->knowledge ->Hytronik Standard Guarantee Policy](http://www.hytronik.com/download->knowledge->Hytronik%20Standard%20Guarantee%20Policy)