

Flush Mount PIR Motion Sensor

PIR

HIR27
Low-bay

HIR27/R
Reinforced Low-bay

HIR27/W
Wide range Low-bay

HIR27/H
High-bay

HIR27/UH
Ultra High-bay

HYTRONIK®

CE



emc



CB

Applications

Office, classroom and commercial interior spaces where DALI-2 control is required in small groups.

- Office / Commercial Lighting
- Classrooms
- Stairwells / Corridors

HIR27 with One DALI-2 Channel Output

Designed with a low profile for aesthetically demanding architectural projects whilst retaining the functionality expected of the latest lighting controls. Control to the light fixtures is provided via self-powered DALI communication.

Set-up of the sensor is carried out using a remote control handset with program memory allowing one-key commissioning where common settings are used for multiple devices.



HIR27



HIR27/R



HIR27/W



HIR27/H



HIR27/UH

Features

- DALI dimming control based upon occupancy (also known as corridor function).
- Daylight harvest function to regulate light output for maintaining required lux level.
- Store settings in the remote for easy commissioning when programming multiple sensors.
- Intelligent photocell - lights and sensors only operate when needed, natural light has priority.
- Synchronisation terminal for grouping of sensors.
- Black & White & Gray metal surface mount box option
- Two types of blind inserts / blanking plates
- User-friendly design for installation
- High bay version available (up to 21m in height)
- 5-year warranty

Technical Data

Input Characteristics	
Operating voltage	220~240VAC 50/60Hz
Stand-by power	<0.5W
DALI bus power supply	I guaranteed: 64mA I max.: 80mA U rated: 16VDC
Warming-up	Appr. 20s

Safety and EMC	
EMC standard (EMC)	EN55015, EN61000, EN61547
Safety standard (LVD)	EN60669-1, EN60669-2-1, AS/NES60669-1/-2-1
Certification	CB, CE, EMC, LVD, RCM ROHS compliance

Sensor Data	
Sensor Model	PIR detection
Detection range (Max.)* HIR27	Installation Height : 6m Detection Range(Ø) : 9m
Detection range (Max.)* HIR27/R	Installation Height : 6m Detection Range(Ø) : 10m
Detection range (Max.)* HIR27/W	Installation Height : 6m Detection Range(Ø) : 18m
Detection range (Max.)* HIR27/H	Installation height: 1.5m (forklift) 1.2m (person) Detection range (Ø): 24m
Detection range (Max.)* HIR27/UH	Installation height: 21m Detection range (Ø): 28m
Detection angle	360°
Sensitivity	10% / 50% / 75% / 100%

Environment	
Operation temperature	Ta: -20°C ~ +50°C
IP rating	IP20 / IP54
IP rating (facial part)	IP54

*IP54 (facial part) only for lens of standard, /R, /H, /UH

Mechanical Structure

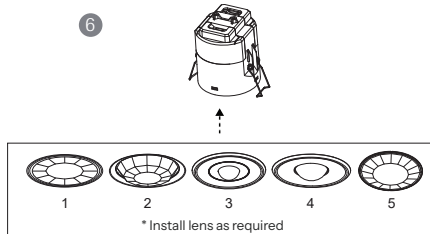
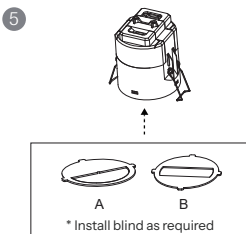
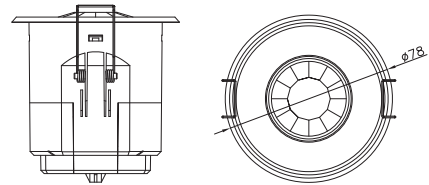
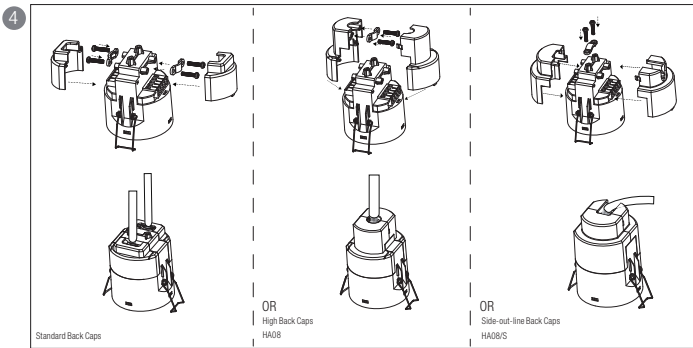
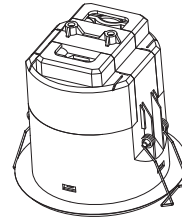
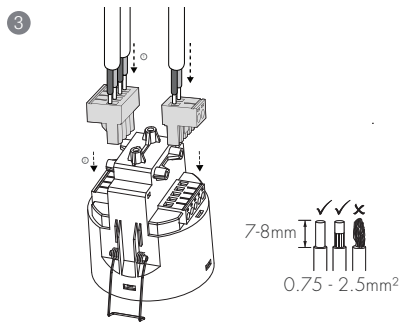
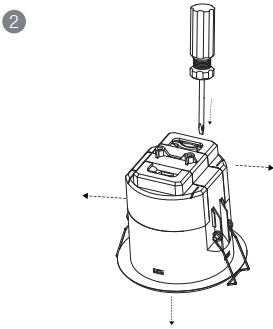
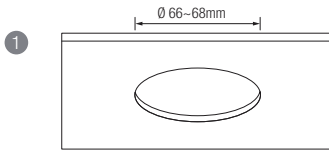

1. Ceiling (drill hole \varnothing 66~68mm).
2. Carefully prise off the Back Caps.
3. Make connections to the pluggable terminal blocks.
4. Secure the cables with screws for better stability. Three types of Back Caps are available (Standard, HA08, and HA08/S).
5. Fit detection blind (if required).
6. Fit desired lens, clip fascia to body (this step is not applicable for /UH).
7. Bend back springs and Insert into ceiling.

*The standard back cap is designed for the installation of two cables.
 HA08 is a high back cap, allows cables to exit upwards.
 HA08/S is designed for sideways cable exits.

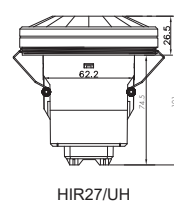
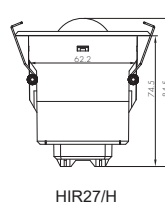
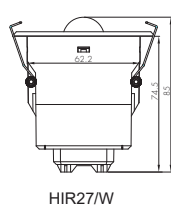
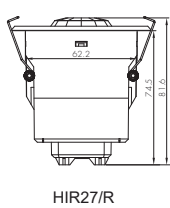
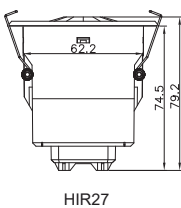
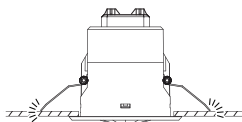
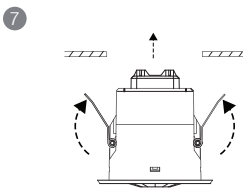

Wiring Diagram

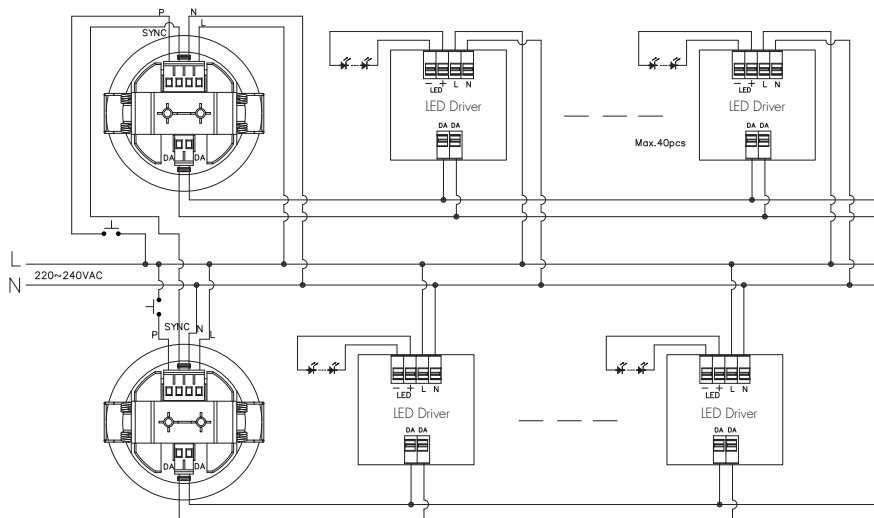

Note:
Maximum sync cable length 100m

Wire Preparation

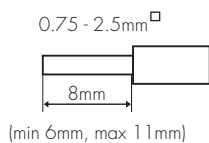
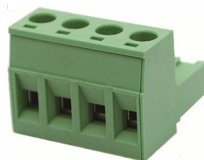

Pluggable screw terminal. It is recommended to make connections to the terminal before fitting to the sensor.

1. 200 metres (total) max. for 1 mm² CSA (T_a = 50 C)
2. 300 metres (total) max. for 1.5 mm² CSA (T_a = 50 C)

Optional Accessories For Water-Proof

Big and small silicon gasket used to make IP54 degree protection (mounted into HA09 housing for ceiling mount)

Small silicon water-proof gasket dimension(size:mm)

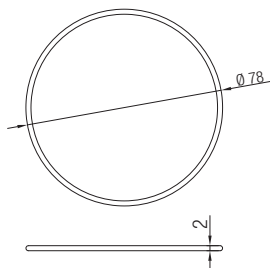

Big silicon water-proof gasket dimension(size:mm)

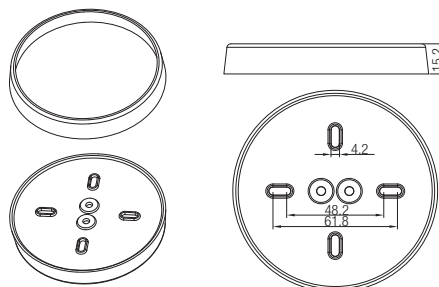

Note: The small silicon water-proof gasket is not suitable for HIR27/W and HIR27/UH
The Big silicon water-proof gasket is not suitable for HIR27/W

1. HIR27 (Low-bay)



HIR27: Low-bay flat lens detection pattern for **single person** @ Ta = 20°C

(Recommended ceiling mount installation height **2.5m-6m**)

A: Tangential movement	B: Radial movement	Mount height	Tangential (A)	Radial (B)
		2.5m	max 50m ² (Ø = 8m)	max 13m ² (Ø = 4m)
		3m	max 64m ² (Ø = 9m)	max 13m ² (Ø = 4m)
		4m	max 38m ² (Ø = 7m)	max 13m ² (Ø = 4m)
		5m	max 38m ² (Ø = 7m)	max 13m ² (Ø = 4m)
		6m	max 38m ² (Ø = 7m)	max 13m ² (Ø = 4m)

Optional Accessory --- Ceiling/Surface Metal Mount Box: HA09/W, HA09/B, HA09/G

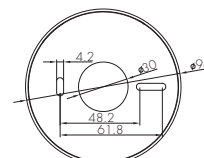
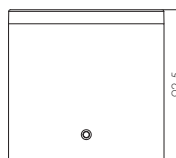
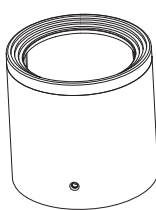

Optional Accessory --- HA08

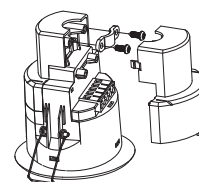
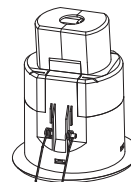
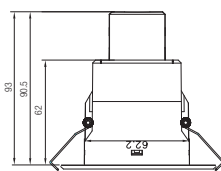

*Note: Optional Accessory HA09 & HA08 can not be used together.

Optional Accessory --- Blind Insert for Blocking Certain Detection Angles

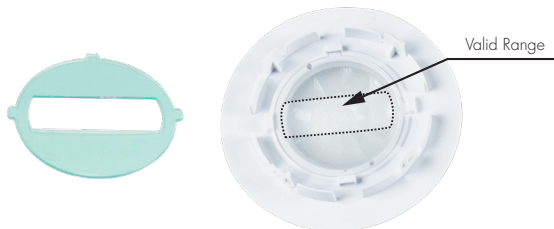

Blind Option 1 --- Aisle Detection

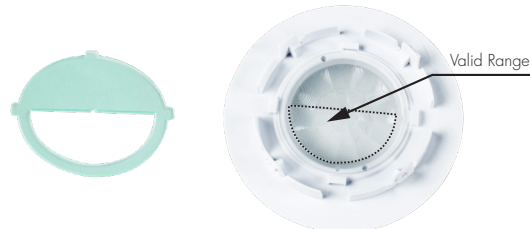

Blind Option 2 --- 180° Detection

2. HIR27/R (Reinforced Low-bay)



HIR27/R: Low-bay convex lens detection pattern for **single person** @ Ta = 20°C
(Recommended ceiling mount installation height **2.5m-6m**)

A: Tangential movement	B: Radial movement	Mount height	Tangential (A)	Radial (B)
		2.5m	max 79m ² (∅ = 10m)	max 20m ² (∅ = 5m)
		3m	max 79m ² (∅ = 10m)	max 20m ² (∅ = 5m)
		4m	max 64m ² (∅ = 9m)	max 20m ² (∅ = 5m)
		5m	max 50m ² (∅ = 8m)	max 20m ² (∅ = 5m)
		6m	max 50m ² (∅ = 8m)	max 20m ² (∅ = 5m)

Optional Accessory --- Ceiling/Surface Metal Mount Box: HA09/W, HA09/B, HA09/G

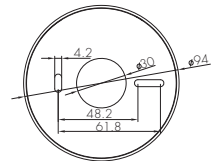
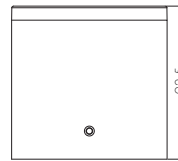
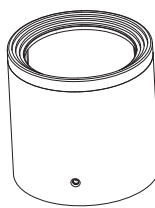

Optional Accessory --- HA08

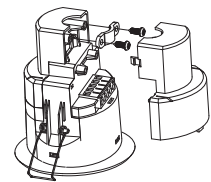
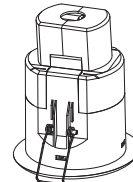
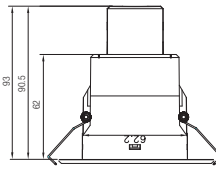

*Note: Optional Accessory HA09 & HA08 can not be used together.

Optional Accessory --- Blind Insert for Blocking Certain Detection Angles

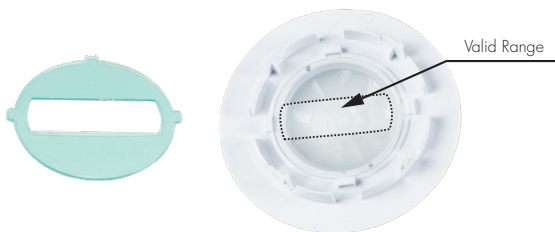

Blind Option 1 --- Aisle Detection

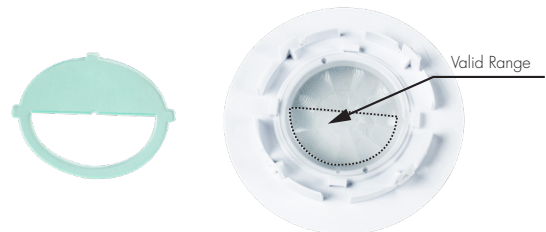

Blind Option 2 --- 180° Detection

3. HIR27/W (Wide range Low-bay)



HIR27/W: Low-bay convex lens detection pattern for **single person** @ $T_a = 20^\circ\text{C}$

(Recommended ceiling mount installation height **2.5m-6m**)

A: Tangential movement	B: Radial movement	Mount height	Tangential (A)	Radial (B)
		2.5m	max 254m ² (∅ = 18m)	max 28m ² (∅ = 6m)
		3m	max 254m ² (∅ = 18m)	max 28m ² (∅ = 6m)
		4m	max 154m ² (∅ = 14m)	max 28m ² (∅ = 6m)
		5m	max 113m ² (∅ = 12m)	max 28m ² (∅ = 6m)
		6m	max 79m ² (∅ = 10m)	max 13m ² (∅ = 4m)

Optional Accessory -- Ceiling/Surface Metal Mount Box: HA09/W, HA09/B, HA09/G

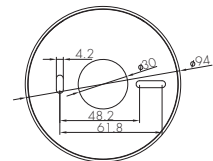
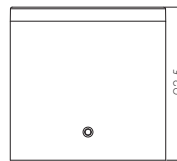
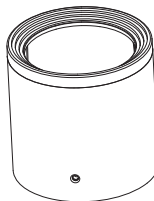

Optional Accessory --- HA08

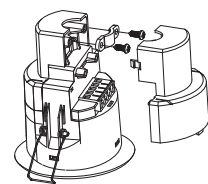
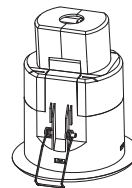
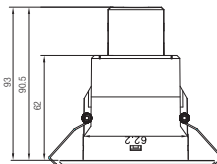

*Note: Optional Accessory HA09 & HA08 can not be used together.

3. HIR27/H (High-bay)



HIR27/H: High-bay lens detection pattern for forklift @ Ta = 20°C

(Recommended ceiling mount installation height **10m-15m**)

A: Tangential movement	B: Radial movement	Mount height	Tangential (A)	Radial (B)
		10m	max 380m ² (Ø = 22m)	max 201m ² (Ø = 16m)
		11m	max 452m ² (Ø = 24m)	max 201m ² (Ø = 16m)
		12m	max 452m ² (Ø = 24m)	max 201m ² (Ø = 16m)
		13m	max 452m ² (Ø = 24m)	max 177m ² (Ø = 15m)
		14m	max 452m ² (Ø = 24m)	max 133m ² (Ø = 13m)
		15m	max 452m ² (Ø = 24m)	max 113m ² (Ø = 12m)



HIR27/H: High-bay lens detection pattern for single person @ Ta = 20°C

(Recommended ceiling mount installation height **2.5m-12m**)

A: Tangential movement	B: Radial movement	Mount height	Tangential (A)	Radial (B)
		2.5m	max 50m ² (Ø = 8m)	max 7m ² (Ø = 3m)
		6m	max 104m ² (Ø = 11.5m)	max 7m ² (Ø = 3m)
		8m	max 154m ² (Ø = 14m)	max 7m ² (Ø = 3m)
		10m	max 227m ² (Ø = 17m)	max 7m ² (Ø = 3m)
		11m	max 269m ² (Ø = 18.5m)	max 7m ² (Ø = 3m)
		12m	max 314m ² (Ø = 20m)	max 7m ² (Ø = 3m)

Optional Accessory -- Ceiling/Surface Metal Mount Box: HA09/W, HA09/B, HA09/G

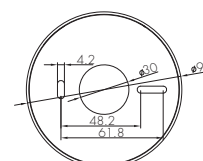
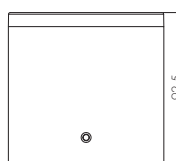

Optional Accessory --- HA08

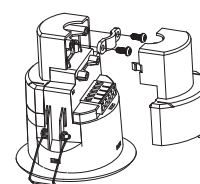
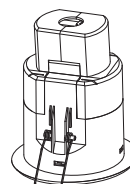
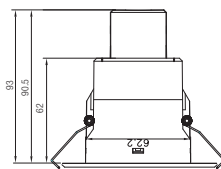

*Note: Optional Accessory HA09 & HA08 can not be used together.

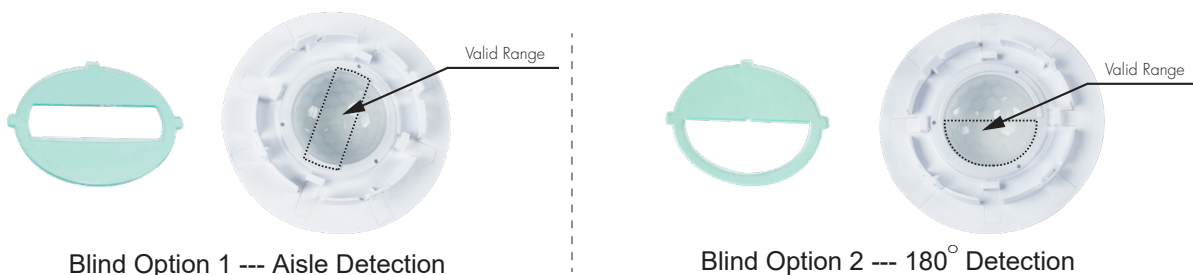

Blind Option 1 --- Aisle Detection

Blind Option 2 --- 180° Detection

5. HIR27/UH (Ultra High-bay)



HIR27/UH: Ultra High-bay convex lens detection pattern for **single person** @ $T_a = 20^\circ\text{C}$

(Recommended ceiling mount installation height **3m-21m**)

Noted: The different humidity levels in the environment can affect the sensor detection range.

		Mount height	Tangential (A)	Radial (B)
<p>A: Tangential movement</p>	<p>B: Radial movement</p>	3m	max12.5m ² (Ø = 4m)	max12.5m ² (Ø = 4m)
		6m	max50m ² (Ø = 8m)	max28m ² (Ø = 6m)
		9m	max113m ² (Ø = 12m)	max50m ² (Ø = 8m)
		12m	max201m ² (Ø = 16m)	max79m ² (Ø = 10m)
		15m	max314m ² (Ø = 20m)	max113m ² (Ø = 12m)
		18m	max452m ² (Ø = 24m)	max113m ² (Ø = 12m)
		21m	max615m ² (Ø = 28m)	max113m ² (Ø = 12m)

Optional Accessory --- Ceiling/Surface Metal Mount Box: HA09/W, HA09/B, HA09/G

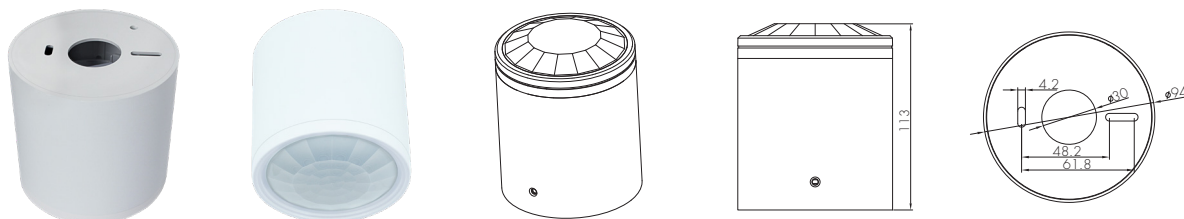

Optional Accessory --- HA08

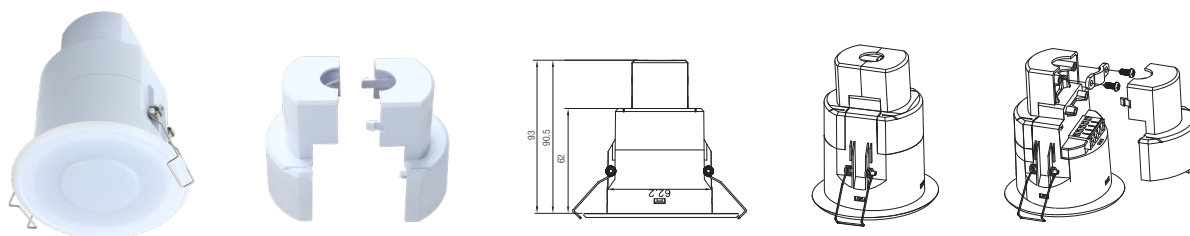

*Note: Optional Accessory HA09 & HA08 can not be used together.

1 Daylight Harvest



Light will not switch on when natural light is sufficient, even there is motion detected.

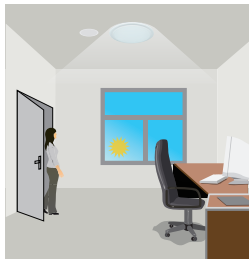

The light switches on automatically with presence when natural light is insufficient.

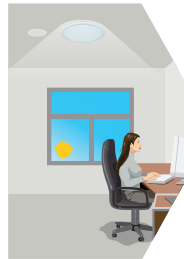

The light turns on at full or dims to maintain the lux level. The light output regulates according to the level of natural light available.

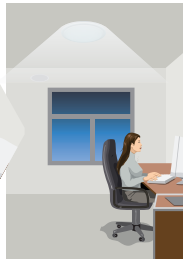
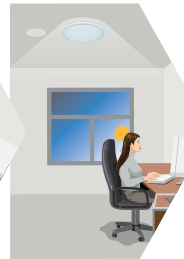
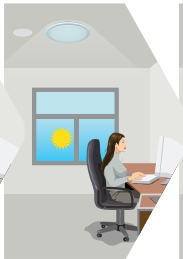

The light switches off when the ambient natural light is sufficient.

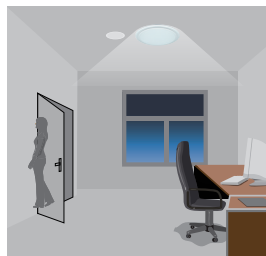

The light dims to stand-by period after hold-time and stays on selected minimum dimming level.

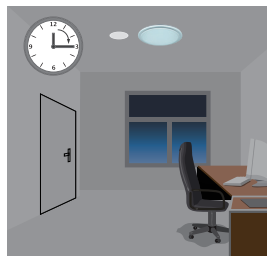

The light switches off completely after the stand-by period.

2 Manual Override

With the help of push-switch, this sensor can be over-riden by the end-user to manually switch on/off the light, or adjust the target lux level by push-switch, which makes the product more user-friendly and offers more options to fit some extra-ordinary demands:

- * Short Push (< 1 s): on/off function;
 - On → Off: the light turns off immediately and cannot be triggered ON by motion until the expiration of pre-set hold-time. After this period, the sensor goes back to normal sensor mode.
 - Off → On: the light turns on and goes to sensor mode, no matter if ambient Lux level exceeds the daylight threshold or not.
- * Long Push (> 1 s): adjust the target lux level by turning the light up or down. Both the adjustment on remote control and push switch can overwrite each other. The last adjustment remains in memory.

Note: if end-user do not want this manual override function, just leave the “push” terminal unconnected to any wire.

3 Semi-auto Mode (Absence Detection)

Selecting this mode will activate the following logic:

Manual on - The lights will not switch on until they have manually been switched on at the wall switch. The occupancy sensor is inactive whilst the lights are off.

Auto off - When the lights are on, the sensor becomes active and monitors the space for activity. Once the area is vacated (absence selection), the sensor will automatically switch off the lights if the last person out forgets to switch off the light manually.

Note: The wall switch can be assigned to function 2 or 3, but not both. The default function is manual override.

4 Detection Synchronisation Function

By connecting the “SYNC” terminals in parallel (see wiring diagram), no matter which sensor detects motion, all HIR27 in the group will turn on the lights when surrounding natural light is below the daylight threshold. The detection area could be widely enlarged in this way.

Settings (Remote Control HRC-11)

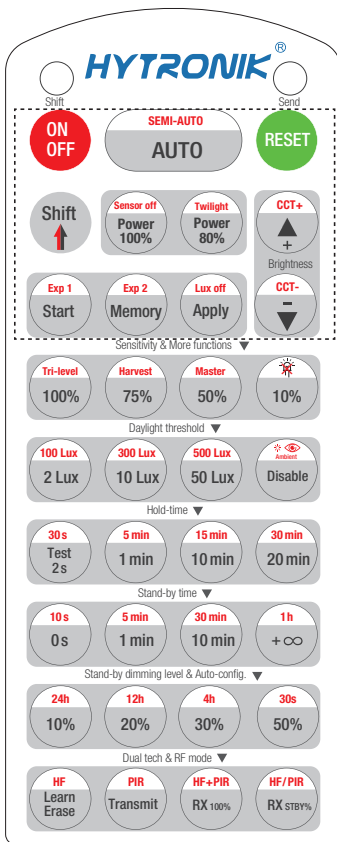

HRC-11

ON/OFF	Press button "ON/OFF" to select permanent ON or permanent OFF mode. * Press button "AUTO"/ "RESET" to exit this mode.
RESET	Press button "RESET", all settings go back to default. The default settings are: Auto mode; Hold-time 5min; Daylight sensor 100 lux; Stand-by time 10min; Stand-by dimming level: 20%; Lux off activated;
Shift	Press button "Shift", the LED on the top left corner is on to indicate mode selection. All values / settings in RED are valid for 20 seconds.
AUTO	Press button "AUTO" to initiate automatic mode. The sensor starts working and all settings remain as before the light is switched ON/OFF;
SEMI-AUTO	1. Press button "Shift", the red LED on. 2. Press button "SEMI-AUTO" to initiate Semi-auto mode. The sensor is only activated with the manual press of push switch. To exit this mode, simply press button "AUTO"/ "RESET". <i>For Sensor LED indicator references: Remains on 2s, initiate "Semi-auto" mode from "Auto" mode.</i>
Power 100% 80%	Press buttons in zone "Power out" to select the light output at 80% (at initial 10,000 hours) or 100%.
Sensor off	This key is not applicable on this product.
Twilight	1. Press button "Shift", the red LED on. 2. Press button "Twilight", the function of movement detection is disabled, but the function of photocell is still working, and the product becomes a pure dusk/ dawn daylight sensor. To exit from "Twilight" mode, press button "AUTO"/"SEMI-AUTO"/"RESET".
CCT+ CCT-	Press these two buttons to adjust the light output brightness and set a new target lux level. The daylight sensor can measure ambient daylight level and ignore the LED light, so as to calculate how much artificial light is needed to maintain the target lux level.
CCT+ CCT-	This key is not applicable on this product.
Start Memory Apply	1. Press button "Start" to program. 2. Select the buttons in "Detection range", "Daylight threshold", "Hold-time", "Stand-by time", "Stand-by dimming level" to set all parameters. 3. Press button "Memory" to save all the settings programmed in the remote control. 4. Press button "Apply" to set the settings to each sensor unit(s). <i>For example, to set detection range 100%, daylight threshold Disable, hold-time 5min, stand-by time +∞, stand-by dimming level 30%, the steps should be: Press button "Start", button "100%", "Disable", "Shift", "5min", "Shift", "+∞", "30%", "Memory". By pointing to the sensor unit(s) and pressing "Apply", all settings are passed on the sensor(s).</i>
Lux off	The "Lux off" function is activated as default. When the ambient lux level exceeds the target level continuously for more than 5 minutes, the lights will be turned off. In AUTO /SEMI-AUTO/Twilight modes, to disable "Lux off": 1. Press "Shift" button first, the red LED on. 2. Press "Lux off" button, the "Lux Off" function will be deactivated. The lights will not turn off even when the ambient lux level exceeds the target lux level but will dim down the brightness to the stand-by time level. <i>For Sensor LED indicator references: 1.Fast flash 1s, "Lux off" function activated. 2.Remains on 2s, "Lux off" function deactivated.</i>
Exp 1 Exp 2	"Exp" refer to Expansion, these two buttons are reserved functions and pending future development.

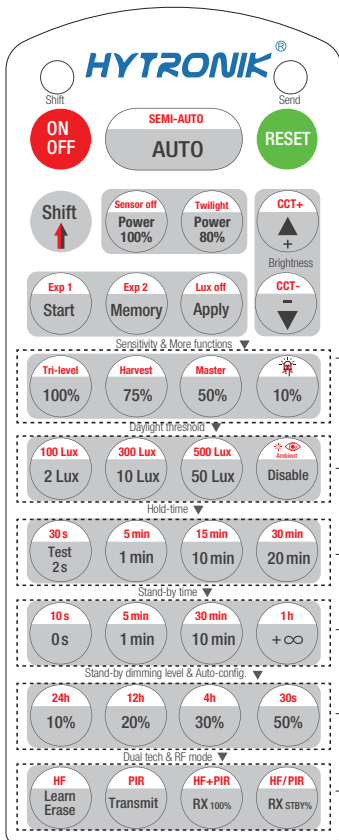

HRC-11

Sensitivity & More functions	
100% 75% 50% 10%	In AUTO /SEMI-AUTO modes, press buttons in zone "Detection range" to set detection range at 100%/75%/50%/10%.
Tri-level Harvest	This key is not applicable on this product.
Master	This key is not applicable on this product.
Daylight threshold	
2 Lux 100 Lux 10 Lux 300 Lux 50 Lux 500 Lux Disable	Press buttons in zone "Daylight threshold" to set daylight sensor at 2Lux/ 10Lux / 50Lux / 100Lux / 300Lux/500Lux / Disable. <i>Note: To set daylight sensor at 100Lux / 300Lux/500Lux , press "Shift" button first.</i>
Ambient	1. Press button "Shift", the red LED on. 2. Press button "Ambient", the surrounding lux level is sampled and set as daylight threshold / target Lux level.
Hold-time mode	
Test 2s 30s 1 min 5 min 10 min 15 min 20 min 30 min	In AUTO /SEMI-AUTO modes, press buttons in zone "hold-time" to set the hold-time at 2s / 30s / 1min / 5min / 10min / 15min / 20min / 30min. <i>Note: 1. To set hold-time at 30s / 5min / 15min / 30min, press "Shift" button first. 2. 2s is for testing purpose only, stand-by period and daylight sensor settings are disabled in this mode. * To exit from Test mode, press button "RESET" or any button in "Hold-time".</i>
Stand-by time mode	
0s 10s 1 min 5 min 10 min 30 min +∞ 1h	Press buttons in zone "stand-by time" to set the stand-by period at 0s / 10s / 1min / 5min / 10min / 30min / 1h / +∞. <i>Note: 1. To set stand-by-time at 10s/ 5min / 30min / 1h, press "Shift" button first. 2. "0s" means on/off control; 3. "+∞" means bi-level control, the fixture is 100% on when there is motion detected, and remains at the stand-by dimming level when no presence after motion hold-time. Only when the stand-by time is set in "+∞" and the ambient lux level is below the target lux level, the lux will auto-on.</i>
Stand-by dimming level & Auto-config.	
10% 20% 30% 50%	Press the button in zone "stand-by dimming level" to set the stand-by dimming level at 10% / 20% / 30% / 50%.
24h 12h 4h 30s	1.Press button "Shift" ,the red LED on. 2.Select a time period and the sensor will do light level measurement and determine/save the lowest light level (commission line) with 100% light on, so as to set the target lux level automatically. <i>Note: 1. Make sure the light level measurement covers the night time. 2. The fixture will go into sensor mode after the measurement, all sensor setting remain unchanged.</i>
Dual tech & RF mode	
Learn Erase	This key is not applicable on this product.
Transmit	This key is not applicable on this product.
HF PIR HF+PIR HF/PIR	This key is not applicable on this product.

Additional Information / Documents

1. Regarding precautions for PIR sensor installation and operation, please kindly refer to [www.hytronik.com/download ->knowledge ->PIR Sensors - Precautions for Product Installation and Operation](http://www.hytronik.com/download->knowledge->PIR+Sensors+-+Precautions+for+Product+Installation+and+Operation)
2. Regarding Hytronik standard guarantee policy, please refer to [www.hytronik.com/download ->knowledge ->Hytronik Standard Guarantee Policy](http://www.hytronik.com/download->knowledge->Hytronik+Standard+Guarantee+Policy)