

## DALI HF Sensor

### HCD418/I

Independent DALI-2 sensor with Photocell Advance™

# HYTRONIK®



## Applications

Occupancy detector with tri-level control suitable for indoor use.

Suitable for building into the fixture:

- Office / Commercial Lighting
- Classroom
- Meeting Room

Use for retrofit and new luminaire designs/installations



## Features

- 32mA DALI-2 Broadcast output
- Special photocell to measure and differentiate natural light from LED light from behind the fixture cover
- Tri-level dimming control based upon occupancy (also known as corridor function)
- Synchronised dimming with multiple sensor circuits
- One-key commissioning via programmable remote control
- DALI dimming control method (DALI power supply circuit included)
- 5 Year, 50,000hr Warranty

## Technical Data

Input Characteristics	
Mains voltage	220~240VAC 50/60Hz
Stand-by power	<0.5W
Output	I guaranteed: 32mA I max: 40mA U rated: 15VDC
Warming-up	20s

Safety and EMC	
EMC standard (EMC)	EN55015, EN61000
Safety standard (LVD)	EN60669, AS/NZS60669
Radio Equipment (RED)	EN300440, EN301489, EN62479
Certification	Semko, CB, CE, EMC, RED, RCM

Sensor Data	
Sensor principle	High Frequency (microwave)
Operation frequency	5.8GHz +/- 75MHz
Transmission power	<2mW
Detection range	Max. (Ø x H) 12m x 5m
Detection angle	30° ~ 150°
Sensitivity	100% / 75% / 50% / 10%
Hold time	5s ~ 30min (selectable)
Daylight threshold	2Lux / 10Lux / 50Lux / 100Lux / 300Lux / 500Lux / Disable
Stand-by period	0s ~ 1h, +∞ (selectable)
Stand-by dimming level	10% / 20% / 30% / 50%

Environment	
Operation temperature	Ta: -20°C ~ +60°C
Storage temperature	-35°C ~ +80°C
Relative humidity	0 ~ 90%
Insulation	Class II
IP rating	IP20

## Mechanical Structure & Dimensions

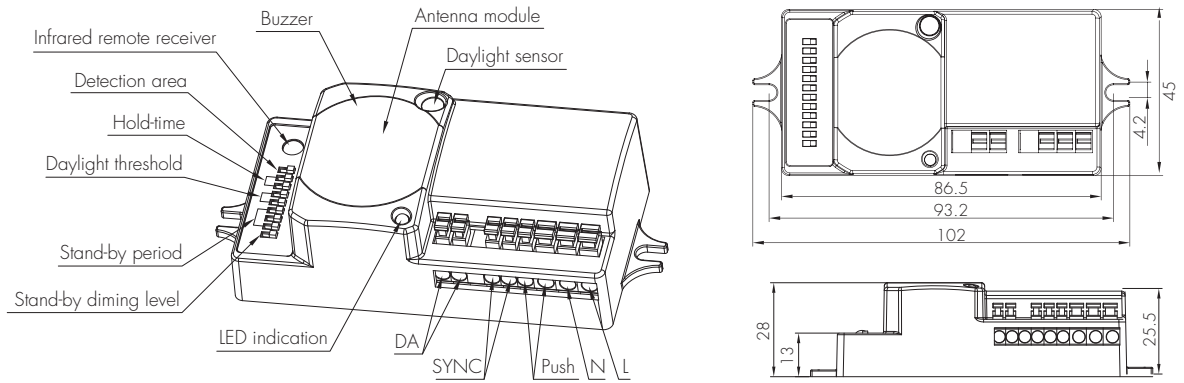

This sensor is specially designed for small scale, decentralised retrofit project, which contains a DALI power supply circuit and gives DALI output to the DALI driver to carry out on/off and dimming command. No extra DALI power supply is needed.

## Wiring Diagram

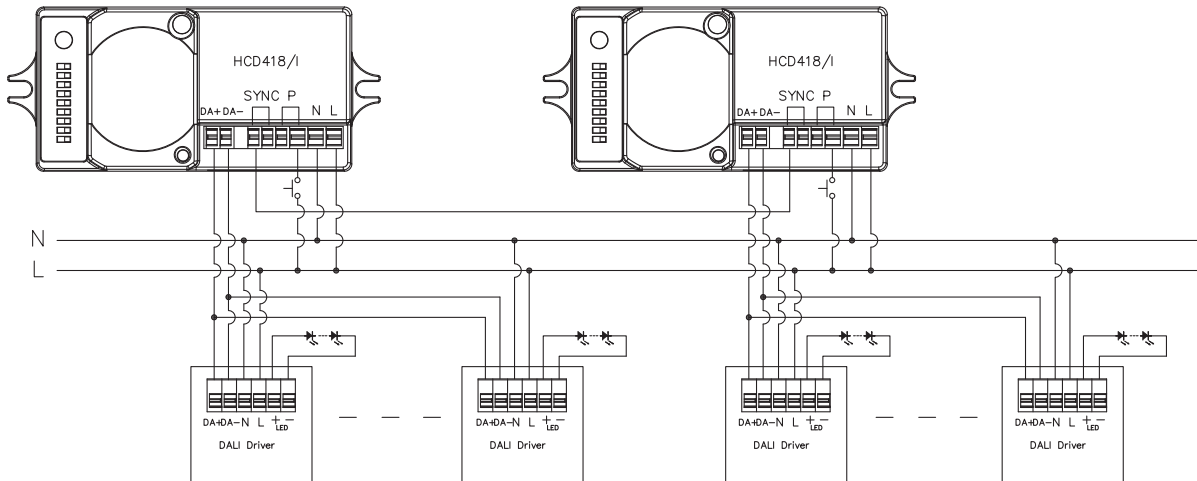

## Functions and Features

### 1 Photocell Advance™ Function

It's well known that LED lights have a totally different spectrum to natural light. Hytronik uses this principle and comes up with special photocell and sophisticated software algorithm to measure and differentiate natural light from LED light from behind the fixture cover, so that this photocell can ignore internal LED light and only respond to the natural light outside.

Our technology has no infringement to the existing patents in the market.

#### Settings on this demonstration:

Hold-time: 10min

Daylight threshold: 50lux

Stand-by dimming level: 10%

Stand-by period: +∞

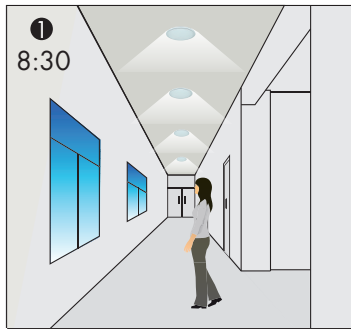

With insufficient natural light, the light switches on at 100% when there is motion detected.



The light turns off completely whenever natural light reaches above pre-set daylight threshold, even with presence.

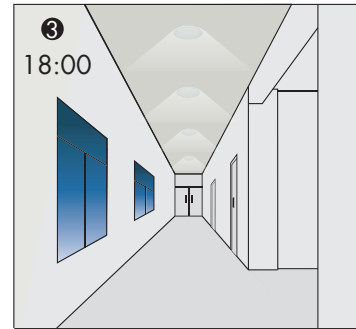

The light turns on at dim level automatically when natural light lux level drops below pre-set daylight threshold (no motion).

### 2 Synchronisation Function

By connecting the "SYNC" terminals in parallel (maximum 10pcs, see wiring diagram), no matter which sensor detects motion, all HCD418/I in the group will turn on the lights (ambient natural light is below daylight threshold). The detection area is widely enlarged in this way while other settings such as hold-time, stand-by period, stand-by dimming level and daylight threshold on each individual unit stay the same.

### 3 Tri-level Control (Corridor Function)

Hytronik builds this function inside the motion sensor to achieve tri-level control, for some areas which require a light change notice before switch-off. The sensor offers 3 levels of light: 100%→dimmed light→off; and 2 periods of selectable waiting time: motion hold-time and stand-by period; Selectable daylight threshold and freedom of detection area.

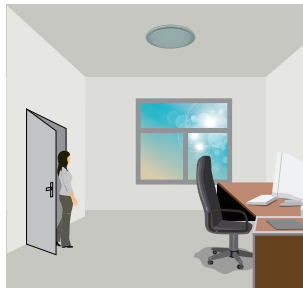

With sufficient natural light, the light does not switch on when presence is detected.

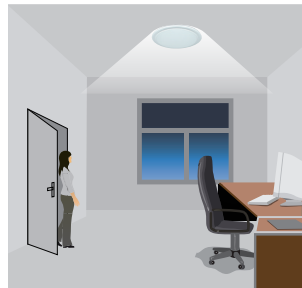

With insufficient natural light, the sensor switches on the light automatically when presence is detected.

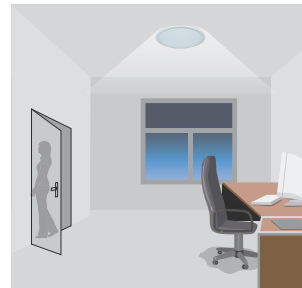

After hold-time, the light dims to stand-by level if the surrounding natural light is below the daylight threshold.



Light switches off automatically after the stand-by period elapses.

### 4 Manual Override

This sensor reserves the access of manual override function for end-user to switch on/off, or adjust the target lux level by push-switch, which makes the product more user-friendly and offers more options to fit some extra-ordinary demands:

\* Short Push (< 1s): on/off function;

On → Off: the light turns off immediately and cannot be triggered ON by motion until the expiration of pre-set hold-time. After this period, the sensor goes back to normal sensor mode.

Off → On: the light turns on and goes to sensor mode, no matter if ambient Lux level exceeds the daylight threshold or not.

\* Long Push (> 1s): adjust the target lux level by turning the light up or down. Both the adjustment on RC and push switch can overwrite each other, the last adjustment remains in memory.

*Note: if end-user do not want this manual override function, just leave the "push" terminal unconnected to any wire.*

### 5 Semi-auto Mode (Absence Detection)

It is easy to forget to switch off the light, in office, corridor, even at home. And in many other cases, people do not want to have a sensor to switch on the light automatically, for example, when people just quickly pass-by, there is no need to have the light on. The solution is to apply this "absence detector": motion sensor is employed, but only activated on the manual press of the push switch, the light keeps being ON in the presence, and dims down in the absence, and eventually switches off in the long absence.

This is a good combination of sensor automation and manual override control, to have the maximum energy saving, and at the same time, to keep efficient and comfortable lighting.



The light does not switch on when there is presence being detected.



Short push to activate the sensor and switch on the light



The light turns on full, and the sensor stays in sensor mode.



The light keeps being ON during the presence.

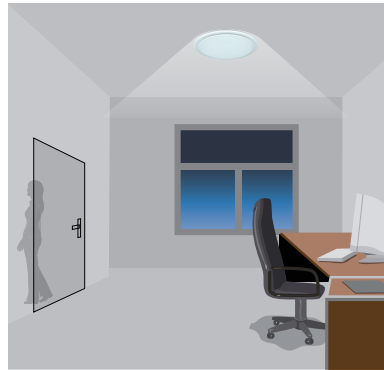

People left, the light dims to stand-by level after the hold-time.



The light switches off automatically after the stand-by period elapses.

Note: end-user can choose either function 4 or function 5 for application. Default function is manual override.

### Detection Pattern

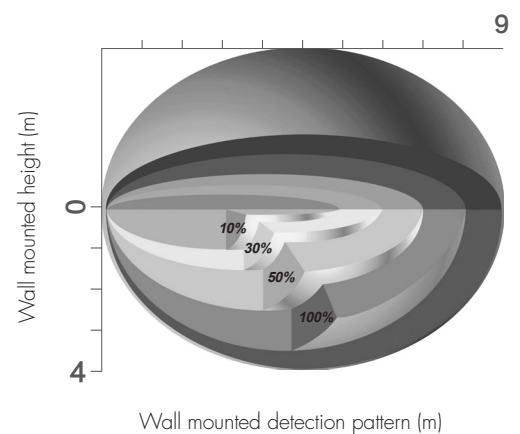
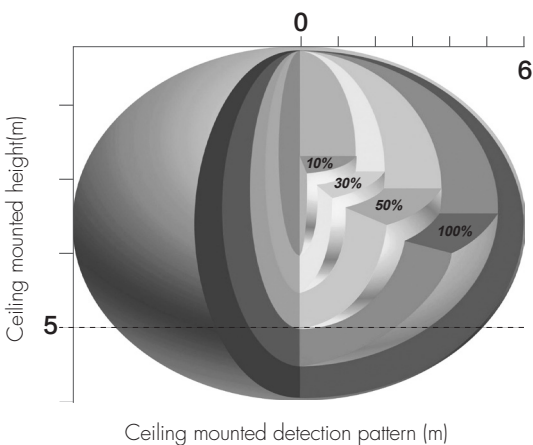

## DIP Switch Settings

### 1 Detection Range

Sensor sensitivity can be adjusted by selecting the combination on the DIP switches to fit precisely for each specific application.

	1	
I	●	100%
II	○	50%



I – 100%  
II – 50%

### 2 Hold Time

Select the dip switch configuration for the full brightness on-time after presense detection.

*Please note that this function is disabled when the natural daylight exceeds the daylight threshold setting for more than 5 minutes.*

	2	3	
I	●	●	5s
II	●	○	3min
III	○	●	10min
IV	○	○	30min



I – 5s  
II – 3min  
III – 10min  
IV – 30min

### 3 Daylight Threshold

Set the level according to the fixture and environment. The light will not turn on if ambient lux level exceeds the daylight threshold preset. Please note the ambient lux level refers to internal light reaching the sensor.

Disabling the daylight sensor will put the sensor into occupancy detection only mode.

	4	5	
I	●	●	Disable
II	●	○	50Lux
III	○	●	10Lux
IV	○	○	2Lux



I – Disable  
II – 50Lux  
III – 10Lux  
IV – 2Lux

### 4 Stand-by period (corridor function)

This is the time period you would like to keep at the low light output level before it is completely switched off in the long absence of people.

*Note: "0s" means on/off control;*

*"+ ∞" means the stand-by time is infinite and the fixture is effectively controlled by the daylight sensor, automatic on/off operation based upon daylight). Selecting other time periods will disable 'automatic on' operation and the photocell is used only to turn off the fixture automatically.*

	6	7	8	
I	●	●	●	0s
II	●	●	○	10s
III	●	○	●	1min
IV	●	○	○	5min
V	○	●	●	10min
VI	○	●	○	30min
VII	○	○	●	1h
VIII	○	○	○	+∞



I – 0s  
II – 10s  
III – 1min  
IV – 5min  
V – 10min  
VI – 30min  
VII – 1h  
VIII – +∞

### 5 Stand-by dimming level

The setting is used to select the desired dimmed light level used in periods of absence for enhanced comfort and safety.

	9	
I	●	10%
II	○	30%



I – 10%  
II – 30%

## Settings (Remote Control HRC-11)

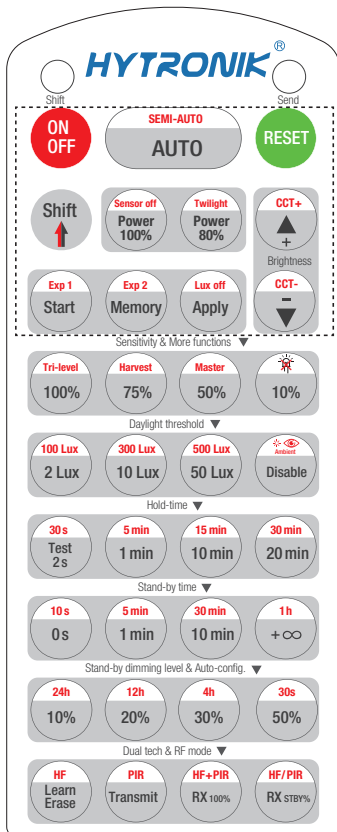

HRC-11

	Press button "ON/OFF" to select permanent ON or permanent OFF mode. * Press button "AUTO" / "RESET" / "Ambient" to exit this mode.
	In any state, Press button "RESET", the detector receiver will reset all settings and go back to the default: Exit ON/OFF mode; SEMI-AUTO mode; Twilight mode; Restore to DIP Settings. The default DIP Switch setting is: Induction range 100%, induction delay 5S, waiting time 10S, waiting brightness 10%, light control is not controlled <i>The default settings can be customized.</i>
	Press button "Shift", the LED on the top left corner is on to indicate mode selection. All values / settings in RED are valid for 20 seconds.
AUTO	Press button "AUTO" to exit ON/OFF mode and SEMI-AUTO mode and initiate AUTO mode.
SEMI-AUTO	Press button "SEMI-AUTO" to initiate Semi-auto mode. The sensor is only activated with the manual press of push switch. To exit this mode, simply press button "RESET" or "Auto".  <i>For Sensor LED indicator references: Remains on 2s, initiate "Semi-auto" mode from "Auto" mode.</i>
Power 100% 80%	Press buttons in zone "Power out" to select the light output at 80% (at initial 10,000 hours) or 100%.
Sensor off Twilight	This key is not applicable on this product.
	Press these two buttons to adjust the light output brightness.
CCT+ CCT-	This key is not applicable on this product.
Start Memory Apply	<ol style="list-style-type: none"> <li>1. Press button "Start" to program.</li> <li>2. Select the buttons in "Detection range", "Daylight threshold", "Hold-time", "Stand-by time", "Stand-by dimming level" to set all parameters.</li> <li>3. Press button "Memory" to save all the settings programmed in the remote control.</li> <li>4. Press button "Apply" to set the settings to each sensor unit(s).</li> </ol> <p><i>For example, to set detection range 100%, daylight threshold Disable, hold-time 5min, stand-by time +∞, stand-by dimming level 30%, the steps should be:</i> <i>Press button "Start", button "100%", "Disable", "Shift", "5min", "Shift", "+∞", "30%", "Memory". By pointing to the sensor unit(s) and pressing "Apply", all settings are passed on the sensor(s).</i></p>
Lux off	This key is not applicable on this product.
Exp 1 Exp 2	"Exp" refer to Expansion, these two buttons are reserved functions and pending future development.

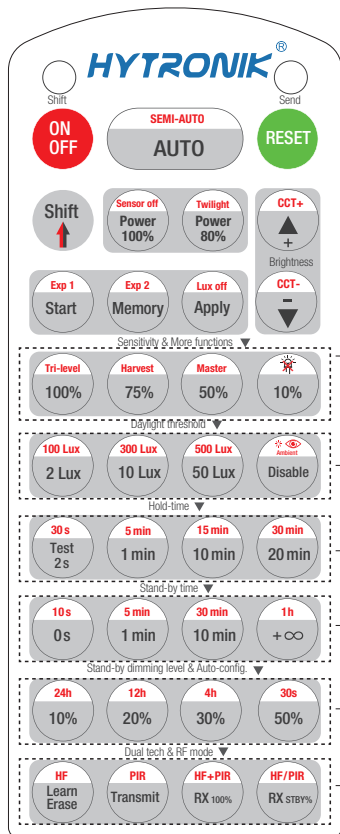

HRC-11

Sensitivity & More functions	
100% 75% 50% 10%	In AUTO /SEMI-AUTO modes, press buttons in zone "Detection range" to set detection range at 100%/75%/50%/10%.
<b>Tri-level Harvest</b>	This key is not applicable on this product.
<b>Master</b>	This key is not applicable on this product.
Daylight threshold	
2 Lux 100 Lux 10 Lux 300 Lux 50 Lux 500 Lux Disable	Press buttons in zone "Daylight threshold" to set daylight sensor at 2Lux / 10Lux / 50Lux / 100Lux / 300Lux/500Lux / Disable. <i>Note: To set daylight sensor at 100Lux / 300Lux/500Lux, press "Shift" button first.</i>
	1. Press button "Shift", the red LED on. 2. Press button "Ambient", the surrounding lux level is sampled and set as daylight threshold.
Hold-time mode	
Test 30 s 2 s 1 min 5 min 10 min 15 min 20 min 30 min	In AUTO /SEMI-AUTO modes, press buttons in zone "hold-time" to set the hold-time at 2s / 30s / 1min / 5min / 10min / 15min / 20min / 30min. <i>Note: 1. To set hold-time at 30s / 5min / 15min / 30min, press "Shift" button first. 2. 2s is for testing purpose only, stand-by period and daylight sensor settings are disabled in this mode. *To exit from Test mode, press button "RESET" or any button in "Hold-time".</i>
Stand-by time mode	
0s 10s 1 min 5 min 10 min 30 min +∞ 1h	Press buttons in zone "stand-by time" to set the stand-by period at 0s / 10s / 1min / 5min / 10min / 30min / 1h / +∞. <i>Note: 1. To set stand-by-time at 10s / 5min / 30min / 1h, press "Shift" button first. 2. "0s" means on/off control; 3. "+∞" means bi-level control, the fixture is 100% on when there is motion detected, and remains at the stand-by dimming level when no presence after motion hold-time. Only when the stand-by time is set in "+∞" and the ambient lux level is below the target lux level, the lux will auto-on.</i>
Stand-by dimming level & Auto-config.	
10% 20% 30% 50%	Press the button in zone "stand-by dimming level" to set the stand-by dimming level at 10% / 20% / 30% / 50%.
<b>24h</b> <b>12h</b> <b>4h</b> <b>30s</b>	1.Press button "Shift", the red LED on. 2.Select a time period and the sensor will do light level measurement and determine/save the lowest light level (commission line) with 100% light on, so as to set the target lux level automatically. <i>Note:1.Make sure the light level measurement covers the night time. 2.The fixture will go into sensor mode after the measurement, all sensor setting remain unchanged.</i>
Dual tech & RF mode	
Learn Erase Transmit	This key is not applicable on this product.
RX 100% RX STBY%	This key is not applicable on this product.
<b>HF</b> <b>PIR</b> <b>HF+PIR</b> <b>HF/PIR</b>	This key is not applicable on this product.