

New advanced⁺ version condominating control

Model: HC019V

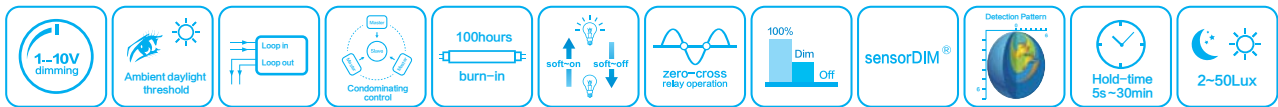
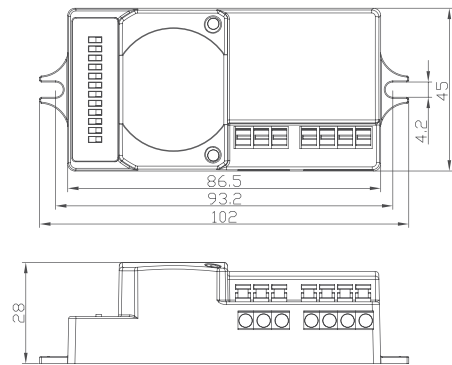
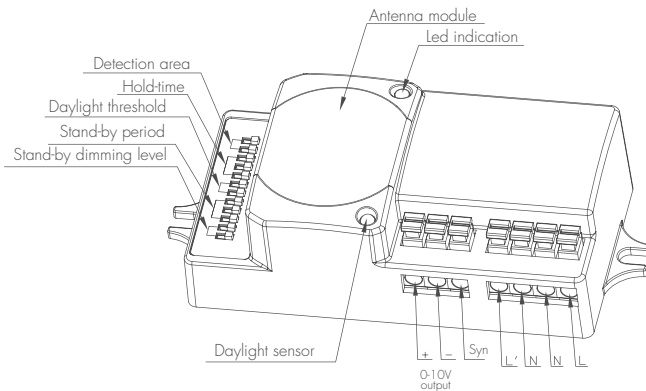

In many cases, several sensors are connected together to control the same fixture, or to trigger on each other, the sudden on/off of the lamp tube causes huge magnetic pulse, which may mis-trigger the sensor. Hytronik condominium sensor HC019V employed a strong software to overcome that magnetic interference and is specially designed for that application with 1-10V dimming control.

Function and options

In a lot of buildings there is a need that you have a function in corridors and undercover garages that you can trigger a master luminary with connected slave luminaries from more than one direction. Each and one of the Master luminaries (containing the sensor) should be able to trigger the whole installation whether it's an on/off or dimming installation.

See the below example that there are several exits/entrances to the corridor, any sensor at any exit/entrance is triggered, the luminaries in the group light up.

1 3 Steps Dimming Control (Corridor Function)

Same as Tridonic excel ballast, Hytronik builds this function inside the motion sensor to achieve 3 steps dimming control, for some areas that require a light change notice before switch-off.

It offers 3 levels of light : 100%-->dimmed light (10%, 20%,30%,40%, 50% optional)-->off; and 2 periods of selectable waiting time: motion holdtime and standby period ; selectable daylight threshold and freedom of detection area.

With sufficient natural light, the light does not switch on when presence detected

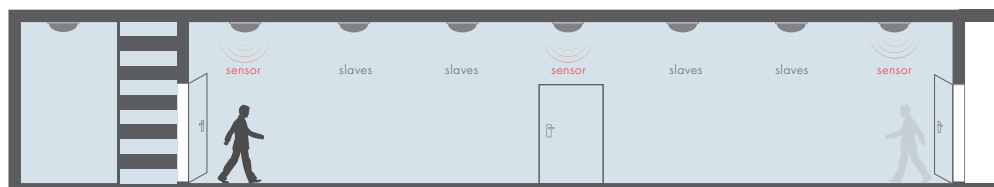

With insufficient nature light, the person comes from any direction, the group of lamps switch on.

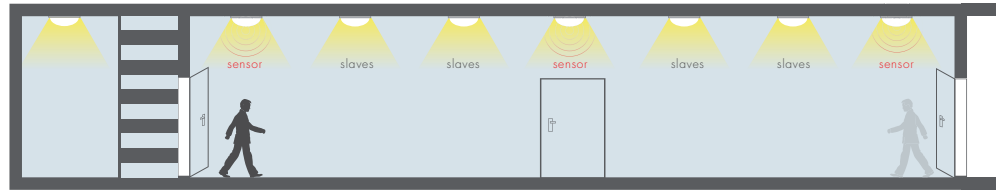

After the hold time, the whole group of lamps dims to pre-defined dimming level when no movement detected.

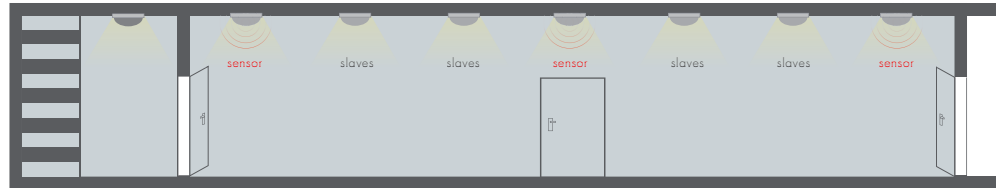

After the stand-by period, the whole group of lamps switches off automatically.

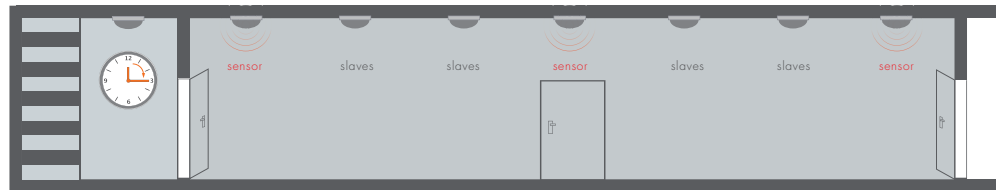

2 100H burn-in mode for fluorescent lamp

With simple operation, rapidly turn off/on the fixture 3 cycles within 3 sec. (the green LED on the sensor flashes and the fixture blinks 3 times to indicate the success of setup), lamp will be 100% on for 100 hours, and then automatically goes to sensor mode after 100 hours. This is crucial to secure the lifetime of fluorescent lamp, when new fixture is installed, or old lamp is replaced.

This 100h burn-in feature can be cancelled by turning off/on the fixture 1 cycle within 1sec.

3 ambient daylight threshold

With simple operation, rapidly turn off/on the fixture 2 cycles within 2 sec:

1. the green LED on the sensor flashes slowly for 5 seconds, meanwhile the fixture blinks twice.
2. the daylight sensor measures and remembers the surrounding lux for 1 sec.
3. the fixture and green LED is on for 10s to indicate the success of learning.

* This feature enables the fixture to function well in any real application circumstance, where the daylight penetrated into fixture may vary a lot.

* The latest surrounding lux value overwrites previous lux value learned.

* Both the setting on DIP switch and the learned ambient lux threshold can overwrite each other. The latest action stays in validity.

4 zero-cross relay operation

designed in the software, the sensor switches on/off the load right on the zero-cross point, to ensure the min. current passing through the relay contact point, and enable the maxi. load and life-time of the relay.

5 loop-in and loop-out

double L N terminal makes it easy for wire loop-in and loop-out, saves the cost of terminal block and assembly time.

oops: 1. motion sensor overwrites daylight sensor, meaning the daylight sensor starts to check the ambient natural light only when the lamp is switch off (motion hold-time elapsed).

2. this 1-10v output is isolated, SELV output.

6 wiring diagram

1 sensor controls a group of ballast /driver-

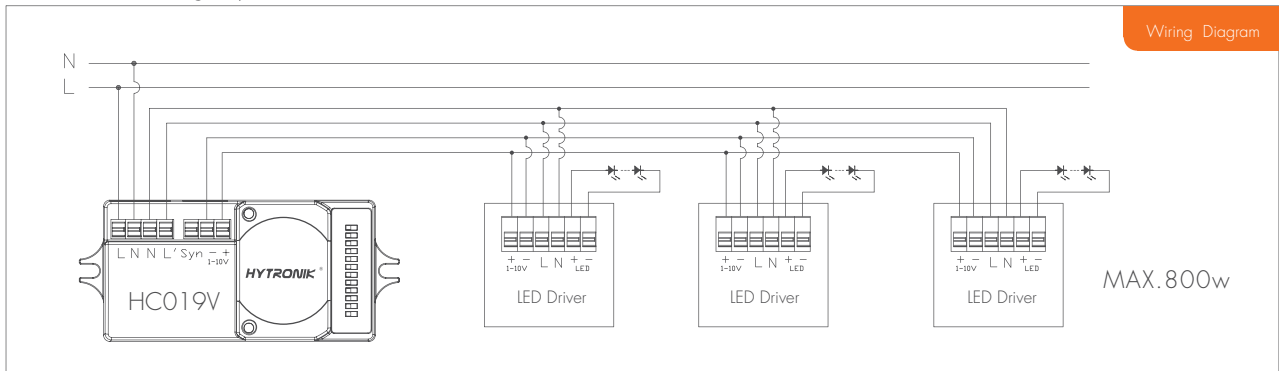

Multiple sensors control the same group of ballast /driver-

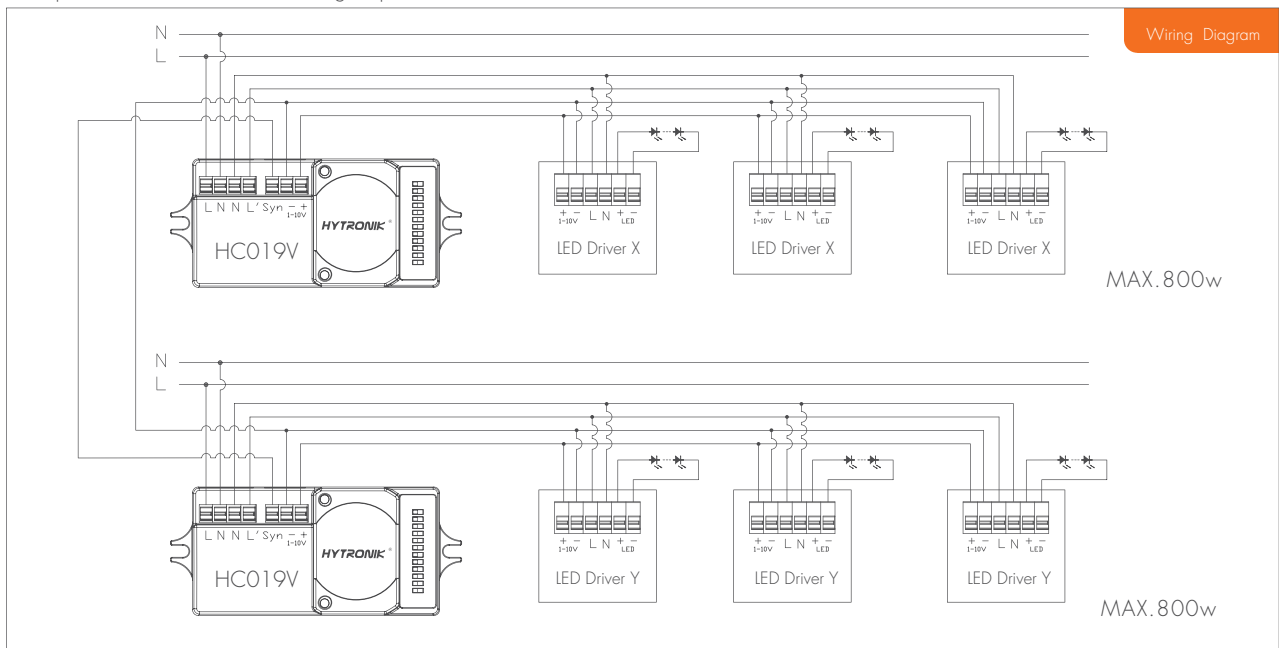

Oops: do not connect the 1-10v terminals on driver X to Driver Y.

Detection Pattern

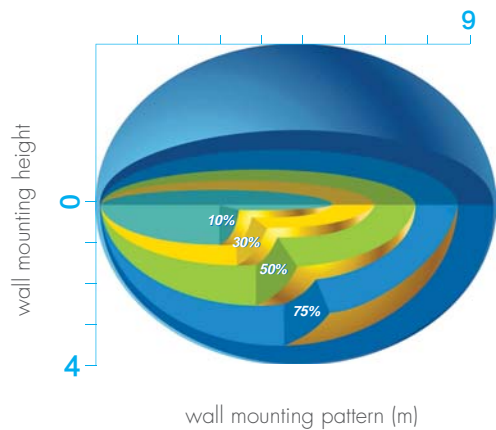
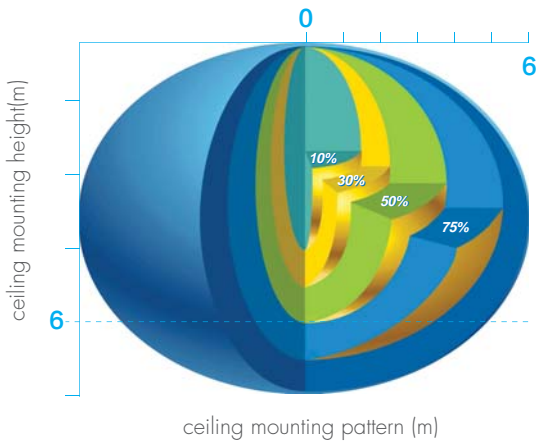

Settings

1 Detection area

Detection area can be reduced by selecting the combination on the DIP switches to fit precisely for each specific application.

	1	2	
I	●	●	100%
II	●	○	75%
III	○	●	50%
IV	○	○	10%

I – 100%
II – 75%
III – 50%
IV – 10%

2 Hold-time

Hold-time means the time period you would like to keep the lamp on 100% after the person has left the detection area.

	1	2	3	
I	●	●	●	5s
II	●	●	○	30s
III	●	○	●	1min
IV	●	○	○	5min
V	○	●	●	10min
VI	○	●	○	20min
VII	○	○	○	30min

I – 5S
II – 30S
III – 1min
IV – 5min
V – 10min
VI – 20min
VII – 30min

3 Daylight sensor

The daylight threshold can be set on DIP switches, to fit for particular application.

	1	2	
I	●	●	Disable
II	●	○	50Lux
III	○	●	10Lux
IV	○	○	2Lux

I – Disable
II – 50Lux
III – 10Lux
IV – 2Lux

4 Stand-by period(corridor function)

This is the time period you would like to keep at the low light output level before it is completely switched off in the long absence of people.

note: "0s" means on/off control;

"+ ∞" means 2 steps of dimming control, fixture never switch off.

	1	2	3	
I	●	●	●	0s
II	●	●	○	10s
III	●	○	●	1min
IV	●	○	○	5min
V	○	●	●	10min
VI	○	●	○	30min
VII	○	○	●	1h
VIII	○	○	○	+∞

I – 0s
II – 10s
III – 1min
IV – 5min
V – 10min
VI – 30min
VII – 1h
VIII – +∞

5 Stand-by dimming level

This is the dimmed low light output level you would like to have after the hold-time in the absence of people.

	1	2	
I	●	●	10%
II	●	○	20%
III	○	●	30%
IV	○	○	50%

I – 10%
II – 20%
III – 30%
IV – 50%

Technical Data

Operating voltage	220-240V
Switched power	Max.800W (capacitive)
Standby power	<1w
Warm time	20s
Detection area	10/50/75/100%, can be customized
Hold time	5S/30S/1min/5min/10min/20min/30min, can be customized
Standby period	0s/10s/1min/5min/10min/30min/1h/+∞ can be customized
Standby dimming level	10%/20%/30%/50% can be customized
Daylight threshold	2~50lux daylight/twilight/darkness, can be customized
Sensor principle	Microwave motion detector
Microwave frequency	5.8GHz+/-75MHz
Microwave power	<0.2mw
Detection range	Max. (∅xH): 12m x 6m
Detection angle	30°~150°
Mounting height	Max.6m
Operating temperature	-35°C ~ +70°C
IP rating	IP20 IP65(mounting in Hytronik special box)
Certificate	Semko, EMC, CE, R&TTE