

True Occupancy Sensor with

Bluetooth® 5.0 SIG Mesh



HYTRONIK®



HBMW29/PRO

DALI-2 output & Low-bay

Product Description

HBMW29/PRO is a DALI/DALI-2 Bluetooth Microwave standalone motion sensor which integrated with Hytronik True occupancy detection technology. The Hytronik True occupancy detection technology works to detect human breathing rather than the mirror movements. No matter if the person sit/stand statically or turns their back to the sensor. The sensor accurately recognizes occupancy and keeps the lights on continuously, making it highly suitable for stable and peaceful environments such as offices and hotels, though not recommended for industrial settings. With Bluetooth wireless mesh networking, it makes communication between luminaires much easier without time-consuming hardwiring, which eventually saves costs for projects (especially for retrofit upgrade projects!). Meanwhile, simple device setup and commissioning can be done via **Koolmesh®** app.



App Features

- Adjustable motion & static sensitivity & Adjustable sensing distance
- Quick setup mode & advanced setup mode
- Tri-level control
- Daylight harvest
- Floorplan feature to simplify project planning
- Web app/platform for dedicated project management
- Koolmesh Pro iPad version for on-site configuration
- Grouping luminaires via mesh network
- Scenes
- Detailed motion sensor settings
- Dusk/Dawn photocell (Twilight function)
- Push switch configuration
- Schedule to run scenes based on time and date
- Astro timer (sunrise and sunset)
- Staircase function (primary & secondary)
- Internet-of-Things (IoT) featured
- Device firmware update over-the-air (OTA)
- Device social relations check
- Bulk commissioning (copy and paste settings)
- Dynamic daylight harvest auto-adaptation

- Power-on status (memory against power loss)
- Offline commissioning
- Different permission levels via authority management
- Network sharing via QR code or keycode
- Remote control via gateway support HBGW01
- Interoperability with Hytronik Bluetooth product portfolio
- Compatible with EnOcean BLE switches
- Continuous development in progress...

Hardware Features

- 50mA DALI broadcast output
- Support to control DT8 LED drivers
- Black & White & Gray metal surface mount box options
- User-friendly design for installation
- 5 Year warranty

Bluetooth® Kinetic Switch

HBKS01 HBKS02 HBKS03 HBKS01D HBKS02D

Fully support EnOcean self-powered switch module
PTM215B (HBES01/W & HBES01/B)

EnOcean
Self-powered IoT

Bluetooth® 5.0 SIG mesh

Smartphone app for both iOS & Android platform

Koolmesh Pro app for iPad

Web app/platform: www.iot.koolmesh.com

Technical Specifications

Bluetooth Transceiver	
Operation frequency	2.4 GHz - 2.483 GHz
Transmission power	4 dBm
Range (Typical indoor)	10~30m
Protocol	 Bluetooth® 5.0 SIG Mesh

Sensor Data	
Sensor Model	Occupancy Motion detection
Ceiling-mounted Detection range (Max.)*	Installation Height : 3m Diameter(Ø) : 8m
Wall-mounted Detection range (Max.)*	Installation Height : 3m Detection Range : 6m
Detection angle	360°

*For more details of detection range, please refer to "detection pattern" section.

Safety and EMC	
EMC standard (EMC)	EN55015, EN61000-3-2/-3-3, EN61547
Safety standard (LVD)	EN60669-1, EN60669-2-1
RED	EN300440, EN300328, EN301489-1/-3/-17, EN50663
Certification	CE, RCM, UKCA

Input & Output Characteristics	
Operating voltage	220~240VAC 50/60Hz
Stand-by power	<1W
Output	I guaranteed : 30mA I max : 50mA U rated : 15VDC
Warming-up	20s

Environment	
Operation temperature	Ta: -25°C ~ +60°C
Storage temperature	-40°C ~ +70°C
IP rating	IP20/IP54
Relative humidity	20 ~ 90%

Mechanical Structure

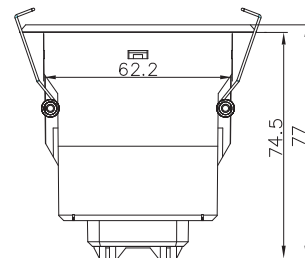
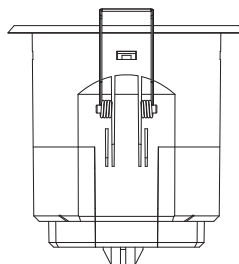
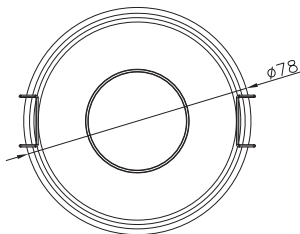
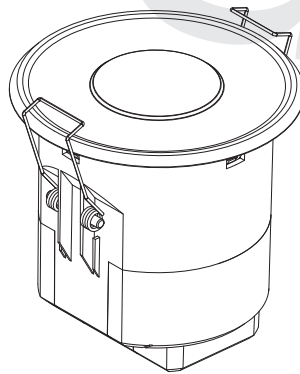

Wire Preparation

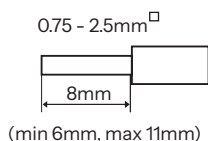
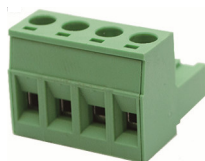

Pluggable screw terminal. It is recommended to make connections to the terminal before fitting to the sensor.

1. 200 metres (total) max. for 1mm² CSA (Ta = 50°C)
2. 300 metres (total) max. for 1.5mm² CSA (Ta = 50°C)

Wiring Diagram

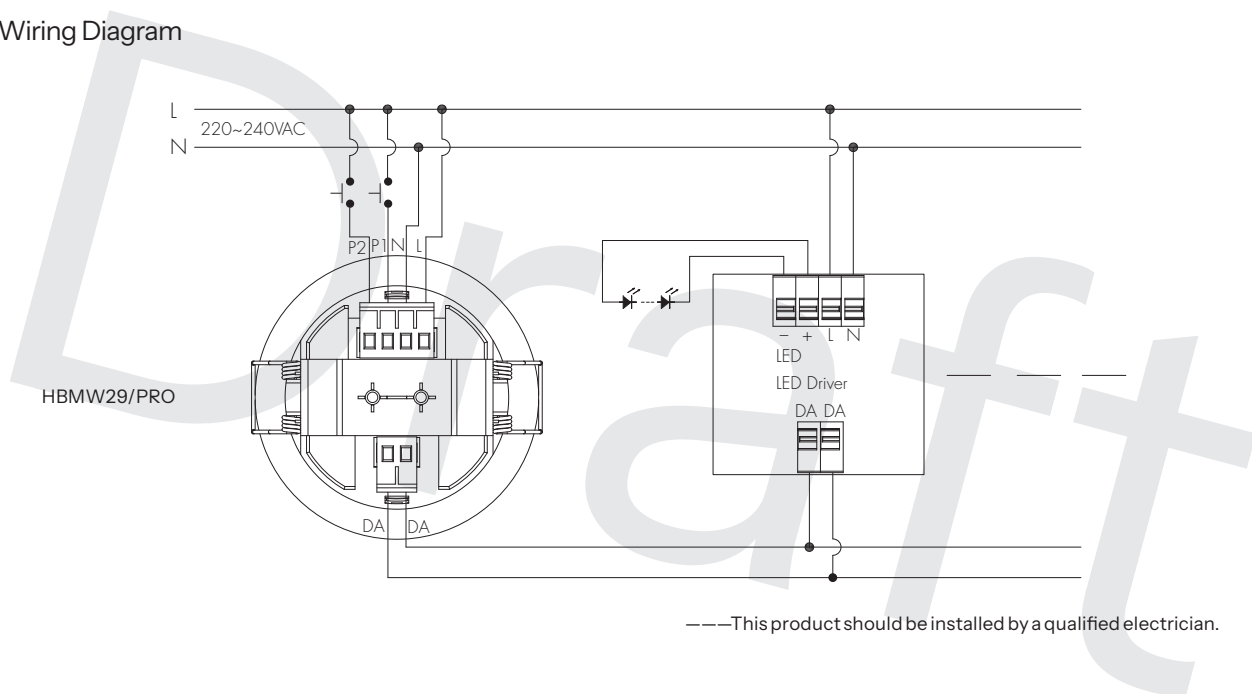

Sensor Installation and Commissioning Guidelines

A. Installation Preparation

1. Make sure the room is empty with no moving people or machinery when first powered up for 1 minute.
2. There is a 20-second warm-up time for the sensor. Please do the commissioning after warm-up.
3. When the sensor is powered off, repeat the initial steps once it's re-powered

B. Sensor Placement

1. The distance between sensors should be at least 3 meters.
2. Sensors should not directly face sources of microwave interference, such as other microwave sensors, microwave ovens, or wireless routers. Maintain a distance of at least 3 meters.
3. The installation environment should avoid object vibrations, strong airflows, curtain movements, water flow in pipes, window glass vibrations, and wind-induced movements of metal roofs. Aim for a stable environment with minimal variables.
4. The sensor is highly sensitive and suitable for stable and quiet environments like offices and hotels, but not for industrial settings.

C. Sensor Operation

1. Movements within 0.3 meters of the sensor, such as waving an arm, might not trigger the sensor, as it will identify and filter out such large movements.
2. In test mode, a red LED will flash when the sensor is triggered. There are no visual indications in normal mode.
3. If the sensor is too sensitive, use the HRC-12 remote controller to lower the sensitivity.
4. Avoid accidentally entering semi-auto mode.
5. Pay attention to the daylight sensor threshold value, which needs to be adjusted according to the installation environment.

Placement Guide and Typical Range

Smart Phone to Device Range

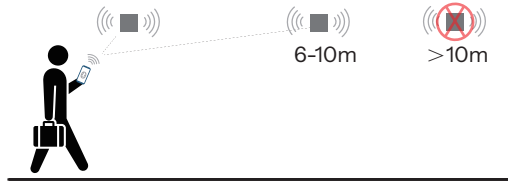

The smart device with the App installed will have a typical range of 10m, but varies from device to device. During commissioning, the installer will need to be in range of the devices when searching for devices to add to the network.

Once the devices have been added to the network via the App, the devices will start communicating within the wireless mesh. This means that once the network is complete, all devices are accessible from the smart device when in a 20m range of a single point.

Detection Pattern

Ceiling-mounted application Installation height: 3m

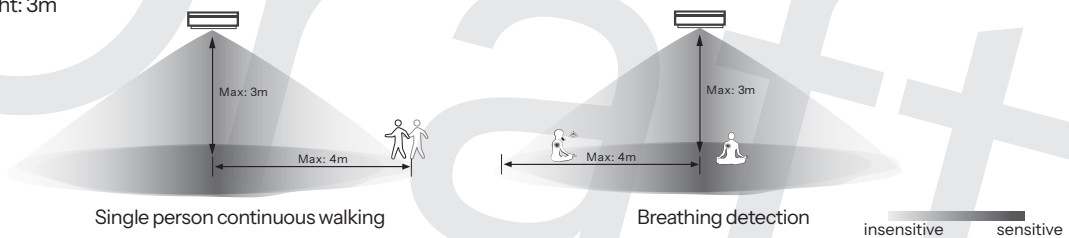

*When it's in breathing & true occupancy detection mode and in sitting situation, facing to sensor directly will have a better detection range than 90 degrees side facing to sensor.

Wall-mounted application Installation height: max.3m

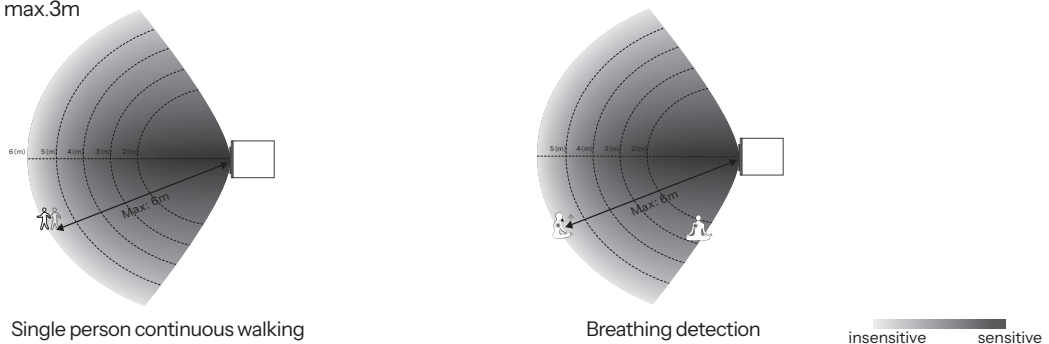

*When it's in breathing & true occupancy detection mode and in sitting situation, facing to sensor directly will have a better detection range than 90 degrees side facing to sensor.

Optional Accessory --- Ceiling/Surface Metal Mount Box: HA09/W, HA09/B, HA09/G

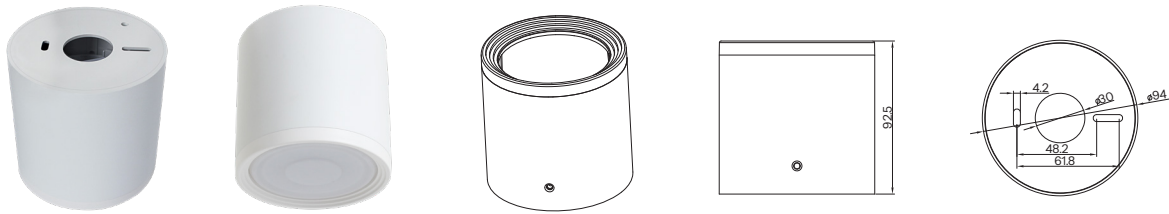

Optional Accessory --- HA08

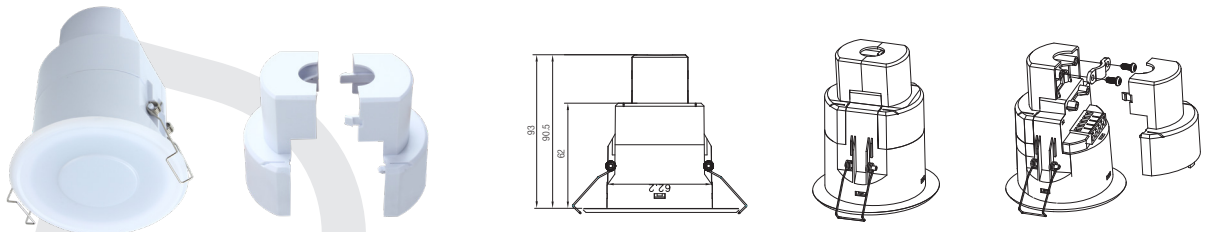

*Note: Optional Accessory HA09 & HA08 can not be used together.

Big and small silicon gasket used to make IP54 degree protection (mounted into HA09 housing for ceiling mount)

Small silicon water-proof gasket dimension(size:mm)

Big silicon water-proof gasket dimension(size:mm)

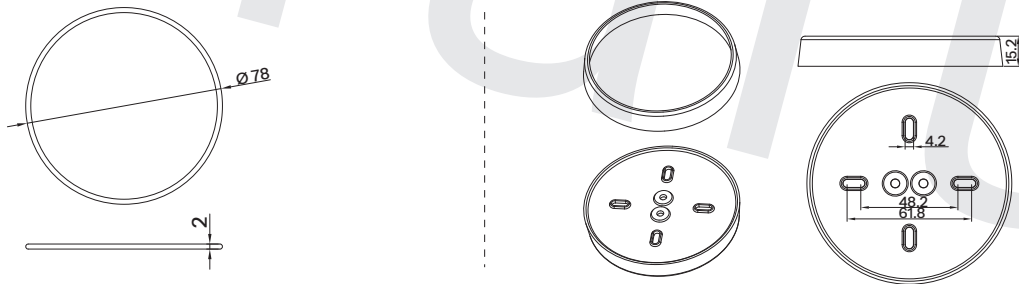

Additional Information / Documents

1. To learn more about detailed product features/functions, please refer to www.hytronik.com/download →knowledge →Introduction of App Scenes and Product Functions
2. Regarding precautions for Bluetooth product installation and operation, please kindly refer to www.hytronik.com/download →knowledge →Bluetooth Products - Precautions for Product Installation and Operation
3. Data sheet is subject to change without notice. Please always refer to the most recent release on www.hytronik.com/products/bluetooth-technology →Bluetooth Sensors
4. Regarding precautions for HF sensor installation and operation, please kindly refer to www.hytronik.com/download →knowledge →Microwave Sensors - Precautions for Product Installation and Operation
5. Regarding Hytronik standard guarantee policy, please refer to www.hytronik.com/download →knowledge →Hytronik Standard Guarantee Policy