

HED1025

Constant Current





























Product Description

HED1025 is a driver with a maximum output range of 25W that can be adjusted via switch-dim, 1-10V, and DALI, or controlled by one of four different types of Bluetooth antenna options. By simply connecting Bluetooth sensor head HBTO1/HBTO2/HIR13/HIR16/HIR62/HIR62/R to the driver, it allows for motion detection and Bluetooth mesh control. Once the sensor head is connected to the driver, DALI & 1-10V control are then disabled and sensor antenna will take control. With Bluetooth wireless mesh networking, it makes communication between luminaires much easier without time-consuming hardwiring, which eventually saves costs for projects. Meanwhile, simple device setup and commissioning can be done via **Koolmesh**® app.













HYTRONIK®



App Features

-  Quick setup mode & advanced setup mode
-  Tri-level control
-  Daylight harvest
-  Circadian rhythm (Human centric lighting)
-  Floorplan feature to simplify project planning
-  Web app/platform for dedicated project management
-  Koolmesh Pro iPad version for on-site configuration
-  Grouping luminaires via mesh network
-  Scenes
-  Detailed motion sensor settings
-  Dusk/Dawn photocell (Twilight function)
-  Push switch configuration
-  Schedule to run scenes based on time and date
-  Astro timer (sunrise and sunset)
-  Staircase function (primary & secondary)
-  Internet-of-Things (IoT) featured
-  Device firmware update over-the-air (OTA)
-  Device social relations check
-  Bulk commissioning (copy and paste settings)
-  Dynamic daylight harvest auto-adaptation
-  Power-on status (memory against power loss)
-  Offline commissioning
-  Different permission levels via authority management
-  Network sharing via QR code or keycode
-  Remote control via gateway support HBGW01
-  Interoperability with Hytronik Bluetooth product portfolio
-  Compatible with EnOcean BLE switches
-  Continuous development in progress...

Hardware Features

-  Switch-Dim
-  1-10V
-  With DALI feedback
-  4 types of optional sensor heads available
-  Plug'n'Play for flexible installation and cost saving assemble
-  Photocell Advance™
-  Insulated terminal cover with cord restraint
-  Stand by power <0.5W
-  Active PFC design
-  Analogue flicker-free dimming
-  Logarithmic dimming with multiple dimming inputs
-  Configurable constant power (CC) output via DIP switch
-  Open-circuit Protection
-  Over-temperature Protection
-  Short-circuit Protection
-  Overload Protection
-  5-year warranty

Current Output Configuration

HED1025, 1x25W

700mA	●●●●
675mA	○●●●
650mA	●○●●
625mA	○●○●
600mA	●●○●
575mA	○●●○
550mA	●●●○
525mA	○●○●
500mA	●●○●
475mA	○●●○
450mA	●●○●
425mA	○●○●
400mA	●●○●
375mA	○●●○
350mA	●●○●
325mA	○●○●
	1 2 3 4

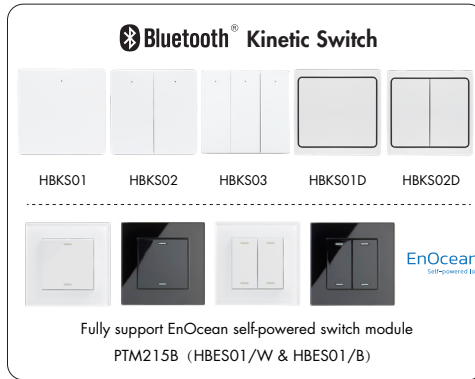

Bluetooth 5.0 SIG mesh

HYTRONIK Koolmesh iOS Android

Smartphone app for both iOS & Android platform

Koolmesh Pro app for iPad

Web app/platform: www.iot.koolmesh.com

Technical Specifications

Model No.		HED1025
Input	Mains Voltage	220~240VAC 50/60Hz
	Mains Current	0.15~0.13A
	Power Factor	0.9
	Max. Efficiency	88%
	Dielectric Strength	Input→Output : 3000VAC
	Leakage Current	< 0.25mA
Output	Ripple Current	<3%
	Uout Max.	90V
	Turn-on Time	< 0.5s
	Dimming Interface	DALI, Switch-Dim
Environment	Operation Temp.	Ta: -20~+50℃
	Case Temp. (Max.)	80℃
	IP Rating	IP20
Safety and EMC	EMC Standard	EN55015, EN61547, EN61000-3-2, EN61000-3-3
	Safety Standard	EN61347-1, EN62493, EN61347-2-13
	DALI Standard	IEC62386-101 ; IEC62386-102 ; IEC62386-207
	Certifications	CB, RCM, CE , EMC

Model No.	Max. output power/current/voltage range			
HED1025	19.5W/ 325mA /12~60V	21W/ 350mA /12~60V	22.5W/ 375mA /12~60V	24W/ 400mA /12~60V
	25.5W/ 425mA /12~60V	27W/ 450mA /12~60V	26W/ 475mA /12~55V	27.5W/ 500mA /12~55V
	26W/ 525mA /12~50V	27.5W/ 550mA /12~50V	26W/ 575mA /12~45V	27W/ 600mA /12~45V
	28W/ 625mA /12~45V	28W/ 650mA /12~43V	27W/ 675mA /12~40V	28W/ 700mA /12~40V

Mechanical Structure & Dimensions (unit:mm)

Model: HED1025 1x25W

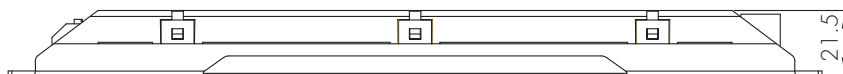
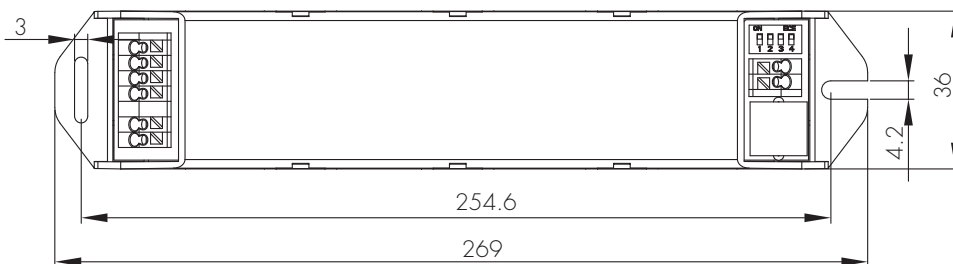
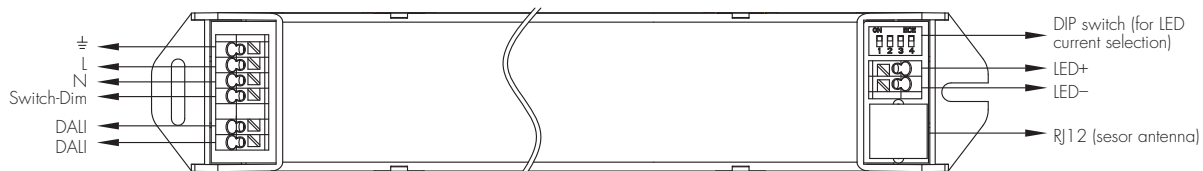

Wiring Diagram

Note: If connecting an antenna, the DALI inputs are disabled.

Switch-Dim Connections

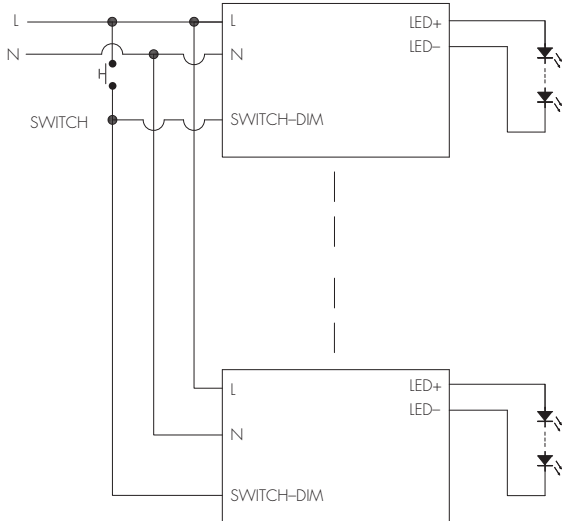

1-10V Connections

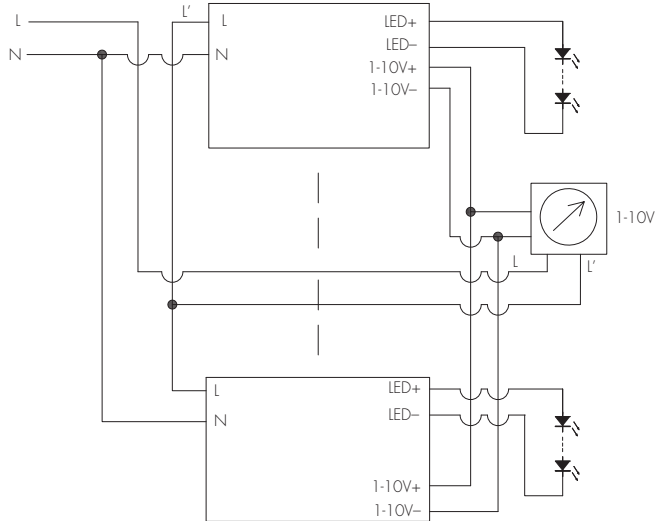

DALI Connections

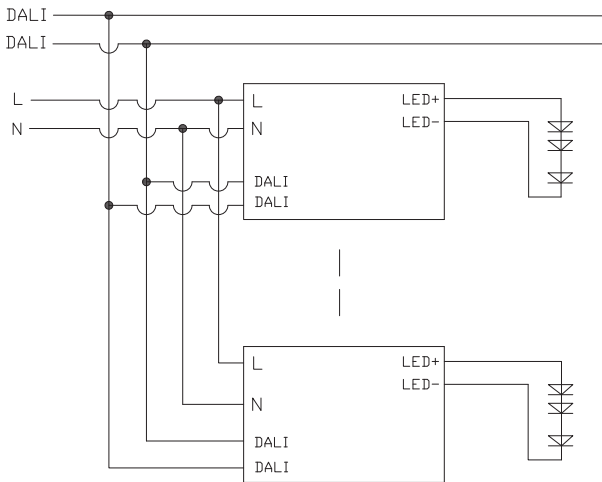

Antenna Connections (with optional Switch-Dim)

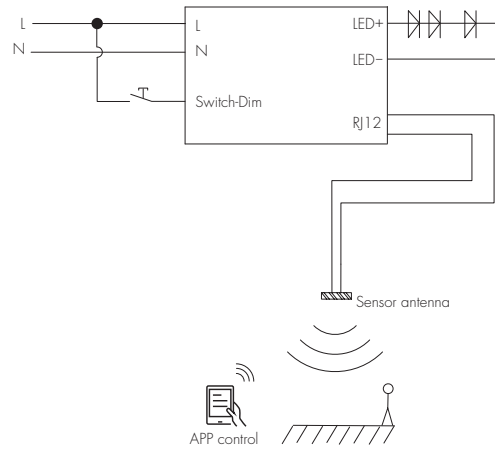

Note: 1. Unused terminals have been omitted for clarity.
 2. If connecting an antenna, the DALI and 1-10V inputs are disabled.

Wire Preparation

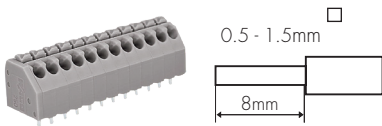

To make or release the wire from the terminal, use a screwdriver to push down the button.

Loading and In-rush Current

Model	HED1025
In-rush Current (I _{max.})	40A
Pulse Time	98.4 μs

Circuit Breaker Information

Automatic circuit breaker type	B16A	B10A	B13A	B20A	B25A
HED1025	72	45	59	90	113

The data above is calculated according to the formula: $\text{Maximum Amount} = 16 / (P_n / 230)$. In order to provide a more reliable reference in real application, the data have been revised to take 60% of the number calculated, i.e. $16 / (P_n / 230) \times 60\%$. Please kindly take note that the calculation is based on ABB circuit breaker series S200. Actual values may differ due to different types of circuit breaker used and installation environment.

Performance Characteristics

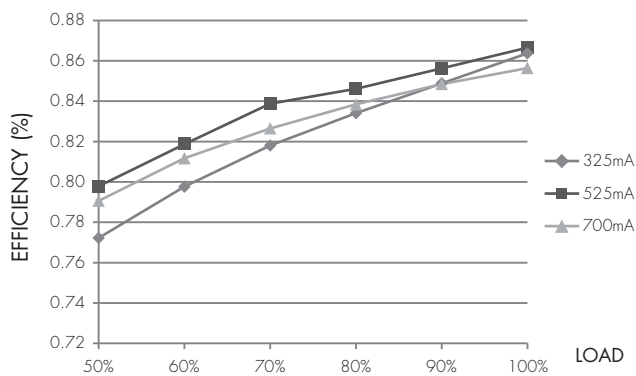

* Typical Efficiency vs Load

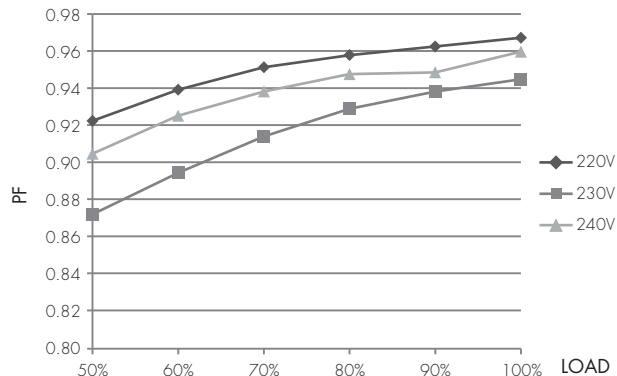

* Typical Power Factor vs Load

Dimming Profile

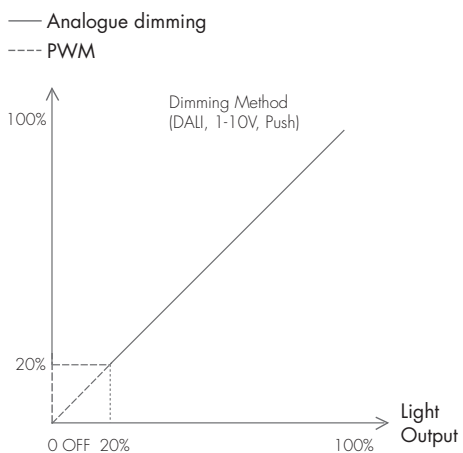

Dimming range	Dimming technique
20%-100%	Analogue
1%-20%	PWM

Technical Specifications for Sensor Heads

Bluetooth Transceiver	
Operation frequency	2.4 GHz - 2.483 GHz
Transmission power	4 dBm
Range (Typical indoor)	10~30m
Protocol	Bluetooth® 5.0 SIG Mesh

Environment	
Operation temperature	Ta: -20°C ~ +55°C
Storage temperature	-20°C ~ +70°C
Relative humidity	0 ~ 90%
IP rating	IP20

HF Sensor Properties (HBT01)	
Sensor principle	High Frequency (microwave)
Operation frequency	5.8GHz +/- 75MHz
Transmission power	<0.2mW
Detection range *	Max installation height: 3m Max detection range (Ø): 8m
Detection angle	30° ~ 150°

PIR Sensor Properties (HIR13 & HIR16 & HIR62 & HIR62/R)		
Sensor principle	PIR detection	
Operation voltage	5VDC	
Detection range *	HIR13 Max installation height: 15m (forklift) 12m (single person) Max detection range (Ø): 24m	
	HIR16 Max installation height: 15m (forklift) 12m (single person) Max detection range: 18m * 6m (L * W)	
	HIR62 Max installation height: 3m (single person) Max detection range (Ø): 12m	
	HIR62/R Max installation height: 8m (single person) Max installation height: 12m (forklift) Max detection range (Ø): 14m	
	Detection angle	360°

* The detection range is heavily influenced by sensor placement (angle) and different walking paces. It may be reduced under certain conditions.

PIR & microwave sensor heads

The range of PIR and microwave sensor heads below with Bluetooth modules built in offers powerful number of Plug'n'Play feature options to expand the flexibility of luminaires design. This approach to luminaire design reduces space requirements and component costs whilst simplifying production.

A. HBT01

Surface mounting
Photocell Advance™
The cable length is around 30cm.

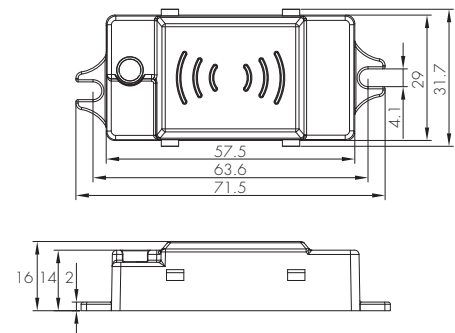
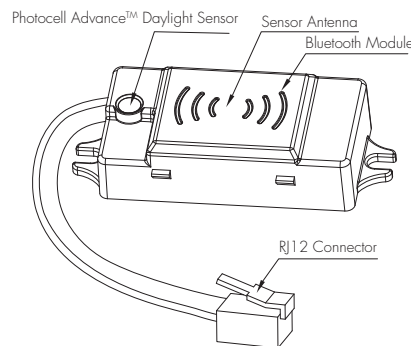

B. HBT02

Surface mounting
Without motion sensor
Photocell Advance™
The cable length is around 30cm.

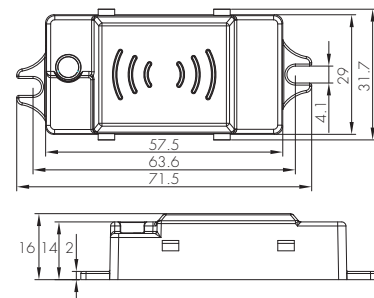
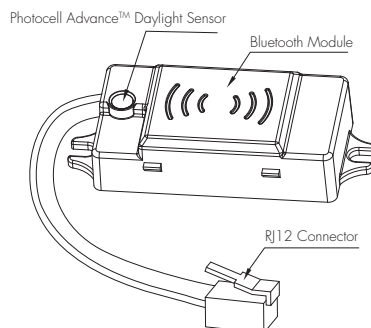

C. HIR13/S

Surface mounting
 For highbay application
 IP65 (facia / lens part)
 The cable length is around 30cm.

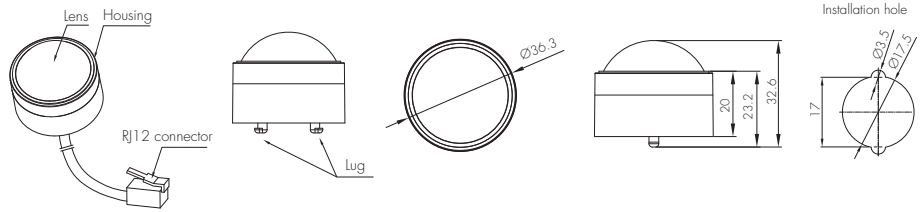

D. HIR13/F

Flush mounting
 For highbay application
 IP65 (facia / lens part)
 The cable length is around 30cm.

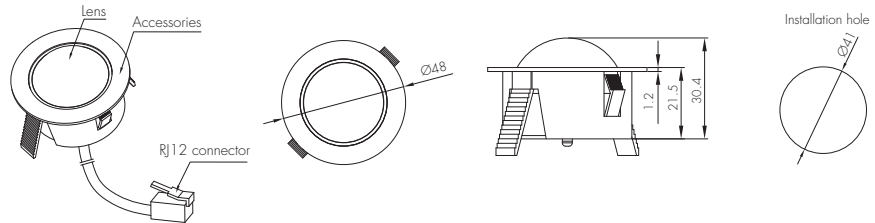

E. HIR13/C

Screw to the luminaire by conduit
 For highbay application
 IP65 (facia / lens part)
 The cable length is around 30cm.

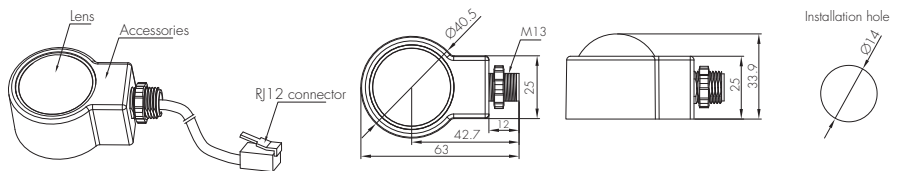

F. HIR16

PIR sensor head
 For highbay application
 IP65 (facia / lens part)
 The cable length is around 30cm.

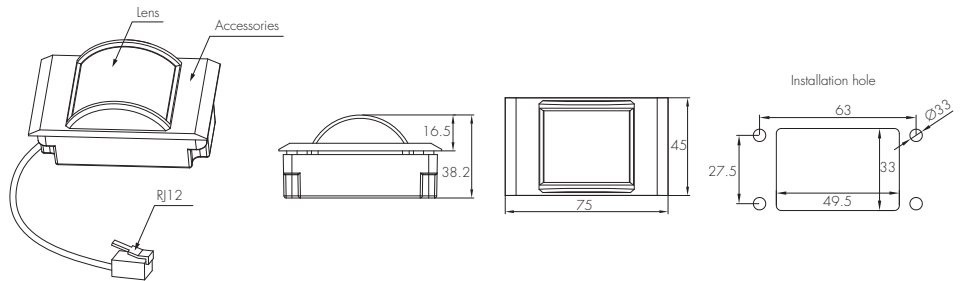

Installation for HIR16

Thickness: 0.8mm – 1.6mm

We suggest that the metal plate thickness to be 0.8mm – 1.6mm to ensure perfect focal length for the PIR lens.

G. HIR62

Zhaga connection
The cable length is around 35cm.

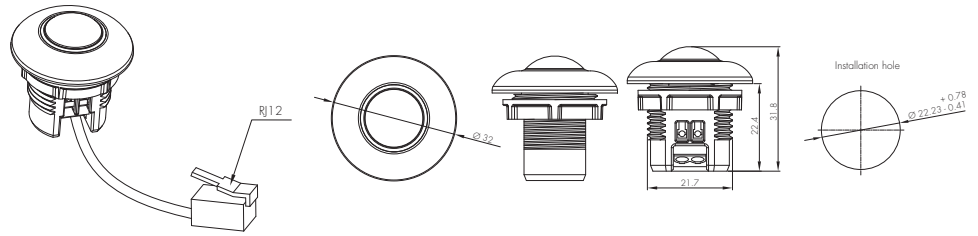

H. HIR62 with HA04

Zhaga connection
Optional accessory
The cable length is around 35cm.

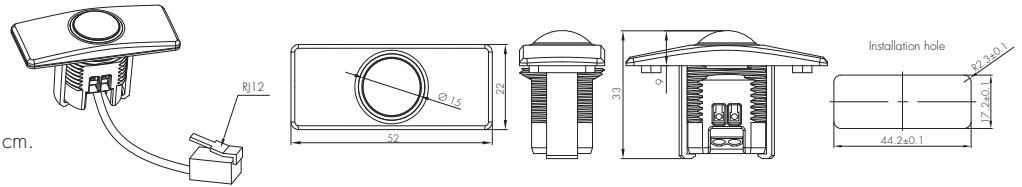

I. HIR62 with HA05

Zhaga connection
Optional accessory
The cable length is around 35cm.

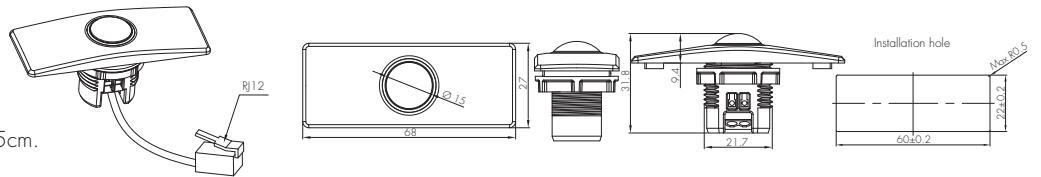

J. HIR62/R

Zhaga connection
The cable length is around 35cm.

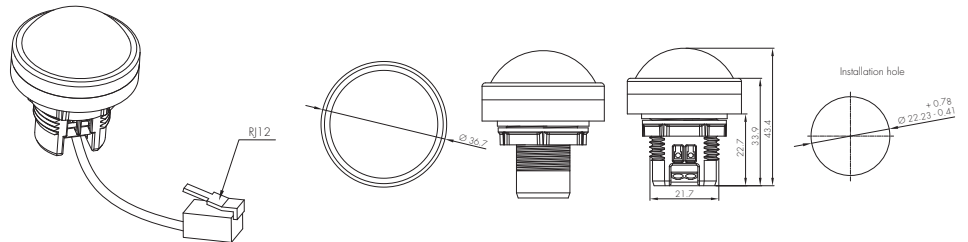

Detection Pattern

HBT01

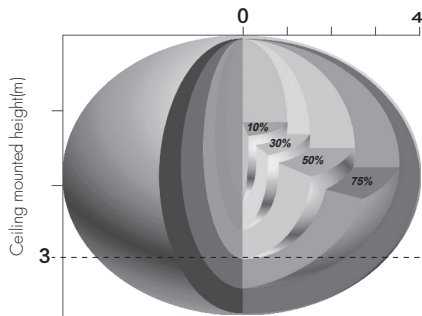

The detection range is heavily influenced by sensor placement (angle) and different walking paces.

It may be reduced to 2m(diameter) & 3m(height) under certain conditions (walking across).

HIR13 (High-bay)



HIR13: High-bay lens detection pattern for forklift @ Ta = 20°C
(Recommended installation height 10m-15m)

Mount height	Tangential (A)	Radial (B)
10m	max 380m ² (Ø = 22m)	max 201m ² (Ø = 16m)
11m	max 452m ² (Ø = 24m)	max 201m ² (Ø = 16m)
12m	max 452m ² (Ø = 24m)	max 201m ² (Ø = 16m)
13m	max 452m ² (Ø = 24m)	max 177m ² (Ø = 15m)
14m	max 452m ² (Ø = 24m)	max 133m ² (Ø = 13m)
15m	max 452m ² (Ø = 24m)	max 113m ² (Ø = 12m)



HIR13: High-bay lens detection pattern for single person @ Ta = 20°C
(Recommended installation height 2.5m-12m)

Mount height	Tangential (A)	Radial (B)
2.5m	max 50m ² (Ø = 8m)	max 7m ² (Ø = 3m)
6m	max 104m ² (Ø = 11.5m)	max 7m ² (Ø = 3m)
8m	max 154m ² (Ø = 14m)	max 7m ² (Ø = 3m)
10m	max 227m ² (Ø = 17m)	max 7m ² (Ø = 3m)
11m	max 269m ² (Ø = 18.5m)	max 7m ² (Ø = 3m)
12m	max 314m ² (Ø = 20m)	max 7m ² (Ø = 3m)

HIR16

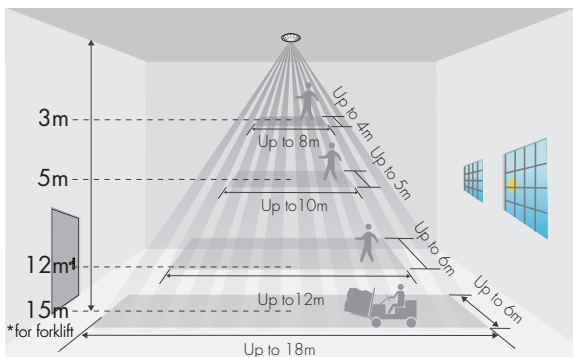

*The detection patterns are based upon 5km/h movement speed.

HIR62

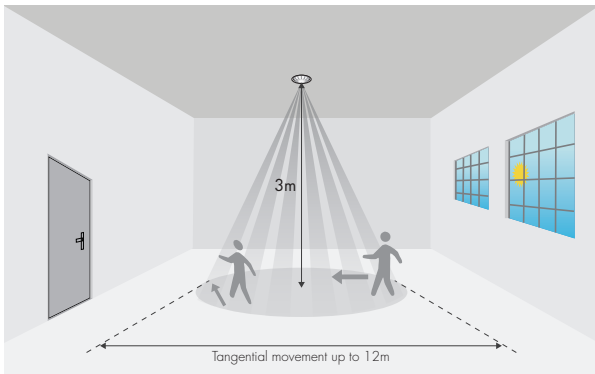

HIR62/R

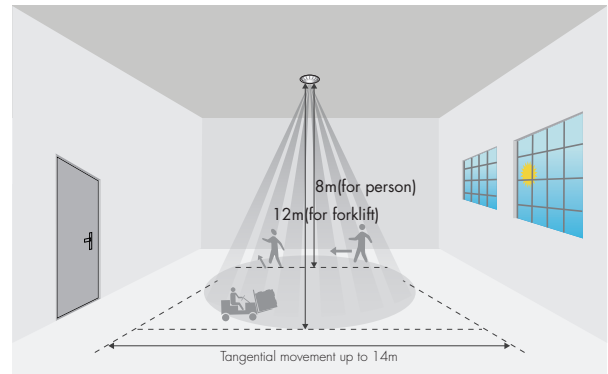

*The detection patterns are based upon 5km/h movement speed.

Dimming Interface Operation Notes

DALI

This series of products are supplied as 'plug n'play DALI' or 'independent DALI' system ready.

These models are also fully DALI addressable and may be assigned to groups within the limits specified by the DALI protocol or supporting DALI controllers by using a DALI programming tool.

Switch-Dim

The provided Switch-Dim interface allows for a simple dimming method using commercially available non-latching (momentary) wall switches. Up to 64 LED drivers may be connected to one switch.

Switch Action	Response
Short press (<0.4 second)	Toggle light on / off
Note: short press has to be longer than 0.1s, or it will be invalid.	
Long press (>0.4 second)	Toggle dim light / increase brightness

Synchronization

Switch Action	Response
Long press (>15 seconds)	All lights will dim down to minimum then return to 50% brightness

* We recommend the number of drivers connected to a switch does not exceed 25 pieces. The maximum length of the wires from push to driver should be no more than 20 meters.

Additional Information / Documents

1. For full explanation of Hytronik Photocell Advance™ technology, please kindly refer to [www.hytronik.com/download ->knowledge ->Introduction of Photocell Advance](http://www.hytronik.com/download->knowledge->Introduction%20of%20Photocell%20Advance)
2. To learn more about detailed product features/functions, please refer to [www.hytronik.com/download ->knowledge ->Introduction of App Scenes and Product Functions](http://www.hytronik.com/download->knowledge->Introduction%20of%20App%20Scenes%20and%20Product%20Functions)
3. Regarding precautions for Bluetooth product installation and operation, please kindly refer to [www.hytronik.com/download ->knowledge ->Bluetooth Products - Precautions for Product Installation and Operation](http://www.hytronik.com/download->knowledge->Bluetooth%20Products%20-%20Precautions%20for%20Product%20Installation%20and%20Operation)
4. Regarding precautions for microwave sensor installation and operation, please kindly refer to [www.hytronik.com/download ->knowledge ->Microwave Sensors - Precautions for Product Installation and Operation](http://www.hytronik.com/download->knowledge->Microwave%20Sensors%20-%20Precautions%20for%20Product%20Installation%20and%20Operation)
5. Regarding precautions for PIR Sensors installation and operation, please kindly refer to [www.hytronik.com/download ->knowledge ->PIR Sensors - Precautions for Product Installation and Operation](http://www.hytronik.com/download->knowledge->PIR%20Sensors%20-%20Precautions%20for%20Product%20Installation%20and%20Operation)
6. Regarding precautions for LED driver installation and operation, please kindly refer to [www.hytronik.com/download ->knowledge ->LED Drivers - Precautions for Product Installation and Operation](http://www.hytronik.com/download->knowledge->LED%20Drivers%20-%20Precautions%20for%20Product%20Installation%20and%20Operation)
7. Data sheet is subject to change without notice. Please always refer to the most recent release on [www.hytronik.com/products ->bluetooth technology ->Bluetooth Drivers](http://www.hytronik.com/products->bluetooth%20technology->Bluetooth%20Drivers)
8. Regarding Hytronik standard guarantee policy, please refer to [www.hytronik.com/download ->knowledge ->Hytronik Standard Guarantee Policy](http://www.hytronik.com/download->knowledge->Hytronik%20Standard%20Guarantee%20Policy)