

HEC7030/BF

Constant Current

HYTRONIK®



Product Description

HEC7030/BF is DALI-2 DT6 dimmable LED driver + Bluetooth sensor head in detached design with maximum power output of 30W. Such detached design is flexible with optional motion detection for lighting manufacturers; with Bluetooth sensor head unattached, HEC7030/BF is solely a DALI-2 DT6 LED driver; with Bluetooth sensor head attached, it becomes a LED driver + sensor combo. With Bluetooth wireless mesh networking, it makes communication between luminaires much easier without time-consuming hardwiring, which eventually saves costs for projects. Meanwhile, simple device setup and commissioning can be done via **Koolmesh**® app.



App Features

- Quick setup mode & advanced setup mode
- Floorplan feature to simplify project planning
- Web app/platform for dedicated project management
- Koolmesh Pro iPad version for on-site configuration
- Grouping luminaires via mesh network
- Scenes
- Detailed motion sensor settings
- Push switch configuration
- Schedule to run scenes based on time and date
- Astro timer (sunrise and sunset)
- Staircase function (primary & secondary)
- Internet-of-Things (IoT) featured
- Device firmware update over-the-air (OTA)
- Device social relations check
- Bulk commissioning (copy and paste settings)
- Power-on status (memory against power loss)
- Offline commissioning
- Different permission levels via authority management
- Network sharing via QR code or keycode
- Remote control via gateway support HBGW01
- Interoperability with Hytronik Bluetooth product portfolio
- Compatible with EnOcean switch HBES01/W & HBES01/B
- Continuous development in progress...

Hardware Features

- DALI-2 with DALI feedback
- Switch-Dim (Push switch)
- PWM 1KHz (1-100%)
- Stand-by power < 0.5W
- Active PFC design
- Logarithmic Dimming
- Linear Dimming
- Configurable constant current (CC) output via DIP switches
- Permanent setting memory, protected against loss of power
- Short-circuit Protection
- Open-circuit Protection
- Overload Protection
- 5-year warranty, designed for long lifetime up to 50,000 hours

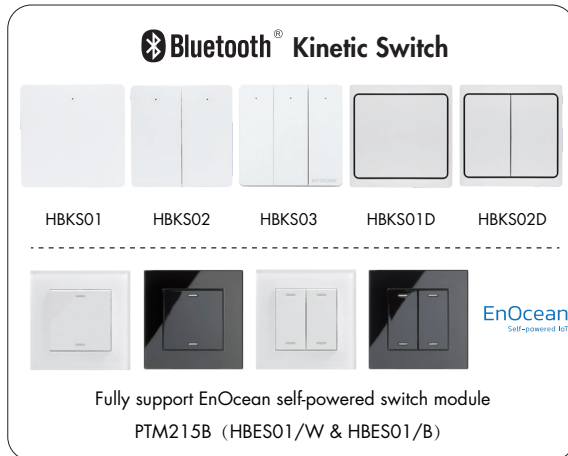

Bluetooth® 5.0 SIG mesh

IOS

for iOS

for Android

Smartphone app for both iOS & Android platform

for iPad

Koolmesh Pro app for iPad

Web

for Web

Web app/platform: www.iot.koolmesh.com

Output Configuration

HEC7030/BF,30W

900mA	● ● ● ●	
750mA	○ ● ● ●	
700mA	● ● ● ○	
550mA	○ ● ● ○	
500mA	● ● ○ ○	
350mA	○ ○ ○ ○	
	1 2 3	

Warning: Please make sure the correct current is selected before starting the driver!

Technical Specifications

Input	
Mains Voltage	220~240VAC 50/60Hz
Mains Current	0.17~0.16A
Power Factor	0.9
Max. Efficiency	86%

Output	
Output Current	350mA~900mA
Output Voltage	10-57V
Uout Max.	75V
Turn-on Time	<0.5s
Dimming Interface	Switch-Dim/DALI

Max. output power/current/voltage range	
HEC7030/BF	3.5-20W/350mA /10-57V
	5-29W/ 500mA /10-57V
	5.5-30W/ 550mA /10-55V
	7-30W/ 700mA /10-43V
	7.5-30W/ 750mA /10-40V
	9-23W/900mA /10-25V

Environment	
Operation Temp.	-20 ~ +50°C
Case Temp. (Max.)	80°C
IP Rating	IP20

Safety and EMC	
EMC Standard	EN55015, EN61547, EN61000-3-2/-3-3, EN62479
Safety Standard	EN61347-1, EN61347-2-13
Dielectric strength	Input→output: 3000VAC / 5mA / 1min
Abnormal protection	Output short-circuit protection Overload Protection Open-circuit Protection

Mechanical Structure & Dimensions

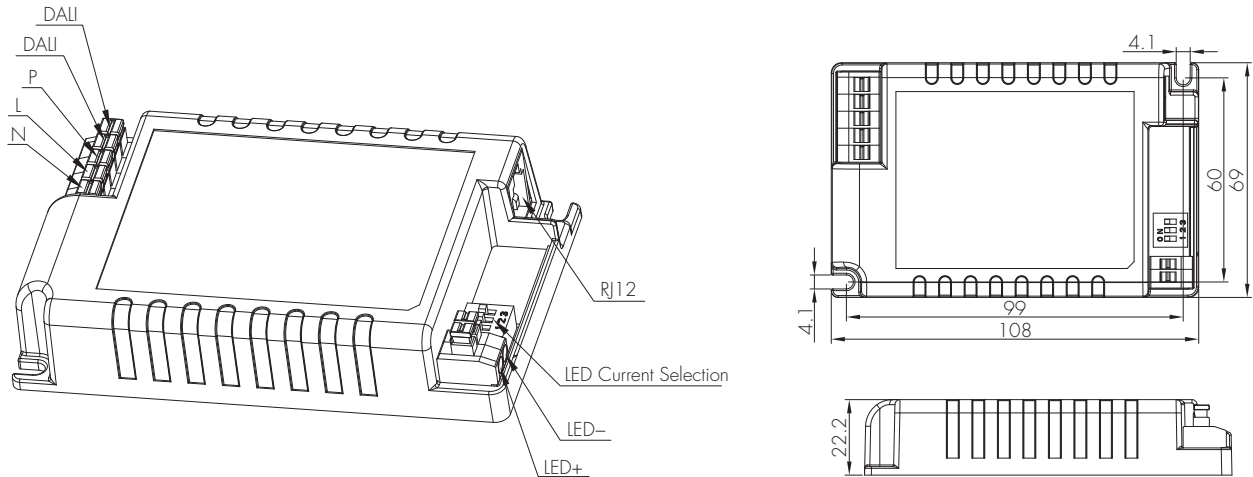

Wire Preparation

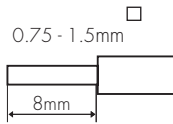
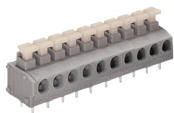

To make or release the wire from the terminal, use a screwdriver to push down the button.

1. 200 metres (total) max. for 1mm² CSA (Ta = 50°C)
2. 300 metres (total) max. for 1.5mm² CSA (Ta = 50°C)

Wiring Diagram

Note: If connecting a Bluetooth sensor antenna, the DALI inputs are disabled.

Wiring Diagram For DALI

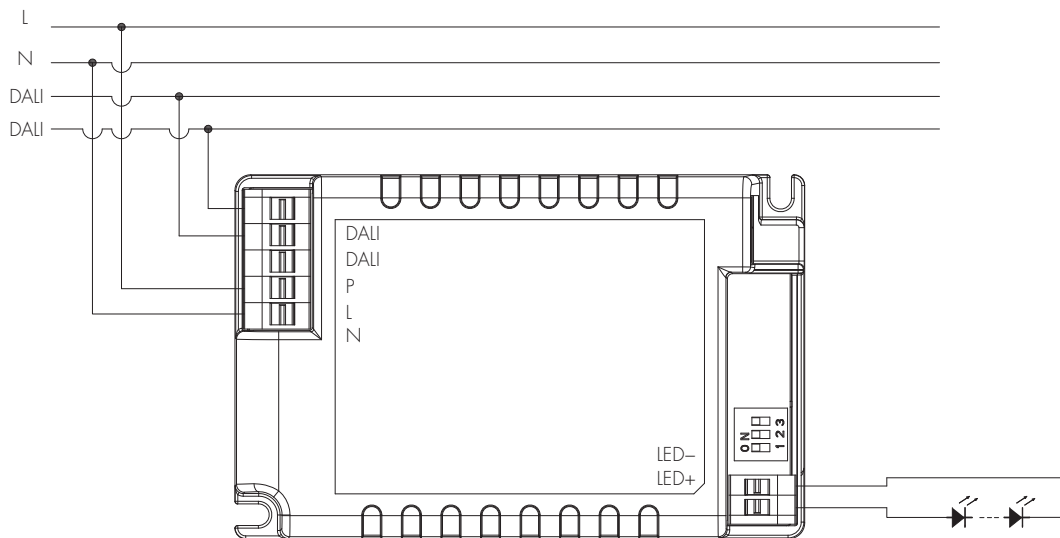

Wiring Diagram For Switch-Dim

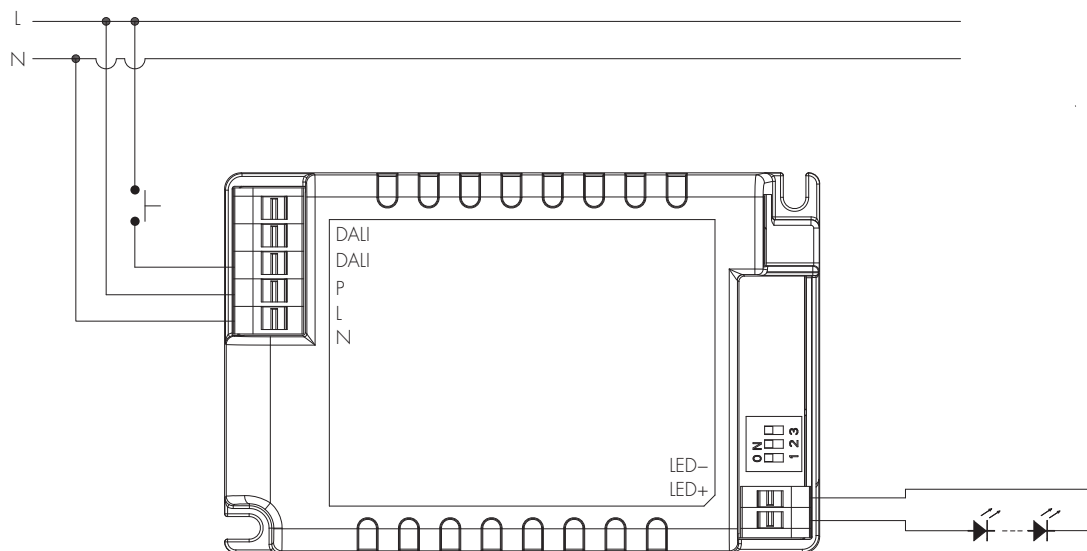

Wiring Diagram For Sensor Dim

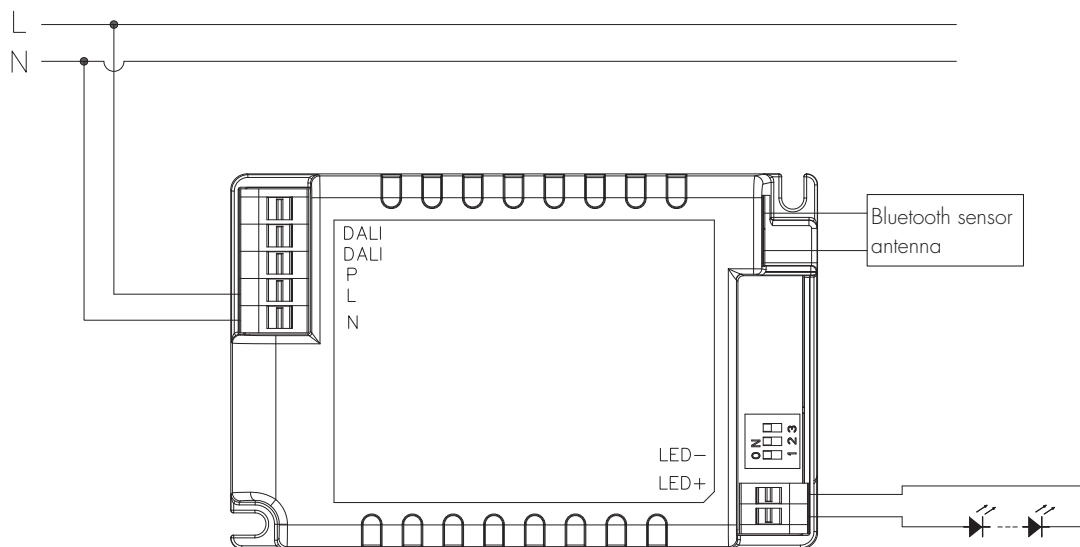

Loading and In-rush Current

Model	HEC7030/BF
In-rush Current (I _{max.})	38A
Pulse Time	35 μs

Circuit Breaker Information

Automatic circuit breaker type	B16A	B10A	B13A	B20A	B25A
HEC7030/BF	54	34	43	67	84

The data above is calculated according to the formula: Maximum Amount = $16/(P_n/230)$. In order to provide a more reliable reference in real application, the data have been revised to take 60% of the number calculated, i.e. $16/(P_n/230) \times 60\%$. Please kindly take note that the calculation is based on ABB circuit breaker series S200. Actual values may differ due to different types of circuit breaker used and installation environment.

Performance Characteristics

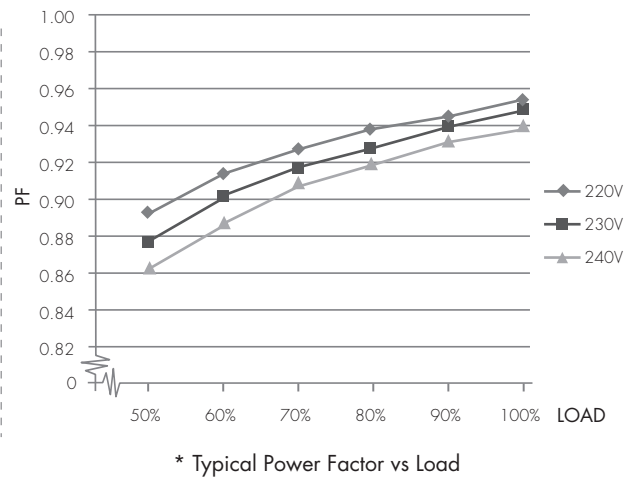
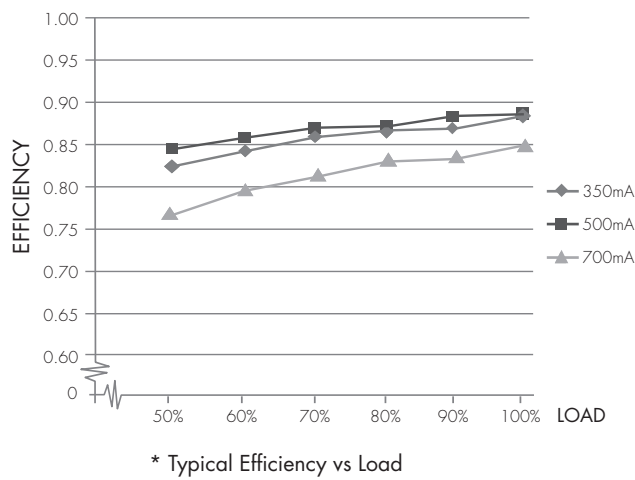

Dimming Characteristics

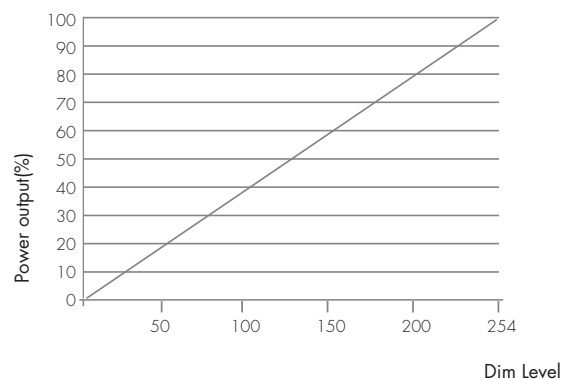
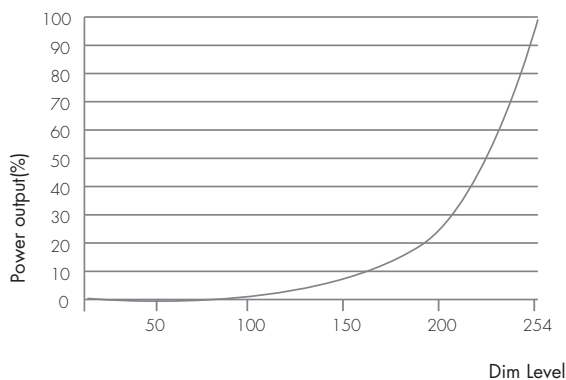

Technical Specifications for Sensor Heads

Bluetooth Transceiver	
Operation frequency	2.4 GHz - 2.483 GHz
Transmission power	4 dBm
Range (Typical indoor)	10~30m
Protocol	 Bluetooth® 5.0 SIG Mesh

HF Sensor Properties (HBT01)	
Sensor principle	High Frequency (microwave)
Operation frequency	5.8GHz +/- 75MHz
Transmission power	<0.2mW
Detection range*	Max installation height: 3m Max detection range: 8m (diameter)
Detection angle	30° ~ 150°

Environment	
Operation temperature	-20°C ~ 55°C
Storage temperature	Ta: -20°C ~ +70°C
Relative humidity	0 ~ 90%
IP rating	IP20

PIR Sensor Properties (HIR13 & HIR16 & HIR62 & HIR62/R)		
Sensor principle	PIR detection	
Operation voltage	5VDC	
Detection range *	HIR13 Max installation height: 15m (forklift) 12m (single person) Max detection range: 24m (diameter)	
	HIR16 Max installation height: 15m (forklift) 12m (single person) Max detection range: 18m * 6m (L * W)	
	HIR62 Max installation height: 3m (forklift) Max detection range: 12m (diameter)	
	HIR62/R Max installation height: 12m (forklift) 8m (single person) Max detection range: 20m (forklift) 12m (single person)	
	HIR17 Max installation height: 3m (single person) Max detection range (Ø): 12m	
	HIR17/R Max installation height: 8m (single person) Max installation height: 12m (forklift)	
	Detection angle	360°

* The detection range is heavily influenced by sensor placement (angle) and different walking paces. It may be reduced under certain conditions.

PIR & microwave sensor heads

The range of PIR and microwave sensor heads below with Bluetooth modules built in offers powerful number of Plug'n'Play feature options to expand the flexibility of luminaires design. This approach to luminaire design reduces space requirements and component costs whilst simplifying production.

A. HBT01

Surface mounting
Photocell Advance™
The cable length is around 30cm.

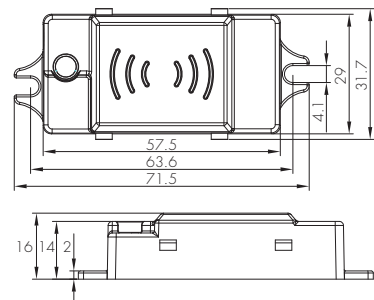
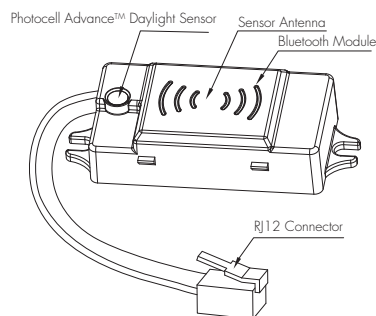

B. HBT02

Surface mounting
 Without motion sensor
 Photocell Advance™
 The cable length is around 30cm.

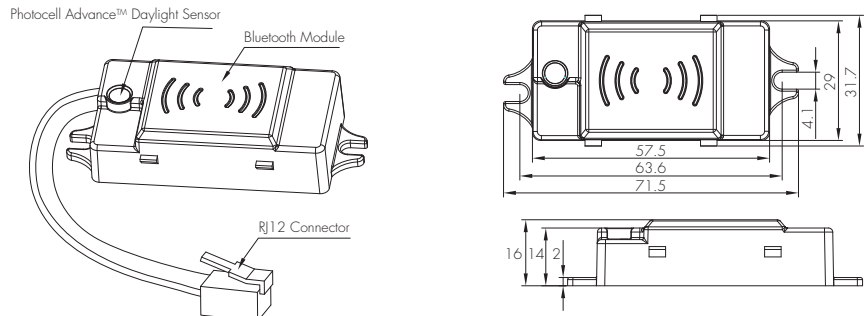

C. HIR13/S

Surface mounting
 For highbay application
 IP65 (facia / lens part)
 The cable length is around 30cm.

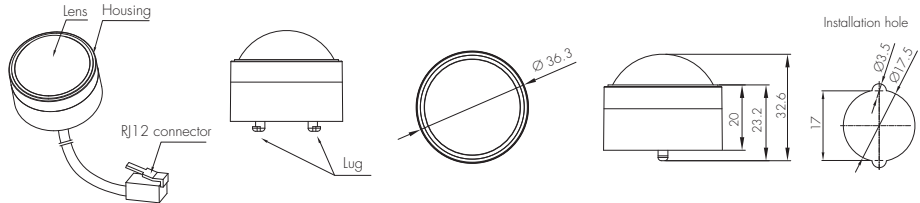

D. HIR13/F

Flush mounting
 For highbay application
 IP65 (facia / lens part)
 The cable length is around 30cm.

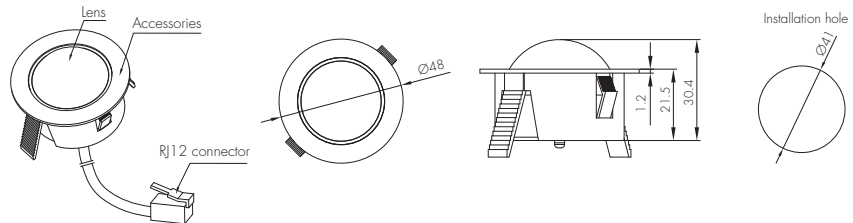

E. HIR13/C

Screw to the luminaire by conduit
 For highbay application
 IP65 (facia / lens part)
 The cable length is around 30cm.

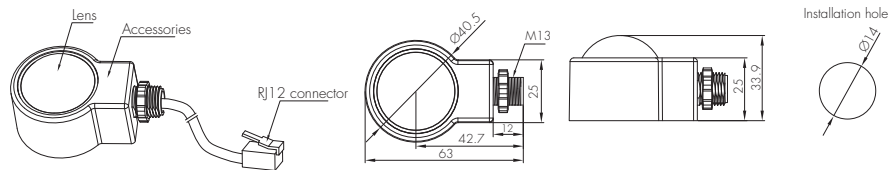

F. HIR16

PIR sensor head
 For highbay application
 IP65 (facia / lens part)
 The cable length is around 30cm.

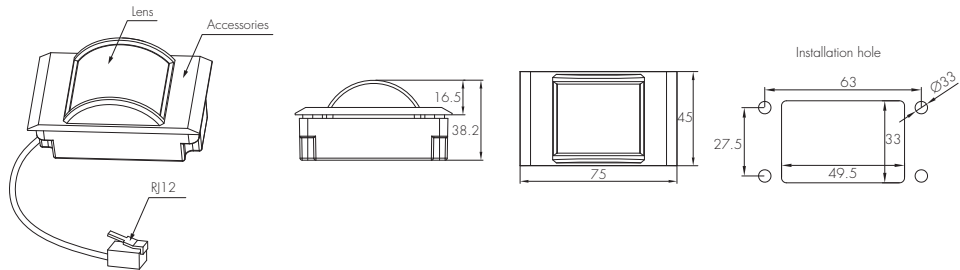

Installation for HIR16



We suggest that the metal plate thickness to be 0.8mm - 1.6mm to ensure perfect focal length for the PIR lens.

G. HIR62

PIR sensor head
 The cable length is around 30cm.

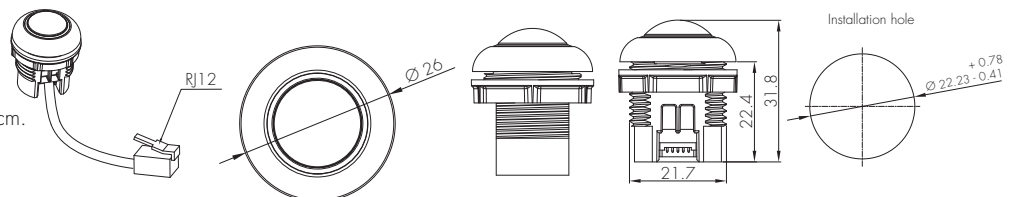

H. HIR62 with HA04

PIR sensor head
The cable length is around 30cm.

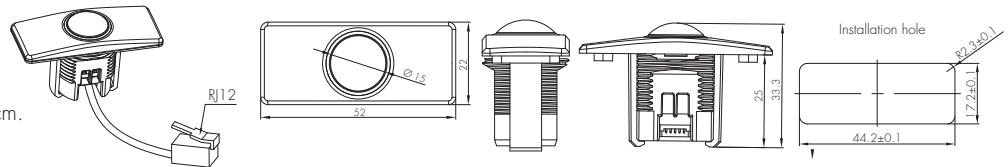

I. HIR62 with HA05

PIR sensor head
The cable length is around 30cm.

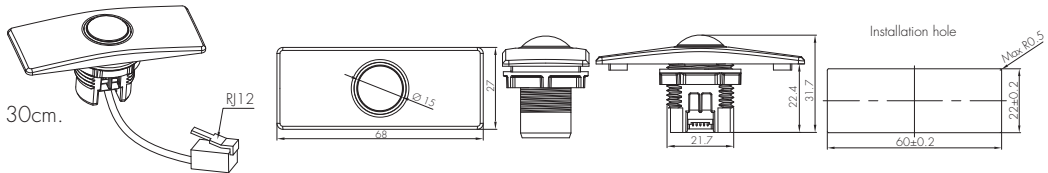

J. HIR62/R

PIR sensor head
IP65 (facia / lens part)
The cable length is around 30cm.

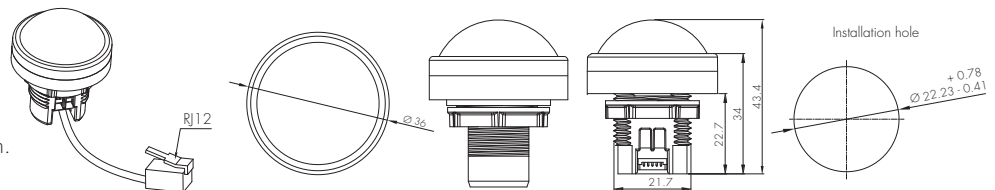

K. HIR17

PIR sensor head
The cable length is around 30cm.

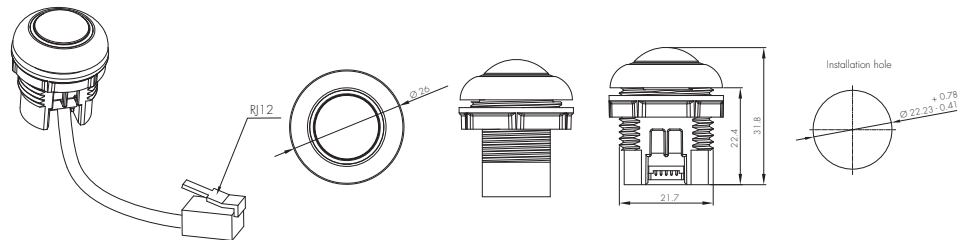

L. HIR17 with HA04

PIR sensor head
Optional accessory
The cable length is around 30cm.

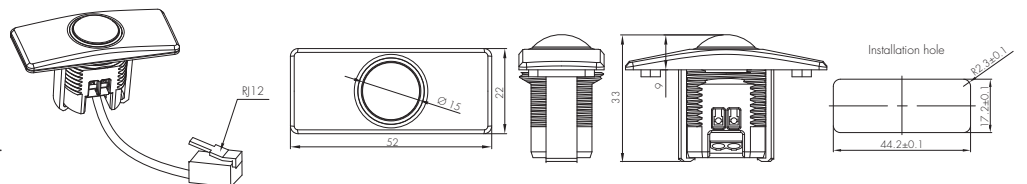

M. HIR17 with HA05

PIR sensor head
Optional accessory
The cable length is around 30cm.

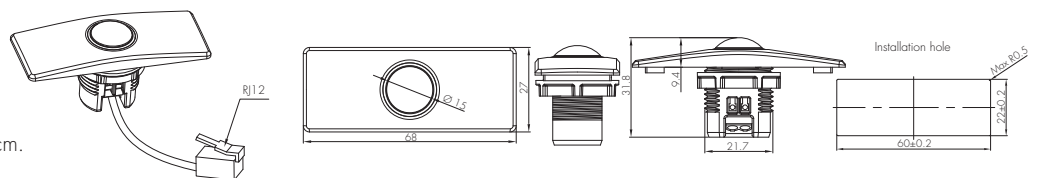

N. HIR17/R

PIR sensor head
IP65 (facia / lens part)
The cable length is around 30cm.

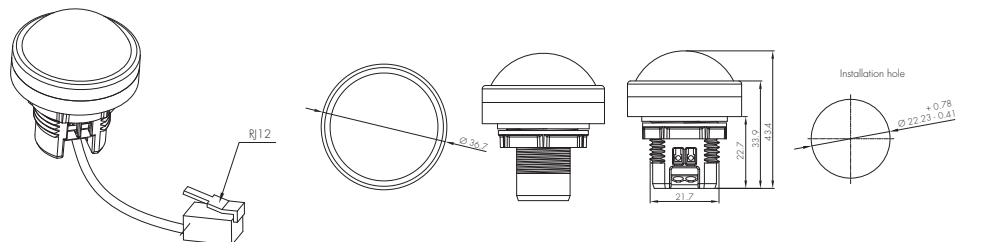

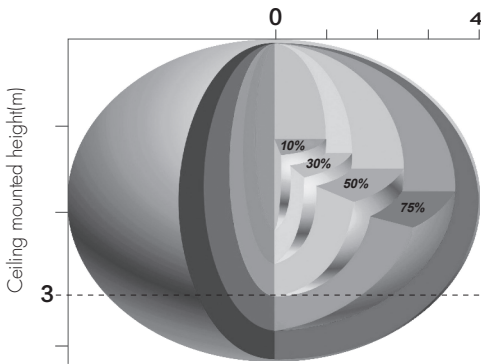

Detection Pattern

HBT01

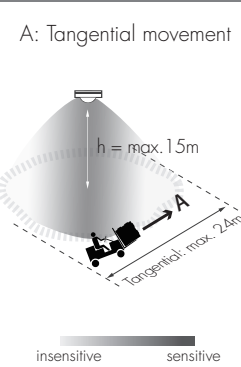
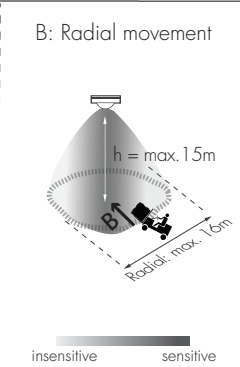

The detection range is heavily influenced by sensor placement (angle) and different walking paces.

It may be reduced to 2m(diameter) & 3m(height) under certain conditions (walking across).

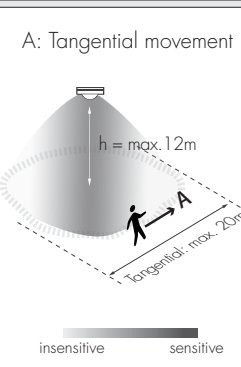
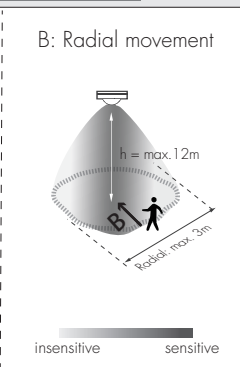
HIR13 (High-bay)				
		HIR13: High-bay lens detection pattern for <u>forklift</u> @ Ta = 20°C (Recommended installation height 10m-15m)		
A: Tangential movement	B: Radial movement	Mount height	Tangential (A)	Radial (B)
		10m	max 380m ² (Ø = 22m)	max 201m ² (Ø = 16m)
		11m	max 452m ² (Ø = 24m)	max 201m ² (Ø = 16m)
		12m	max 452m ² (Ø = 24m)	max 201m ² (Ø = 16m)
		13m	max 452m ² (Ø = 24m)	max 177m ² (Ø = 15m)
		14m	max 452m ² (Ø = 24m)	max 133m ² (Ø = 13m)
		15m	max 452m ² (Ø = 24m)	max 113m ² (Ø = 12m)
		HIR13: High-bay lens detection pattern for <u>single person</u> @ Ta = 20°C (Recommended installation height 2.5m-12m)		
A: Tangential movement	B: Radial movement	Mount height	Tangential (A)	Radial (B)
		2.5m	max 50m ² (Ø = 8m)	max 7m ² (Ø = 3m)
		6m	max 104m ² (Ø = 11.5m)	max 7m ² (Ø = 3m)
		8m	max 154m ² (Ø = 14m)	max 7m ² (Ø = 3m)
		10m	max 227m ² (Ø = 17m)	max 7m ² (Ø = 3m)
		11m	max 269m ² (Ø = 18.5m)	max 7m ² (Ø = 3m)
		12m	max 314m ² (Ø = 20m)	max 7m ² (Ø = 3m)

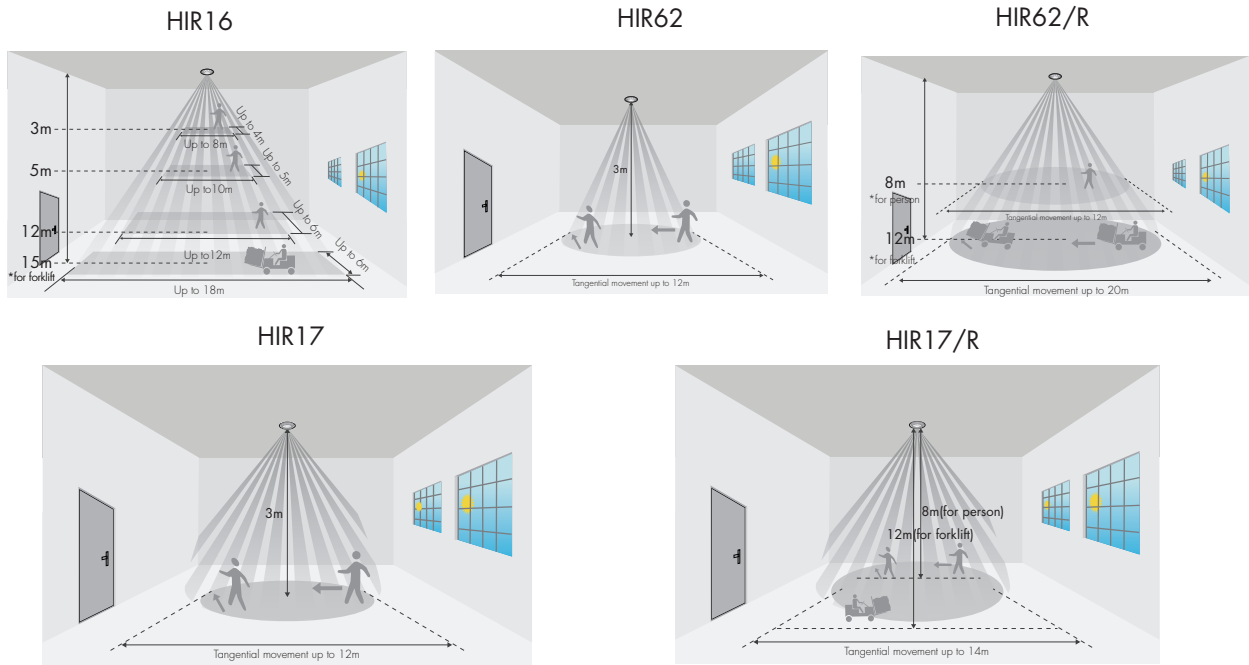

*The detection patterns are based upon 5km/h

Dimming Interface Operation Notes

DALI

This series of products are supplied as 'plug n'play DALI' or 'independent DALI' system ready.

These models are also fully DALI addressable and may be assigned to groups within the limits specified by the DALI protocol or supporting DALI controllers by using a DALI programming tool.

Switch-Dim

The provided Switch-Dim interface allows for a simple dimming method using commercially available non-latching (momentary) wall switches. Up to 64 LED drivers maybe connected to one switch.

Switch Action

Short press (<0.4 second)

Note: short press has to be longer than 0.1s, or it will be invalid.

Long press (>0.4 second)

Response

Toggle light on / off

Toggle dim light / increase brightness

Synchronization

Switch Action

Long press (>15 seconds)

Response

All lights will dim down to minimum then return to 50% brightness

* We recommend the number of drivers connected to a switch does not exceed 25 pieces. The maximum length of the wires from push to driver should be no more than 20 meters.

Additional Information / Documents

1. For full explanation of Hytronik Photocell Advance™ technology, please kindly refer to [www.hytronik.com/download ->knowledge ->Introduction of Photocell Advance](http://www.hytronik.com/download->knowledge->Introduction%20of%20Photocell%20Advance)
2. To learn more about detailed product features/functions, please refer to [www.hytronik.com/download ->knowledge ->Introduction of App Scenes and Product Functions](http://www.hytronik.com/download->knowledge->Introduction%20of%20App%20Scenes%20and%20Product%20Functions)
3. Regarding precautions for Bluetooth product installation and operation, please kindly refer to [www.hytronik.com/download ->knowledge ->Bluetooth Products - Precautions for Product Installation and Operation](http://www.hytronik.com/download->knowledge->Bluetooth%20Products%20-%20Precautions%20for%20Product%20Installation%20and%20Operation)
4. Regarding precautions for microwave sensor installation and operation, please kindly refer to [www.hytronik.com/download ->knowledge ->Microwave Sensors - Precautions for Product Installation and Operation](http://www.hytronik.com/download->knowledge->Microwave%20Sensors%20-%20Precautions%20for%20Product%20Installation%20and%20Operation)
5. Regarding precautions for PIR Sensors installation and operation, please kindly refer to [www.hytronik.com/download ->knowledge ->PIR Sensors - Precautions for Product Installation and Operation](http://www.hytronik.com/download->knowledge->PIR%20Sensors%20-%20Precautions%20for%20Product%20Installation%20and%20Operation)
6. Regarding precautions for LED driver installation and operation, please kindly refer to [www.hytronik.com/download ->knowledge ->LED Drivers - Precautions for Product Installation and Operation](http://www.hytronik.com/download->knowledge->LED%20Drivers%20-%20Precautions%20for%20Product%20Installation%20and%20Operation)
7. Data sheet is subject to change without notice. Please always refer to the most recent release on [www.hytronik.com/products/bluetooth technology ->Bluetooth Drivers](http://www.hytronik.com/products/bluetooth%20technology->Bluetooth%20Drivers)
8. Regarding Hytronik standard guarantee policy, please refer to [www.hytronik.com/download ->knowledge ->Hytronik Standard Guarantee Policy](http://www.hytronik.com/download->knowledge->Hytronik%20Standard%20Guarantee%20Policy)