





SAM12/RC05**Product Description**

SAM12/RC05 is a sensor head only with 12VDC input and 5V 1kHz PWM / 1-10V output, it 's ready to be integrated into a third-party LED driver, no control base needed. It is suitable for bulkhead, tri-proof, LED panel, linear, pendant, highlight.

**Hardware Features**

-  5V 1kHz PWM / 1-10V output
-  Tri-level dimming control based upon occupancy (also known as corridor function)
-  Robust HF antenna design wireless interference
-  5-year warranty

Technical Specifications

Input & Output Characteristics	
Input	12VDC
Output	5V 1kHz PWM/0-10V
Stand-by power	<0.3W
Sensitivity	50% / 100%
Hold-time	2s / 30s / 1min / 5min / 10min / 30min
Stand-by time	0s / 10s / 1min / 5min / 10min / 30min +∞
Stand-by dim level	10% / 20% / 30%
Daylight sensor	2lux, 10lux, 50lux, disable

Sensor Data	
Operation frequency	5.8 GHz +/- 75MHz
Transmitting power	<0.2mW
Detection range*	Max installation height: 6m Max detection range (∅): 10m
Detection angle	30° ~ 150°

Environment	
Operation temperature	Ta: -20°C ~ +60°C
IP rating	IP20

* The detection range is heavily influenced by sensor placement (angle) and different walking paces. It may be reduced under certain conditions.

Mechanical Structure & Dimensions

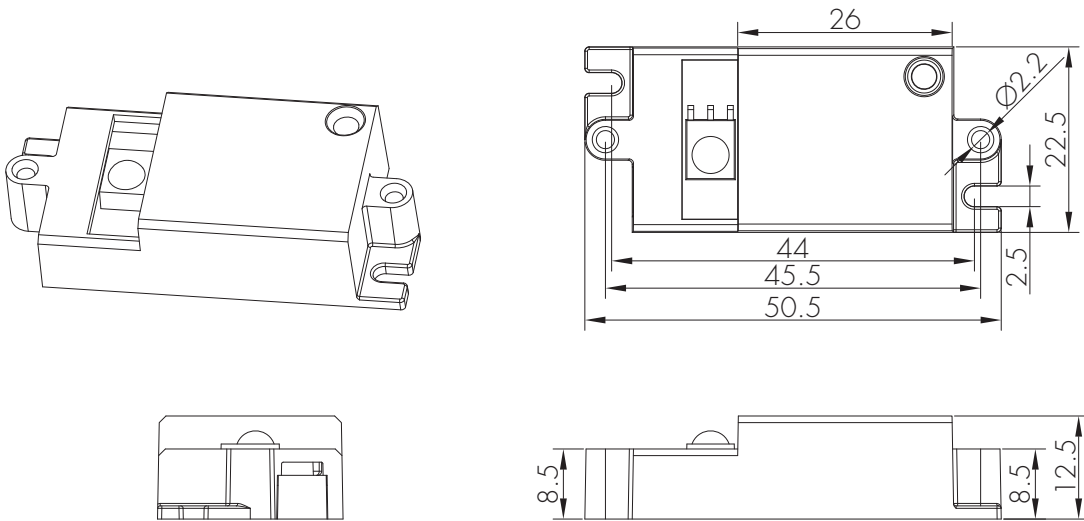

Wiring Diagram

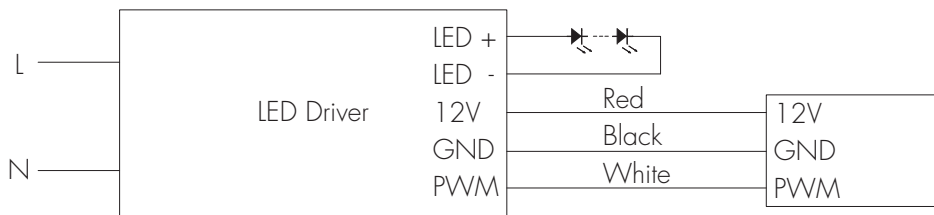

Functions and Features

1 Tri-level Control (Corridor Function)

Hytronik builds this function inside the motion sensor to achieve tri-level control, for some areas which require a light change notice before switch-off. The sensor offers 3 levels of light: 100%→dimmed light (natural light is insufficient) →off; and 2 periods of selectable waiting time: motion hold-time and stand-by period; Selectable daylight threshold and freedom of detection area.

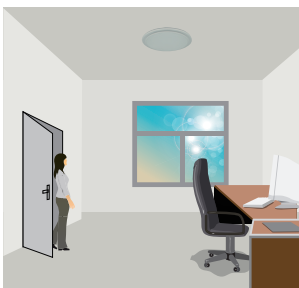

With sufficient natural light, the light does not switch on when presence is detected.

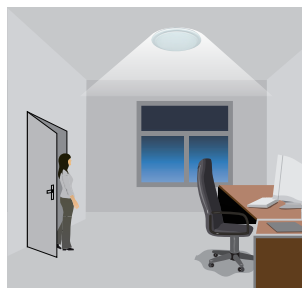

With insufficient natural light, the sensor switches on the light automatically when presence is detected.

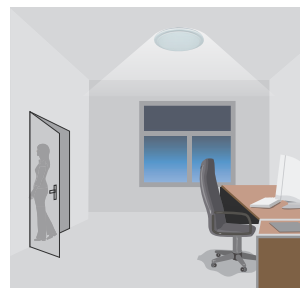

After hold-time, the light dims to stand-by level if the surrounding natural light is below the daylight threshold.



Light switches off automatically after the stand-by period elapses.

Detection Pattern

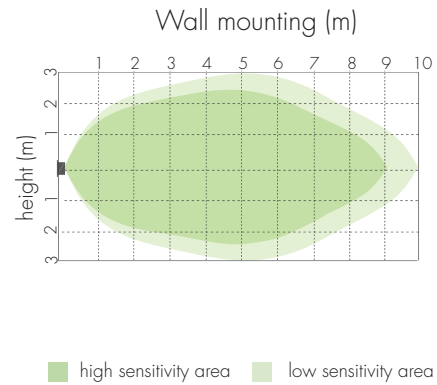
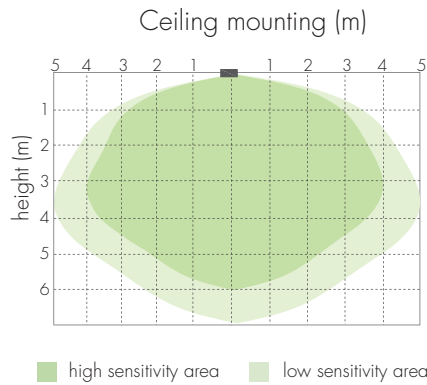

Settings (Remote Control HRC-05)



Permanent ON/OFF function

Press the "ON/OFF" button, the light goes to permanent on or permanent off mode, and the sensor is disabled.

* Press "Auto Mode", "RESET" or "Scene mode" buttons to quit this mode.

The mode will change to AUTO Mode after power failure.



Sensor mode

Press "Auto Mode" button, the sensor starts to function and all settings remain the same as the latest status before the light is switched on/off.



Reset function

Press "RESET" button, all settings go back to default settings.



Dim +/-

Long press "Dim +" or "Dim -" to adjust the target lux level during hold-time. "+" means increasing the target, "-" means decreasing the target.



Test mode

This button is for testing purpose only. The sensor goes to test mode (hold-time is 2s) after commissioning, meanwhile the stand-by period and daylight sensor are disabled.

* This mode can be ended by pressing "reset", or any button of "scene mode" and "hold-time". The sensor settings are changed accordingly.



Power output

By pressing these two buttons, the output shifts between 80% (at initial 10,000 hours) and 100%, for energy saving purpose.

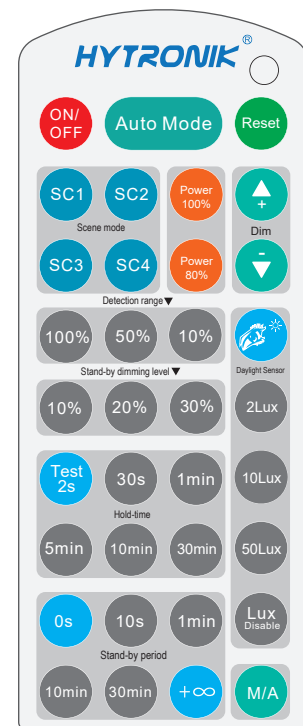

HRC-05

Note: the light will flash ONCE rapidly after receiving the command from the remote control successfully.

Lux disable

Press this button, the built-in daylight sensor stops working, and all motion detected could turn on the lighting fixture, no matter how bright the natural light is.

Scene mode

There are 4 scene modes fixed program built in the remote control to choose for different applications:

Scene options	Detection range	Hold-time	Stand-by period	Stand-by dimming level	Daylight sensor
SC1	100%	1 min	10min	10%	2Lux
SC2	100%	5min	10min	10%	2Lux
SC3	100%	10min	30min	10%	10Lux
SC4	100%	10min	+∞	10%	50Lux

* End-user can adjust the settings by pressing buttons of detection range/hold-time/stand-by period/stand-by dimming level/daylight sensor. The last setting stays in validity.

Detection range

Press the buttons of "detection range" to set detection range at 10% / 50% / 100%.

Hold-time

Press the buttons of "hold-time" to set hold-time at 2s / 30s / 1 min / 5min / 10min.

Daylight sensor

Press the buttons of "daylight sensor" to set daylight threshold at 2Lux / 10Lux / 50Lux. The fixture will not turn on if ambient natural light lux level exceeds the threshold preset when motion detected.

Stand-by period (corridor function)

Press the buttons of "stand-by period" to set stand-by period at 0s / 10s / 1 min / 10min / 30min / +∞.

* "0s" means on/off control; "+∞" means bi-level dimming control, and the fixture never switches off.

Stand-by dimming level

Press the buttons of "stand-by dimming level" to set the stand-by dimming level at 10% / 20% / 30%.

Additional Information / Documents

1. Regarding precautions for microwave sensor installation and operation, please kindly refer to [www.hytronik.com/download ->knowledge ->Microwave Sensors - Precautions for Product Installation and Operation](http://www.hytronik.com/download->knowledge->Microwave+Sensors+-+Precautions+for+Product+Installation+and+Operation)
2. Regarding Hytronik standard guarantee policy, please refer to [www.hytronik.com/download ->knowledge ->Hytronik Standard Guarantee Policy](http://www.hytronik.com/download->knowledge->Hytronik+Standard+Guarantee+Policy)