

Flush Mount Occupancy Motion Sensor



HMW28VFC/PRO

On/off control & Low-bay

HYTRONIK®



Product Description

HMW28VFC/PRO is Microwave standalone motion sensor integrated with Hytronik True Occupancy detection technology, On/Off control with one relay channel output, which is NO (normally open contact). The Hytronik True Occupancy detection technology works to detect human breathing rather than the mirror movements. No matter if the person sit/stand statically or turns their back to the sensor. The sensor accurately recognizes occupancy and keeps the lights on continuously, making it highly suitable for stable and peaceful environments such as offices and hotels, though not recommended for industrial settings.



Features



Store settings in the remote for easy commissioning when programming multiple sensors



Intelligent photodiode - lights and sensors only operate when needed, natural light has priority



Max withstandable in-rush current: 120A@160µs



VFC: Volt-free Contact/Dry Contact ON/OFF relay switch

– 24VDC@5A

– 250VAC@5A



NO contact



Black & White & Gray metal surface mount box option



User-friendly design for installation



5 Year warranty

Technical Data

Input Characteristics

Mains voltage	220~240VAC 50/60Hz
Stand-by power	<0.3W
Max withstandable in-rush current	120A@160µs
VFC: Volt-free Contact /Dry Contact	– 24VDC@5A – 250VAC@5A

Safety and EMC

EMC standard (EMC)	EN61547, EN55015, EN61000-3-2/-3-3
Safety standard (LVD)	EN60669-1, EN60669-2-1
RED	EN300400, EN301489-1/-3/-17 EN50663, EN30328
Certification	UKCA, CE, RCM

Sensor Data

Sensor Model	Occupancy Motion detection
Detection range (Max.)*	Installation Height : 3m Detection Range(Ø) : 10m
Detection angle	360°

* For more details of detection range, please refer to "detection pattern" section.

Environment

Operation temperature	Ta: -20°C ~ +50°C
Storage temperature	-40°C ~ +70°C
IP rating	IP20
Relative humidity	10 ~ 90%

Mechanical Structure

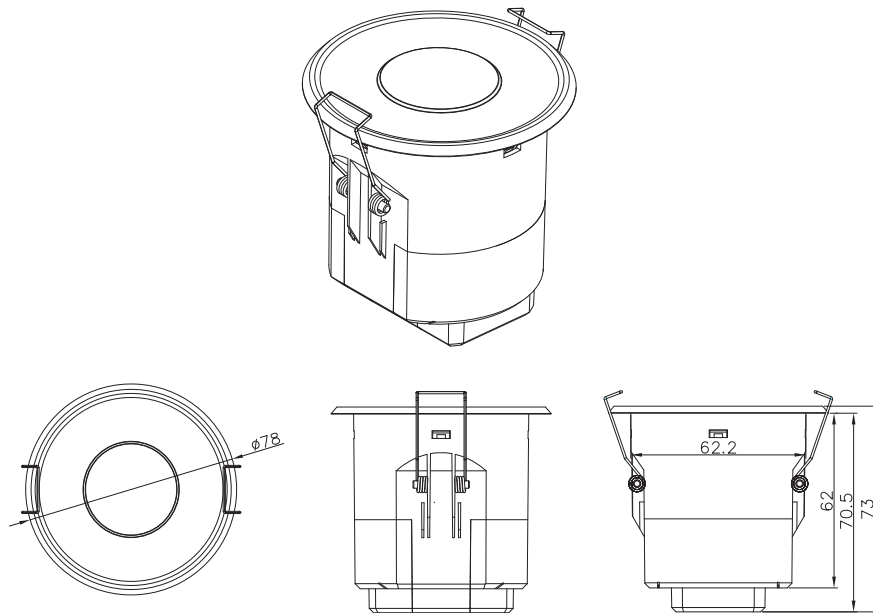

Wiring Diagram

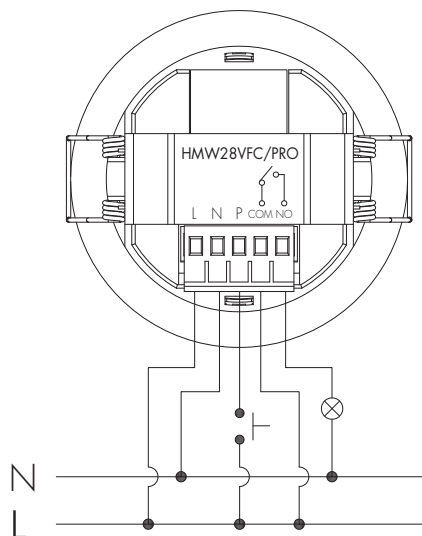

Wire Preparation

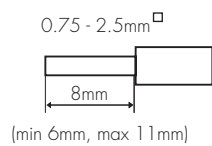

Pluggable screw terminal. It is recommended to make connections to the terminal before fitting to the sensor.

Sensor Installation and Commissioning Guidelines

A. Installation Preparation

1. Make sure the room is empty with no moving people or machinery when first powered up for 1 minute.
2. There is a 20-second warm-up time for the sensor. Please do the commissioning after warm-up.
3. When the sensor is powered off, repeat the initial steps once it's re-powered

B. Sensor Placement

1. The distance between sensors should be at least 3 meters.
2. Sensors should not directly face sources of microwave interference, such as other microwave sensors, microwave ovens, or wireless routers. Maintain a distance of at least 3 meters.
3. The installation environment should avoid object vibrations, strong airflows, curtain movements, water flow in pipes, window glass vibrations, and wind-induced movements of metal roofs. Aim for a stable environment with minimal variables.
4. The sensor is highly sensitive and suitable for stable and quiet environments like offices and hotels, but not for industrial settings.

C. Sensor Operation

1. Movements within 0.3 meters of the sensor, such as waving an arm, might not trigger the sensor, as it will identify and filter out such large movements.
2. In test mode, a red LED will flash when the sensor is triggered. There are no visual indications in normal mode.
3. If the sensor is too sensitive, use the HRC-12 remote controller to lower the sensitivity.
4. Avoid accidentally entering semi-auto mode.
5. Pay attention to the daylight sensor threshold value, which needs to be adjusted according to the installation environment.

Detection Pattern

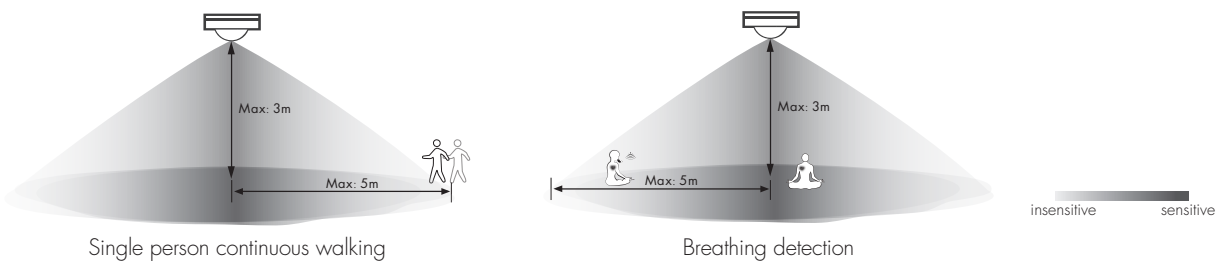

When it's in breathing & true Occupancy detection mode and in sitting situation, facing to sensor directly will have a better detection range than 90 degrees side facing to

Optional Accessory --- Ceiling/Surface Metal Mount Box: HA09/W, HA09/B, HA09/G

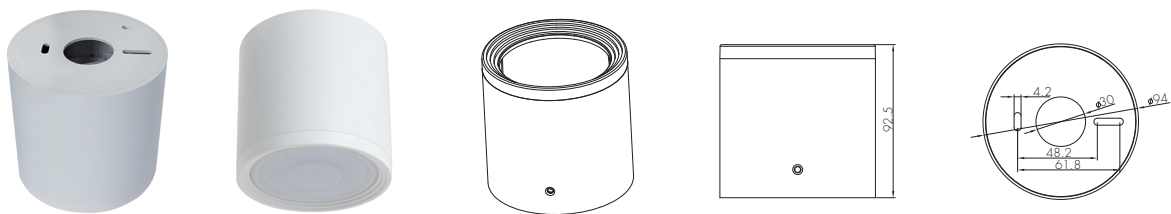

Optional Accessory --- HA08

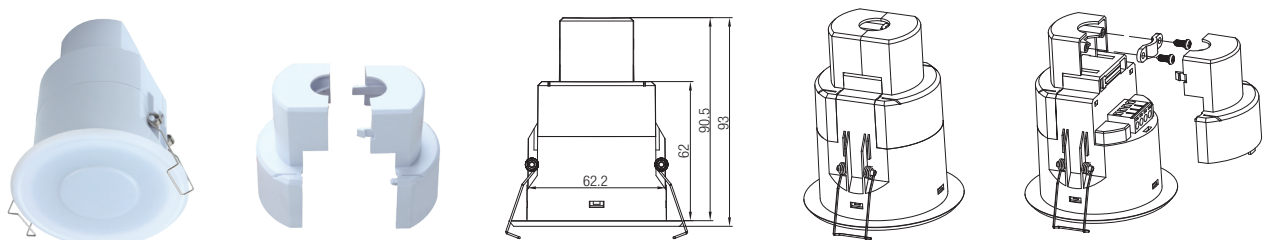

*Note: Optional Accessory HA09 & HA08 can not be used together.

Big and small silicon gasket used to make IP54 degree protection when mounted into HA09 housing for ceiling mount

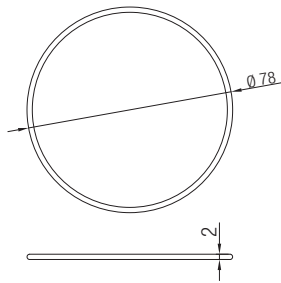

Small silicon water-proof gasket dimension(size:mm)

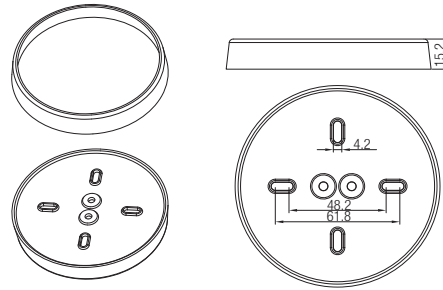

Big silicon water-proof gasket dimension(size:mm)

Functions and Features

1 On/ off Control

This sensor is a motion switch, which turns on the light upon detection of motion or breathing, and turns off after a pre-selected hold-time when there is no movement or breathing. A daylight sensor is also built in to prevent the light from switching on when there is sufficient natural light.

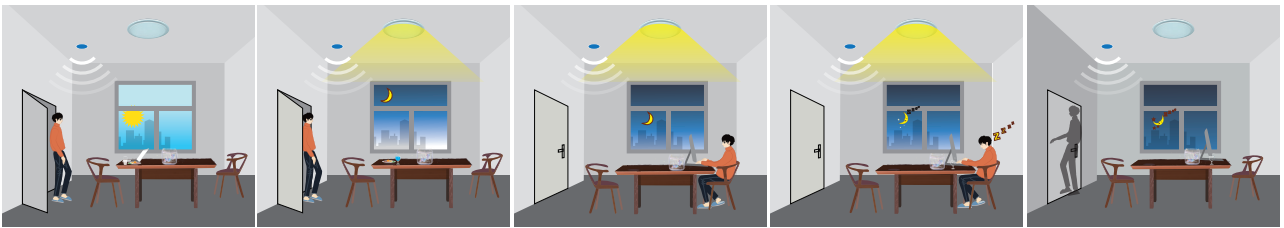

2 Lux Off Function

The built-in photodiode will also automatically turn off the light when the ambient natural light exceeds the programmed lux level for more than 5min, regardless of whether motion is detected or not.

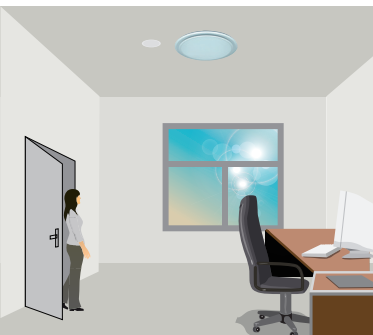

With sufficient natural light, the light does not switch on when Occupancy is detected.

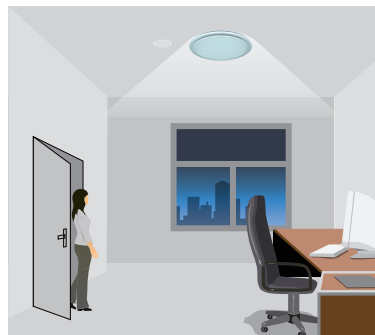

With insufficient natural light, the sensor switches on the light automatically when Occupancy is detected.

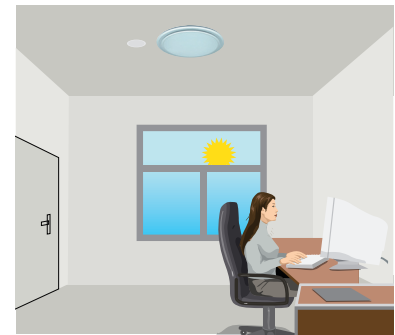

The sensor switches off the light when natural light is sufficient, even with Occupancy.

3 Manual Override

With the help of push-switch, this sensor can be over-riden by the end-user to manually switch on/off the light, which makes the product more user-friendly and offers more options to fit some extra-ordinary demands:

* Short Push (< 1 s): on/off function;

On → Off: the light turns off immediately and cannot be triggered ON by motion until the expiration of pre-set hold-time. After this period, the sensor goes back to normal sensor mode.

Off → On: the light turns on and goes to sensor mode, no matter if ambient Lux level exceeds the daylight threshold or not.

Note: if end-user do not want this manual override function, just leave the "push" terminal unconnected to any wire.

4 Semi-auto Mode (Absence Detection)

It is easy to forget to switch off the light, in office, corridor, even at home. And in many other cases, people do not want to have a sensor to switch on the light automatically, for example, when people just quickly pass-by, there is no need to have the light on. The solution is to apply this "absence detector": motion sensor is employed, but only activated on the manual press of the push-switch, the light keeps being ON in the Occupancy, and switches off in the long absence.

Note: end-user can choose either function 3 or function 4 for application. Default function is manual override.

Settings (Remote Control HRC-12)

ON / OFF

Permanent ON/OFF function

Press button "ON/OFF" to select permanent ON or permanent OFF mode.

* Press button "AUTO", "RESET" or "Ambient" to quit this mode.

The mode will change to AUTO Mode after power failure.

RESET

Reset Settings

Press button "RESET", all settings go back to default values as below:

Detection range: 100%; Hold-time: 5min; Lux disabled

AUTO

Sensor mode

Press "Auto Mode" button, the sensor starts to function and all settings remain the same as the latest status before the light is switched on/off.

SEMI
AUTO

SEMI-AUTO mode

Press "SEMI-AUTO" button, to enter semi-auto mode. The fixture is manually on by push-switch and automatically off in this mode.

Detection range

Press buttons in zone "HF sensor Detection range" to set detection range at 100% / 75% / 50% / 10%.

Daylight threshold

Press buttons in zone "Daylight threshold" to set daylight sensor at 2Lux / 10Lux / 50Lux / 100Lux / 300Lux / 500Lux / Disable.

Ambient daylight threshold

Press button "Ambient", the surrounding lux level is sampled and set as the new daylight threshold.

Hold-time

Press buttons in zone "hold-time" to set the hold-time at 5sec / 1min / 5min / 10min / 15min / 30min / 60min.

Note: 1. 5sec is test mode.

2. Press button 30min / 60min, the actual setting is 25min.

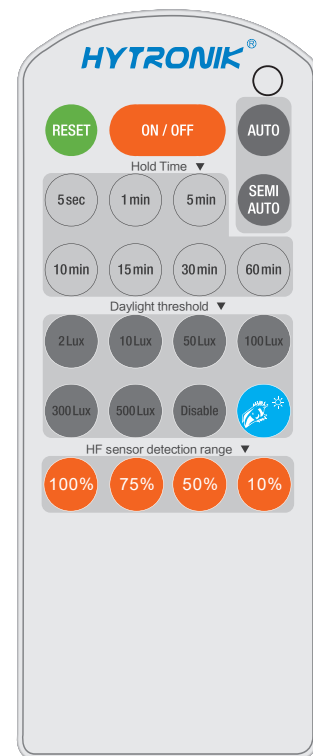

HRC-12

Additional Information / Documents

1. Regarding precautions for HF sensor installation and operation, please kindly refer to [www.hytronik.com/download ->knowledge ->Microwave Sensors - Precautions for Product Installation and Operation](http://www.hytronik.com/download->knowledge->Microwave%20Sensors%20-%20Precautions%20for%20Product%20Installation%20and%20Operation)
2. Regarding Hytronik standard guarantee policy, please refer to [www.hytronik.com/download ->knowledge ->Hytronik Standard Guarantee Policy](http://www.hytronik.com/download->knowledge->Hytronik%20Standard%20Guarantee%20Policy)