

SURFACE MOUNT DUAL SENSE MOTION SENSOR HIM54



1. Technical Specifications

Product type	Dual sense DALI sensor (HF and PIR, daylight harvest)
Operating voltage	220–240VAC 50/60Hz
Switched power	Maximum 20pcs devices, maximum 40mA
Power consumption	< 1W
Detection angle	360°
Detection area (Max.)*	Installation Height : 6m Detection Range (Ø) :12m
Detection range	10% / 50% / 75% / 100%
Hold time	2s / 30s / 1min / 5min / 10min / 15min / 20min / 30min
Stand-by time	0s / 10s / 1min / 5min / 10min / 30min / 1h / +∞
Stand-by dimming level	10% / 20% / 30% / 50%
Daylight threshold	50 – 500Lux, Disable
Warming up time	30s
Operating temperature	-20°C – +55°C
Sensor mode	PIR, HF, PIR+HF, PIR / HF

3. Rotary Switch Settings

A rotary switch is built inside the sensor for scene selection / fast programming. Total 16 channels available:



Rotary switch preset (Please see the location in 2. Installation)

Channel	Detection range	Hold time	Stand-by time	Stand-by dimming level	Daylight threshold
0	100%	5s	10s	10%	Disable
1	100%	1min	5min	10%	50Lux
2	100%	5min	10min	10%	50Lux
3	100%	5min	+∞	10%	75Lux
4	100%	5min	+∞	10%	100Lux
5	100%	5min	+∞	30%	200Lux
6	100%	10min	30min	10%	50Lux
7	100%	10min	+∞	10%	75Lux
8	100%	10min	+∞	10%	100Lux
9	100%	10min	+∞	30%	200Lux
A	100%	20min	1h	10%	100Lux
B	100%	20min	+∞	30%	200Lux
C	100%	30min	+∞	10%	100Lux
D	100%	30min	+∞	30%	200Lux
E	100%	30min	+∞	50%	400Lux
F	100%	5s	10s	10%	100Lux

Note: settings can also be changed by remote control HRC-11. The last action controls.

5. Functions

5.1 Daylight Harvest (Daylight Regulating)

The built-in daylight sensor can measure ambient natural light, and calculate how much electrical light is needed to reach the target lux level. The demand is given to the LED driver by DALI signal, so as to deliver the needed amount of electric light. The target lux level can be adjusted by remote control or long press on the push switch.

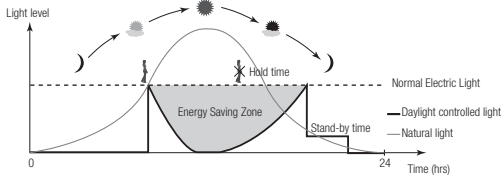

5.2 Lux Off Function

The light dims to minimum level even switches off completely if ambient daylight is sufficient (natural light level exceeds target lux level), no matter it is during hold-time or stand-by-time, with or without motion. Note: if the stand-by time is preset at "+∞", the light never turns off even when natural light is sufficient.

2. Installation

⚠ Warnings:

1. Installation must be carried out by a qualified engineer in accordance with local regulations.
2. Disconnect supply before installing.
3. Install to a solid surface - vibrations may cause mis-triggering.
4. Ensure environmental conditions are suitable for electronic equipment

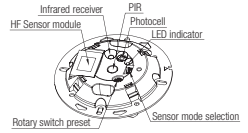

A - Control Board

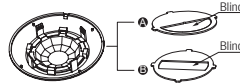

Note: the blinds are optional, they may be inserted behind the lens for focussing the detection range.

Casing option 1

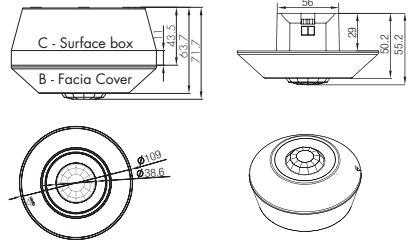

Casing option 2

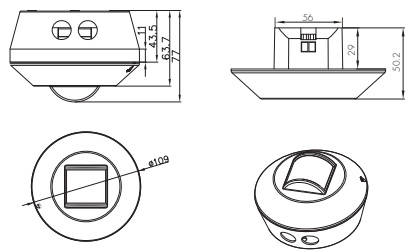

Direct junction "J" box mounting

1. Separate control board (A) from facia (B) & junction box (C).
2. Make electrical connections to control board (A). See detailed wiring diagram on next page.
3. Secure control board (A) to junction box.
4. Set-up sensor modes as per sections 3 & 4 of this manual.
5. Clip facial plate (B) to control board (A).

Surface mount assembly

1. Separate control board (A) from facia (B) & Surface box (C).
2. Securely mount surface box (C) to a flat and solid surface.
3. Make electrical connections to control board (A). See detailed wiring diagram on next page.
4. Set-up sensor modes as per sections 3 & 4 of this manual.
5. Secure control board (A) to surface box (C).
6. Clip facial plate (B) to control board (A).



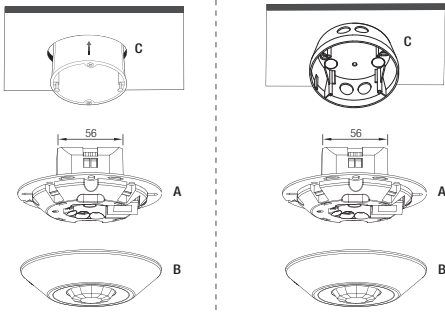

4. Sensor Mode Selection

Sensor mode can be easily selected by choosing the correct combination of the DIP switches (see table below):

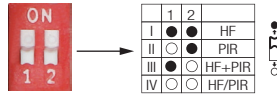

HF+PIR: Light is on when both HF and PIR sensors are activated.

HF/PIR: Light is on when HF or PIR sensors are activated.

5.3 Manual Override (Push Function)

With the help of push-switch, this sensor maybe over-riden by the end-users to switch on/off the lights manually, or adjust the target lux level. This makes the product more user-friendly and offers more options to fit for extra-ordinary demands.

* Short push (<1s): on/off function;

ON → OFF: the light turns off immediately and cannot be lightened for a certain time (equals to hold time preset) even movement is detected. After this period, the sensor goes back to auto sensor mode.

OFF → ON: the light turns on and goes to auto sensor mode.

* Long push (>1s): adjust the target lux level by turning the light up or down. Both the adjustment by remote control and push switch can overwrite each other, the last adjustment remains in memory.

5.4 Semi-auto Function (Absence Detection)

The motion sensor is employed, but only activated on the manual press of the push switch. With presence, the light remains on and can interact with ambient natural light, then dims down in absence, eventually switching off automatically after the stand-by time has expired.

Note: end-user can choose either function 5.3 or 5.4 for application. Default function is 5.3.

By connecting the "SYNC" terminals in parallel (see wiring diagram), no matter which sensor detects motion, all HIM14 in the group will turn on the lights when surrounding natural light is below the daylight threshold. The sensor module is shared and the detection area could be widely enlarged in this way.

6. Wiring Diagram

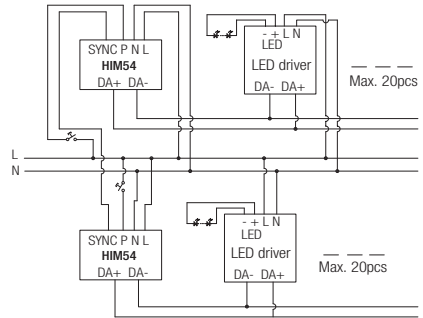

1. 200 metres (total) max. for 1mm² CSA (Ta = 50°C)
2. 300 metres (total) max. for 1.5mm² CSA (Ta = 50°C)

Note: if neither function 5.3 nor 5.4 is desired, simply leave the "push" terminal disconnected.

7. Detection Pattern

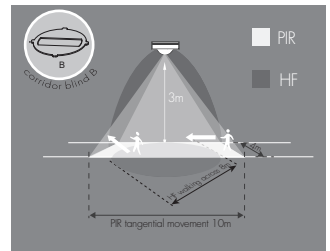
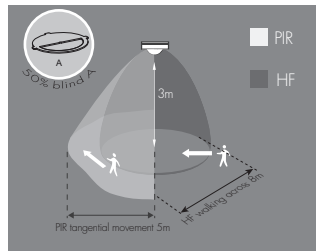
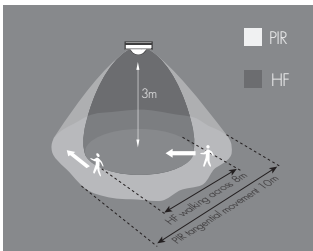
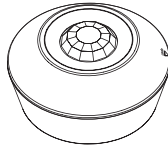

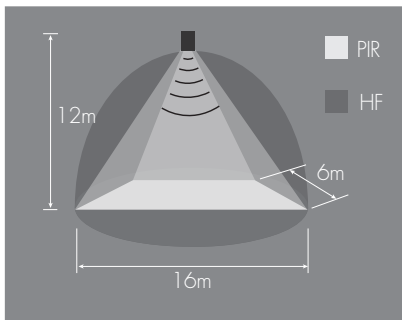
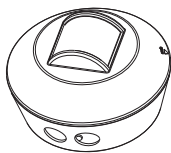

PIR detection: L x W x H: 16 x 6 x 12m (max.)

HF detection: H x D: 12 x 16m (max.)

8. Description of the Button Functions (remote control HRC-11)

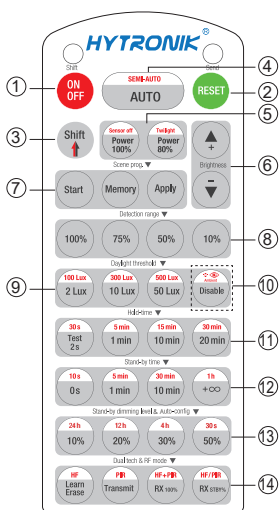

HRC-11

Permanent ON/OFF [button ①]

Press button ① to select permanent ON or permanent OFF mode.

* Press button ②/③ to resume automatic operation.
The mode will change to AUTO Mode after power failure.

RESET [button ②]

Press button ②, all settings go back to the rotary switch settings.
Sensor mode return to DIP switch settings.

Shift [button ③]

Press button ③, the LED on the top left corner flashes for indication.
All values / settings in RED are in valid for 20 seconds.

Auto Mode [button ④]

Press button ④ to initiate automatic mode. The sensor starts working and all settings remain as before the light was switched ON/OFF.

Semi-auto Mode [button ⑤ & ⑥]

1. Press button ⑤ Shift (the red LED flashes for indication),
2. press button ⑥ to initiate semi-auto mode. The fixture is manually on by push-switch and automatically off in semi-auto mode.

Power output [button ⑦]

Press button ⑦, the light output shifts between 80% and 100%.
Note: the function of "Sensor off" and "Twilight" are disabled.

Brightness +/- [button ⑧]

Press button ⑧ to adjust light brightness to reset the target lux level.

Scene prog. [zone ⑨] (One-key-commissioning)

1. Press button "Start" to program.
2. Select the buttons in ⑨ "Detection range", ⑩/⑪ "Daylight threshold", ⑫ "Hold time", ⑬ "Stand-by time", ⑭ "Stand-by dimming level" to set all parameters.
3. Press button "Memory" to save all the settings programmed in the remote control.
4. Press button "Apply" to set the settings to each sensor unit(s).
For example, to pre-set detection range 100%, daylight threshold Disable, hold time 5min, stand-by time +∞, stand-by dimming level 30%, steps should be:
Press button ⑨ Start, button ⑩ 100%, ⑪ Disable, ⑫ Shift, ⑬ 5min, ⑭ Shift, ⑮ +∞, ⑯ 30%, ⑰ Memory. By pointing to the sensor unit(s) and pressing ⑱ Apply, all settings are passed on the sensor(s).

Detection range [zone ⑩]

Press buttons in zone ⑩ to set HF detection range at 100% / 75% / 50% / 10%.

Daylight threshold [zone ⑪]

Press buttons in zone ⑪ to set the daylight sensor at 50Lux / 100Lux / 300Lux / 500Lux or Disable as threshold / target Lux level.
Note: 2Lux / 10Lux are disabled.

To set daylight sensor at 100Lux / 300Lux / 500Lux, press button ⑫ Shift at first.

Ambient daylight threshold [button ⑬]

1. Press button ⑬ Shift, the red LED flashes for indication.
2. Press button ⑬, the ambient lux level is sampled and set as daylight threshold / target Lux level.

Hold time [zone ⑫]

Press buttons in zone ⑫ to set the hold time at 2s / 30s / 1min / 5min / 10min / 15min / 20min / 30min.
Note: 1. To set hold-time at 30s / 5min / 15min / 30min, press button ⑬ Shift at first.

2. 2s is for test purpose only, stand-by time and daylight sensor settings are disabled in this mode.
* To exit from Test mode, press button ⑭ or any button in zone ⑩.

Stand-by time [zone ⑬]

Press buttons in zone ⑬ to set the stand-by time at 0s / 10s / 1min / 5min / 10min / 30min / 1h / +∞.

Note: "0s" means on/off control; "+∞" means bi-level control, 100% on when motion detected, and remains at the stand-by dimming level when no presence after hold-time.

Stand-by dimming level [zone ⑭]

Press buttons in zone ⑭ to set the stand-by dimming level at 10% / 20% / 30% / 50%.

Daylight harvest auto-configuration function

1. Press button "Shift", the red LED is on for indication.
2. Select a time period and the sensor will do light level measurement and determine/save the lowest light level (commission line) with 100% light on, so as to set the target lux level automatically.
Note: 1. Make sure the light level measurement covers the night time.
2. The fixture will go into sensor mode after the measurement, all sensor settings remain unchanged

Dual tech & RF mode [zone ⑰]

1. Press buttons in zone ⑰ to select sensor technology.
HF+PIR: Light is on when both HF and PIR sensors are activated.
HF/PIR: Light is on when HF or PIR sensors are activated.
2. Learn / Erase, Transmit, RX100% and RX STBY% are disabled.