

Tri-level Control HF Sensor

HC019V/I

Synchronised Control Version with Photocell Advance™

HYTRONIK®

Applications

Occupancy detector with tri-level control suitable for indoor use.







Suitable for building into the fixture:

- Office / Commercial Lighting
- Meeting room
- Classroom

Use for new luminaire designs and installations



Features

-  Special photocell to measure and differentiate natural light from LED light from behind the fixture cover
-  Tri-level dimming control based upon occupancy (also known as corridor function)
-  1-10V dimming control method
-  Synchronised dimming with multiple sensor circuits
-  Zero crossing detection circuit reduces in-rush current and prolongs relay life
-  Loop-in and loop-out terminal for efficient installation
-  5-Year Warranty

Technical Data

Input Characteristics

Model No.	HC019V/I
Mains voltage	220~240VAC 50/60Hz
Stand-by power	<0.8W
Load ratings:	
Capacitive	800VA
Resistive	2000W
Warming-up	20s

Safety and EMC

EMC standard (EMC)	EN55015, EN61000
Safety standard (LVD)	EN60669
Radio Equipment (RED)	EN300440, EN301489, EN62479
Certification	Semko, CB, CE, EMC, RED, RCM

Sensor Data

Model No.	HC019V/I
Sensor principle	High Frequency (microwave)
Operation frequency	5.8GHz +/- 75MHz
Transmission power	<0.2mW
Detection range	Max. (Ø x H) 12m x 6m
Detection angle	30° ~ 150°
Setting adjustments:	
Sensitivity	10% / 50% / 75% / 100%
Hold-time	5s ~ 30min (selectable)
Daylight threshold	2 ~ 50 lux, disabled
Stand-by period	0s ~ 1h, +∞ (selectable)
Stand-by dimming level	10% / 20% / 30% / 50%

Environment

Operation temperature	Ta: -35°C ~ +70°C
Case temperature (Max.)	Tc: +80°C
IP rating	IP20

CE  RED   CB IP20

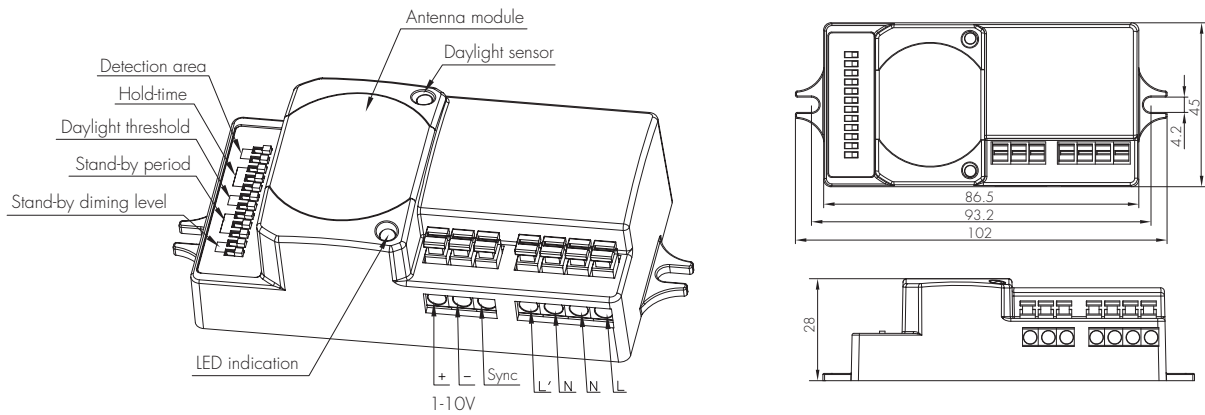

Note: We recommend the mounting distance between sensor to sensor should be more than 2m to prevent sensors from false-triggering.

Functions and Features

1 Photocell Advance™ Function

It's well known that LED lights have a totally different spectrum to natural light. Hytronik uses this principle and comes up with special photocell and sophisticated software algorithm to measure and differentiate natural light from LED light from behind the fixture cover, so that this photocell can ignore internal LED light and only respond to the natural light outside. Our technology has no infringement to the existing patents in the market.

Settings on this demonstration:

Hold-time: 10min

Daylight threshold: 50lux

Stand-by dimming level: 10%

Stand-by period: +∞



The light automatically turns on at dim level when natural light lux level drops below pre-set daylight threshold.

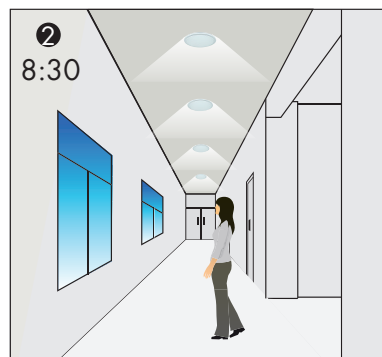

With insufficient natural light, the light switches on at 100% when there is motion detected.

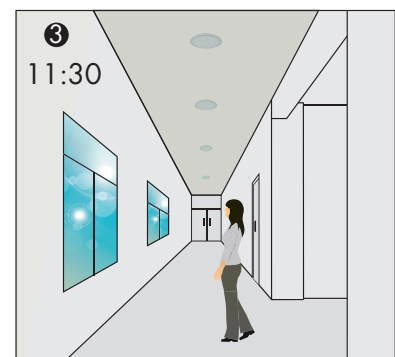

The light turns off completely whenever natural light reaches above pre-set daylight threshold, even with presence.

2 Synchronised Control

By connecting the "SYNC" terminals in parallel (maximum 10pcs, see wiring diagram), no matter which sensor detects motion, all HC019V/1 in the group will turn on the lights (ambient natural light is below daylight threshold). The sensor antennas are effectively 'shared' and the detection area is widely enlarged in this way.

Note: to avoid fixtures turning on unnecessarily, daylight sensing takes priority on a point-by-point basis. Occupancy sensing (sync) is disabled on those units in which the ambient light exceeds the daylight threshold.

With sufficient natural light, the lights does not switch on when presence detected.

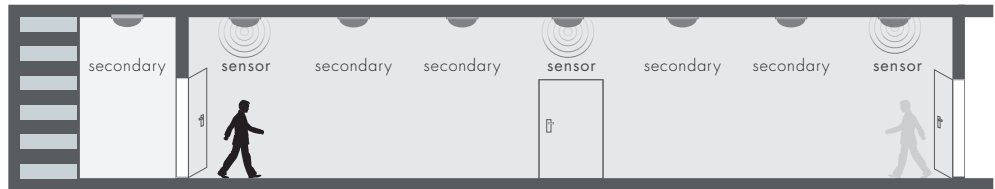

With insufficient natural light, the person comes from any direction, the whole group of lights switch on.

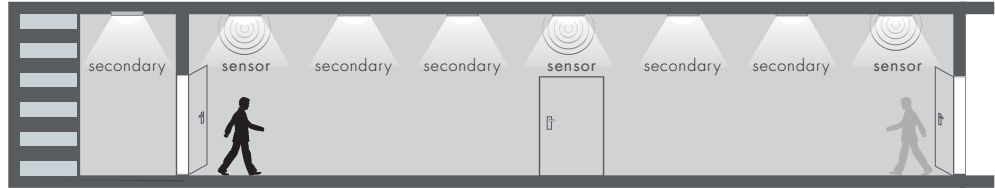

The lights dim to stand-by level after hold-time, or turn off completely if surrounding natural light is sufficient.

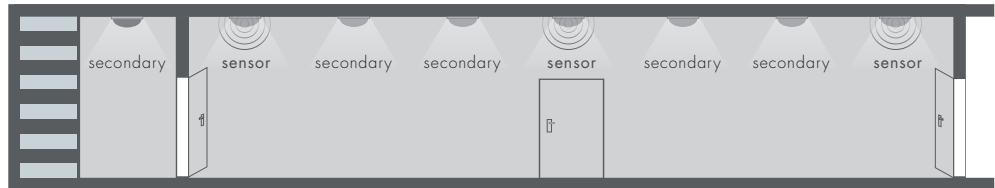

The lights switch off automatically after the stand-by period.

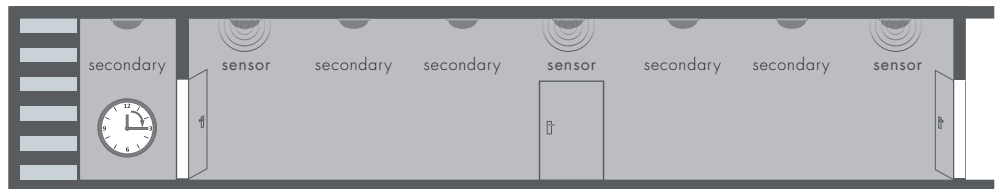

Multiple sensors control the same group of ballast /driver

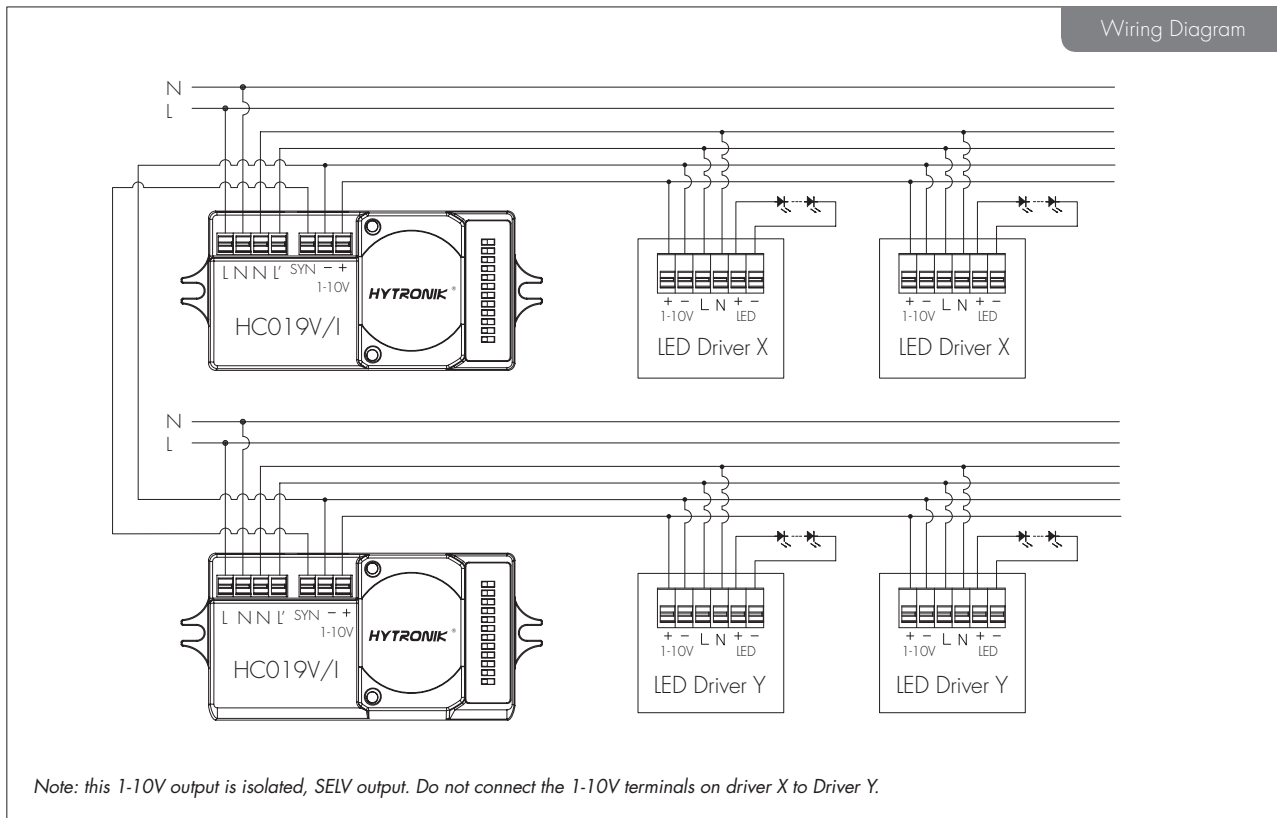

3 Tri-level Control (Corridor Function)

Hytronik builds this function inside the motion sensor to achieve tri-level control, for some areas that require a light change notice before switch-off. The sensor offers 3 levels of light: 100%-->dimmed light (natural light is insufficient) -->off; and 2 periods of selectable waiting time: motion hold-time and stand-by period; Selectable daylight threshold and freedom of detection area.

4 Zero-cross Relay Operation

Designed in the software, sensor switches on/off the load right at the zero-cross point, to ensure that the in-rush current is minimised, enabling the maximum lifetime of the relay.

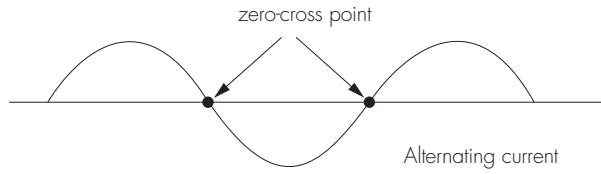

5 Loop-in and Loop-out Terminal

Double L N terminal makes it easy for wire loop-in and loop-out, and saves the cost of terminal block and assembly time.

One sensor controls a group of driver / ballast:

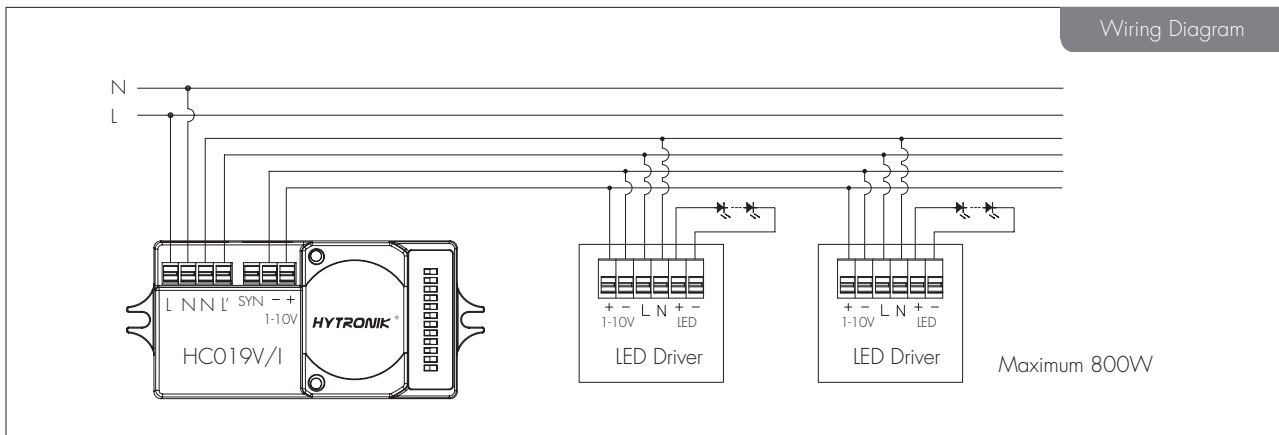

Detection Pattern

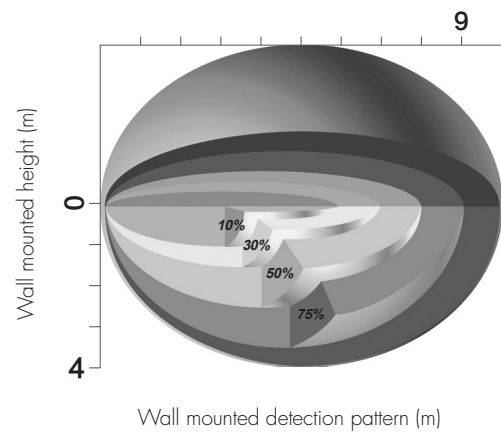
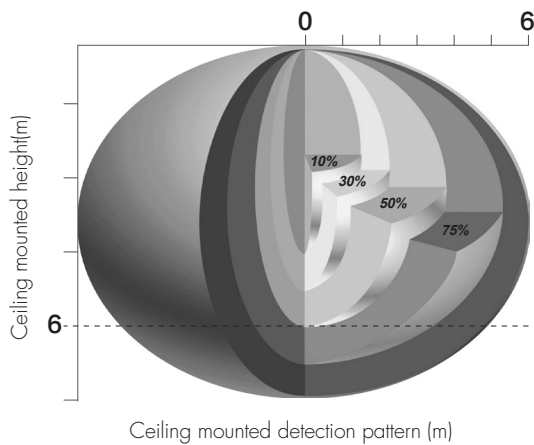

DIP Switch Settings

1 Detection Range

Sensor sensitivity can be adjusted by selecting the combination on the DIP switches to fit precisely for each specific application.

	1	2	
I	●	●	100%
II	●	○	75%
III	○	●	50%
IV	○	○	10%

I – 100%
II – 75%
III – 50%
IV – 10%

2 Hold Time

Select the dip switch configuration for the full brightness on-time after presence detection.

Please note that this function is disabled when the natural daylight exceeds the daylight threshold setting for more than 5 minutes.

	1	2	3	
I	●	●	●	5s
II	●	●	○	30s
III	●	○	●	1min
IV	●	○	○	5min
V	○	●	○	10min
VI	○	●	●	20min
VII	○	○	○	30min

I – 5s
II – 30s
III – 1min
IV – 5min
V – 10min
VI – 20min
VII – 30min

3 Daylight Threshold

Set the level according to the fixture and environment. In Photocell Advance™ mode this level will determine at which point the light turns off, and automatically turns back on again (stand-by time is set to infinity).

Please note that the levels refer to internal light reaching the sensor.

Disabling the daylight sensor will put the sensor into occupancy detection only mode.

	1	2	
I	●	●	Disable
II	●	○	50Lux
III	○	●	10Lux
IV	○	○	2Lux

I – Disable
II – 50Lux
III – 10Lux
IV – 2Lux

4 Stand-by period (corridor function)

This is the time period you would like to keep at the low light output level before it is completely switched off in the long absence of people.

Note: "0s" means on/off control;

"+ ∞" means the stand-by time is infinite and the fixture is effectively controlled by the daylight sensor, automatic on/off operation based upon daylight). Selecting other time periods will disable 'automatic on' operation and the photocell is used only to turn off the fixture automatically.

	1	2	3	
I	●	●	●	0s
II	●	●	○	10s
III	●	○	○	1min
IV	●	○	○	5min
V	○	●	○	10min
VI	○	●	●	30min
VII	○	○	●	1H
VIII	○	○	○	+∞

I – 0s
II – 10s
III – 1min
IV – 5min
V – 10min
VI – 30min
VII – 1H
VIII – +∞

5 Stand-by dimming level

The setting is used to select the desired dimmed light level used in periods of absence for enhanced comfort and safety.

	1	2	
I	●	●	10%
II	●	○	20%
III	○	●	30%
IV	○	○	50%

I – 10%
II – 20%
III – 30%
IV – 50%

Additional Information / Documents

- For full explanation of Hytronik Photocell Advance™ technology, please kindly refer to [www.hytronik.com/download ->knowledge ->Introduction of Photocell Advance](http://www.hytronik.com/download->knowledge->Introduction%20of%20Photocell%20Advance)
- Regarding precautions for microwave sensor installation and operation, please kindly refer to [www.hytronik.com/download ->knowledge ->Microwave Sensors - Precautions for Product Installation and Operation](http://www.hytronik.com/download->knowledge->Microwave%20Sensors%20-%20Precautions%20for%20Product%20Installation%20and%20Operation)
- Regarding Hytronik standard guarantee policy, please refer to [www.hytronik.com/download ->knowledge ->Hytronik Standard Guarantee Policy](http://www.hytronik.com/download->knowledge->Hytronik%20Standard%20Guarantee%20Policy)