

PIR Standalone Motion Sensor with Bluetooth® 5.0 SIG Mesh

HBHC25

Low-bay

HBHC25/R

Reinforced Low-bay

HBHC25/W

Wide range Low-bay

HBHC25/H

High-bay

HYTRONIK®



Product Description

HBHC25 is a Bluetooth PIR standalone motion sensor with 80mA DALI power supply built in, splitting into 2 DALI channels: 50mA for Channel 1 (up to 25 LED drivers) and 30mA (up to 15 LED drivers) for Channel 2. It is ideal for typical indoor applications such as office, classroom, healthcare and other commercial areas. With Bluetooth wireless mesh networking, it makes communication between luminaires much easier without time-consuming hardwiring, which eventually saves costs for projects (especially for retrofit upgrade projects!). Meanwhile, simple device setup and commissioning can be done via **Koolmesh®** app.



HBHC25



HBHC25/R



HBHC25/W



HBHC25/H

App Features

- Quick setup mode & advanced setup mode
- Tri-level control
- Daylight harvest
- Circadian rhythm (Human centric lighting)
- Floorplan feature to simplify project planning
- Web app/platform for dedicated project management
- Koolmesh Pro iPad version for on-site configuration
- Grouping luminaires via mesh network
- Scenes
- Detailed motion sensor settings
- Dusk/Dawn photocell (Twilight function)
- Push switch configuration
- Schedule to run scenes based on time and date
- Astro timer (sunrise and sunset)
- Staircase function (primary & secondary)
- Internet-of-Things (IoT) featured
- Device firmware update over-the-air (OTA)
- Device social relations check
- Bulk commissioning (copy and paste settings)
- Dynamic daylight harvest auto-adaptation
- Power-on status (memory against power loss)
- Offline commissioning
- Different permission levels via authority management
- Network sharing via QR code or keycode
- Remote control via gateway support HBGW01

- Interoperability with Hytronik Bluetooth product portfolio
- Compatible with EnOcean BLE switches
- Continuous development in progress...

Hardware Features

- 80mA DALI broadcast output in 2 channels:
 - 50mA (Channel 1)
 - 30mA (Channel 2)
- Support to control DT8 LED drivers
- 3 Push inputs for flexible manual control
- Keep real time for up to 3 months against power failure
- IP20/IP54 Ceiling/Surface mount box available as accessory
- Two types of blind inserts / blanking plates
- User-friendly design for installation
- High bay version available (up to 20m in height)
- 5-year warranty

Bluetooth® Kinetic Switch



HBKS01



HBKS02



HBKS03



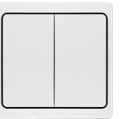

HBKS01D





HBKS02D













EnOcean
Self-powered IoT

Fully support EnOcean self-powered switch module
PTM215B (HBES01/W & HBES01/B)

Bluetooth® 5.0 SIG mesh







iOS



Android





for iOS



for Android

Smartphone app for both iOS & Android platform





for iPad

Koolmesh Pro app for iPad

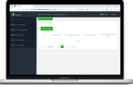



Web



for Web

Web app/platform: www.iot.koolmesh.com

Technical Specifications

Bluetooth Transceiver	
Operation frequency	2.4 GHz - 2.483 GHz
Transmission power	4 dBm
Range (Typical indoor)	10~30m
Protocol	 Bluetooth® 5.0 SIG Mesh

Sensor Data	
Sensor Model	PIR max* detection range
HBHC25	Installation Height : 6m Detection Range(Ø) : 9m
HBHC25/R	Installation Height : 6m Detection Range(Ø) : 10m
HBHC25/W	Installation Height : 6m Detection Range(Ø) : 18m
HBHC25/H	Installation height: 1.5m (forklift) 1.2m (person) Detection range (Ø): 24m
Detection angle	360°

* For more details of detection range, please refer to "detection pattern" section.

Input & Output Characteristics	
Operating voltage	220~240VAC 50/60Hz
Stand-by power	<1W
DALI Channel 1	50mA, Max. 25 devices
DALI Channel 2	30mA, Max. 15 devices

* Suitable for DALI DT8 LED drivers

Safety & EMC	
EMC standard (EMC)	EN55015, EN61000, EN61547
Safety standard (LVD)	EN60669-1/-2-1 AS/NZS60669-1/-2-1
RED	EN300328, EN301489-1/-17
Certification	CB, CE, EMC, RED, RCM

Environment	
Operation temperature	Ta: -20°C ~ +50°C
IP rating	IP20
IP rating (facial part)	IP54

* IP54 (facial part) only for lens of standard, /R, /H

Mechanical Structure & Dimensions

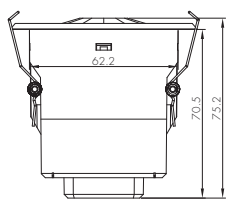
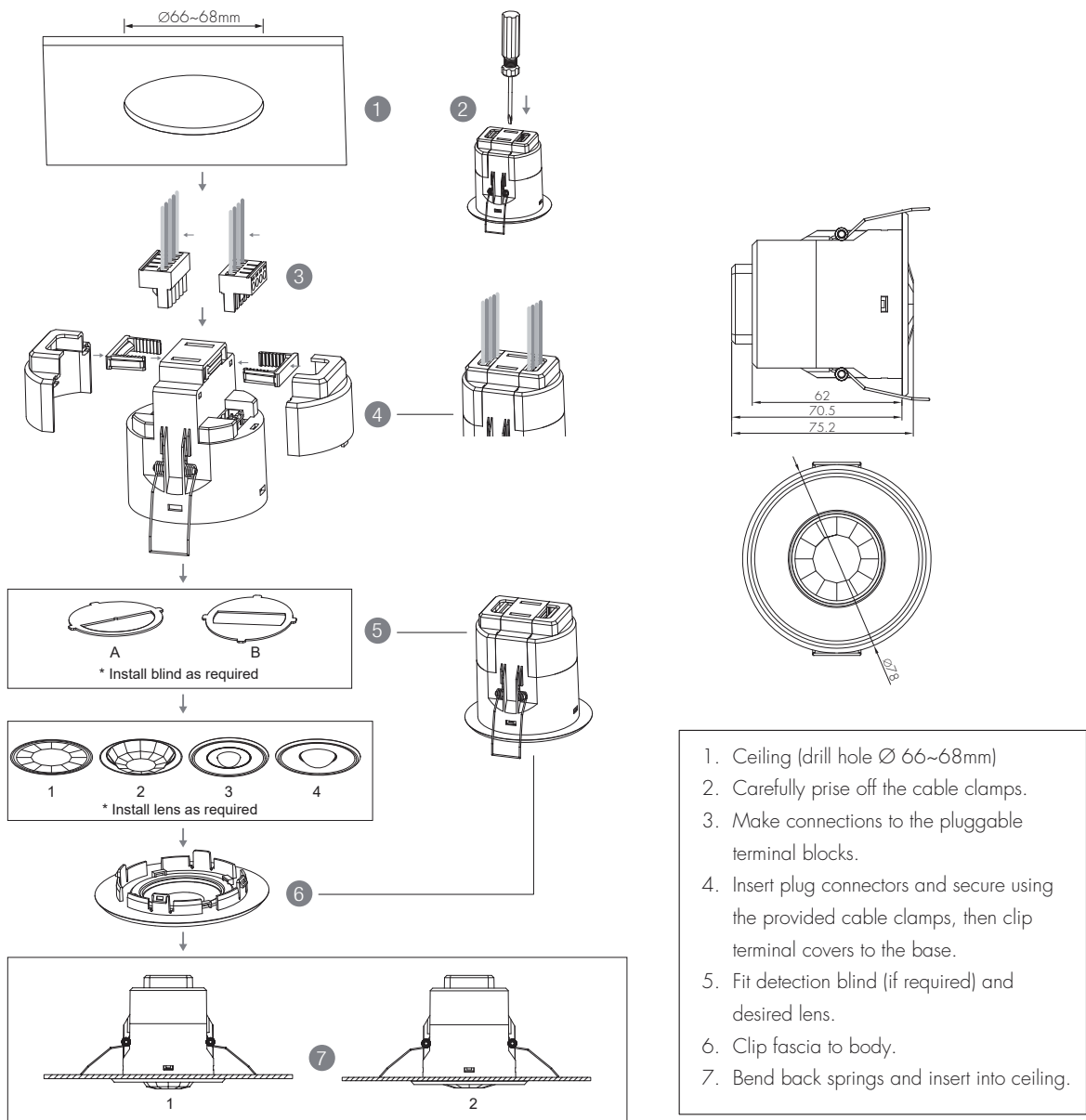

HBHC25

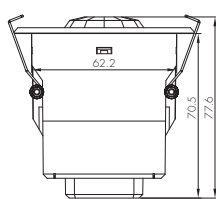

HBHC25/R

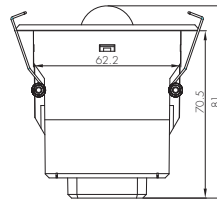

HBHC25/W

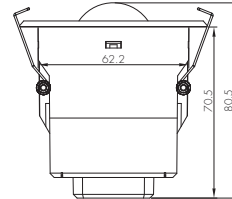

HBHC25/H

Wiring Diagram

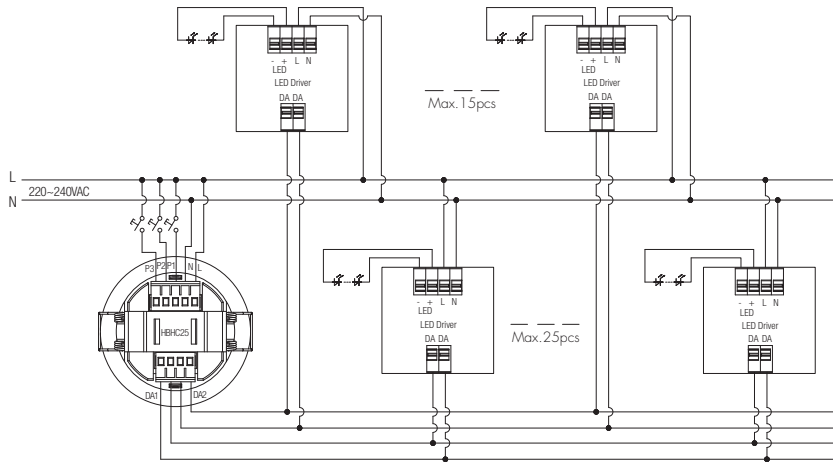

Wire Preparation



0.75 - 2.5mm²

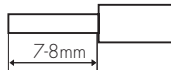

Pluggable screw terminal. It is recommended to make connections to the terminal before fitting to the sensor.

1. 200 metres (total) max. for 1mm² CSA (Ta = 50°C)
2. 300 metres (total) max. for 1.5mm² CSA (Ta = 50°C)

Detection Pattern & Optional Accessories

Placement Guide and Typical Range

Smart Phone to Device Range



The smart device with the App installed will have a typical range of 10m, but varies from device to device. During commissioning, the installer will need to be in range of the devices when searching for devices to add to the network.

Once the devices have been added to the network via the App, the devices will start communicating within the wireless mesh. This means that once the network is complete, all devices are accessible from the smart device when in a 20m range of a single point.

Big and small silicon gasket used to make IP54 degree protection (mounted into HA09 housing for ceiling mount)

Small silicon water-proof gasket dimension(size:mm)

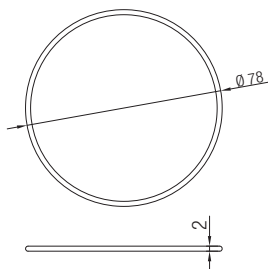

Big silicon water-proof gasket dimension(size:mm)

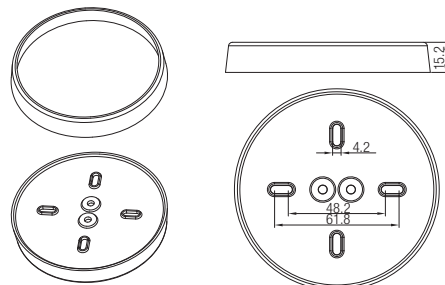

Note: The small silicon water-proof gasket is not suitable for HBHC25/W
The Big silicon water-proof gasket is not suitable for HBHC25/W

1. HBHC25 (Low-bay)



HBHC25: Low-bay flat lens detection pattern for single person @ Ta = 20°C
 (Recommended ceiling mount installation height **2.5m-6m**)

A: Tangential movement

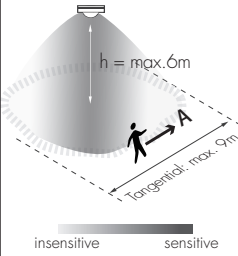

B: Radial movement

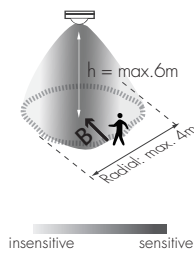

Mount height	Tangential (A)	Radial (B)
2.5m	max 50m ² (Ø = 8m)	max 13m ² (Ø = 4m)
3m	max 64m ² (Ø = 9m)	max 13m ² (Ø = 4m)
4m	max 38m ² (Ø = 7m)	max 13m ² (Ø = 4m)
5m	max 38m ² (Ø = 7m)	max 13m ² (Ø = 4m)
6m	max 38m ² (Ø = 7m)	max 13m ² (Ø = 4m)

Optional Accessory --- Ceiling/Surface Metal Mount Box: HA09/W, HA09/B, HA09/G

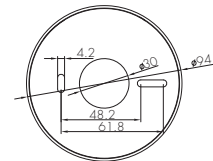
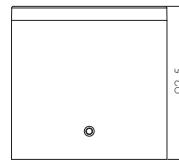

Optional Accessory --- Blind Insert for Blocking Certain Detection Angles

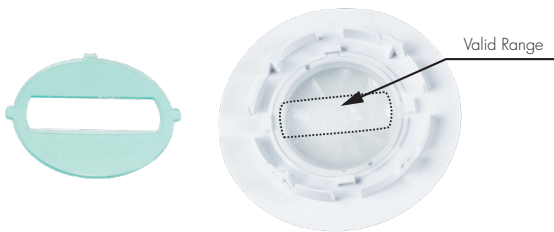

Blind Option 1 --- Aisle Detection

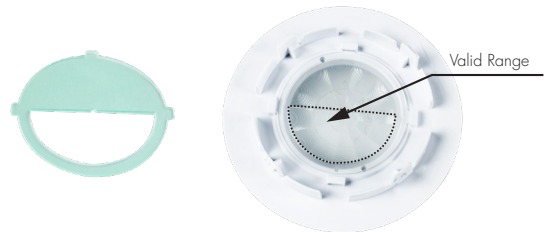

Blind Option 2 --- 180° Detection

2. HBHC25/R (Reinforced Low-bay)



HBHC25/R: Low-bay convex lens detection pattern for **single person** @ Ta = 20°C

(Recommended ceiling mount installation height **2.5m-6m**)

A: Tangential movement	B: Radial movement	Mount height	Tangential (A)	Radial (B)
		2.5m	max 79m ² (Ø = 10m)	max 20m ² (Ø = 5m)
		3m	max 79m ² (Ø = 10m)	max 20m ² (Ø = 5m)
		4m	max 64m ² (Ø = 9m)	max 20m ² (Ø = 5m)
		5m	max 50m ² (Ø = 8m)	max 20m ² (Ø = 5m)
		6m	max 50m ² (Ø = 8m)	max 20m ² (Ø = 5m)

Optional Accessory --- Ceiling/Surface Metal Mount Box: HA09/W, HA09/B, HA09/G

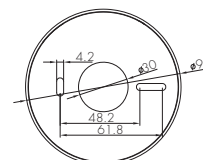
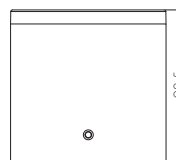

Optional Accessory --- Blind Insert for Blocking Certain Detection Angles

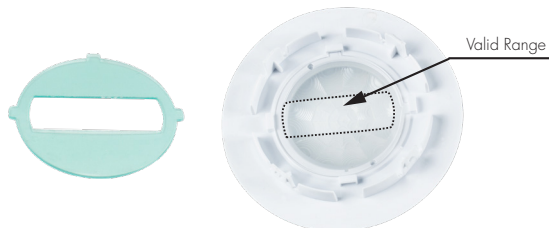

Blind Option 1 --- Aisle Detection

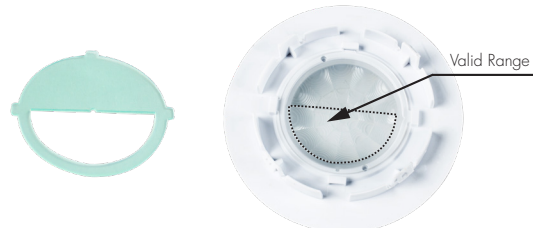

Blind Option 2 --- 180° Detection

3. HBHC25/W (Wide range Low-bay)



HBHC25/W: Low-bay convex lens detection pattern for **single person** @ $T_a = 20^\circ\text{C}$

(Recommended ceiling mount installation height **2.5m-6m**)

A: Tangential movement	B: Radial movement	Mount height	Tangential (A)	Radial (B)
		2.5m	max 254m ² (Ø = 18m)	max 28m ² (Ø = 6m)
		3m	max 254m ² (Ø = 18m)	max 28m ² (Ø = 6m)
		4m	max 154m ² (Ø = 14m)	max 28m ² (Ø = 6m)
		5m	max 113m ² (Ø = 12m)	max 28m ² (Ø = 6m)
		6m	max 79m ² (Ø = 10m)	max 13m ² (Ø = 4m)

Optional Accessory -- Ceiling/Surface Metal Mount Box: HA09/W, HA09/B, HA09/G

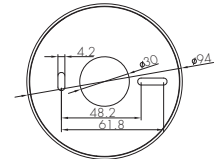
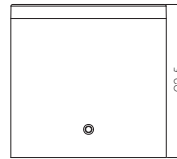
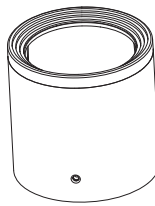

4. HBHC25/H (High-bay)



HBHC25/H: High-bay lens detection pattern for forklift @ $T_a = 20^\circ\text{C}$

(Recommended ceiling mount installation height **10m-15m**)

A: Tangential movement

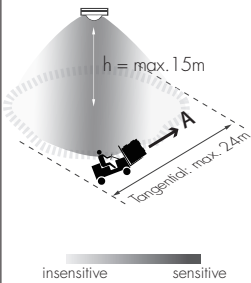

B: Radial movement

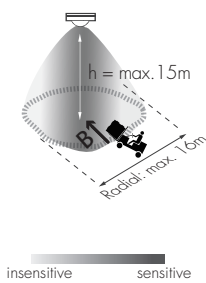

Mount height

Tangential (A)

Radial (B)

10m

max 380m² (Ø = 22m)

max 201m² (Ø = 16m)

11m

max 452m² (Ø = 24m)

max 201m² (Ø = 16m)

12m

max 452m² (Ø = 24m)

max 201m² (Ø = 16m)

13m

max 452m² (Ø = 24m)

max 177m² (Ø = 15m)

14m

max 452m² (Ø = 24m)

max 133m² (Ø = 13m)

15m

max 452m² (Ø = 24m)

max 113m² (Ø = 12m)



HBHC25/H: High-bay lens detection pattern for single person @ $T_a = 20^\circ\text{C}$

(Recommended ceiling mount installation height **2.5m-12m**)

A: Tangential movement

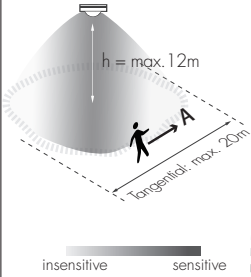

B: Radial movement

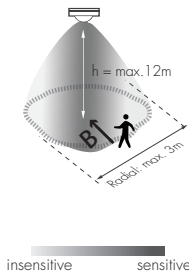

Mount height

Tangential (A)

Radial (B)

2.5m

max 50m² (Ø = 8m)

max 7m² (Ø = 3m)

6m

max 104m² (Ø = 11.5m)

max 7m² (Ø = 3m)

8m

max 154m² (Ø = 14m)

max 7m² (Ø = 3m)

10m

max 227m² (Ø = 17m)

max 7m² (Ø = 3m)

11m

max 269m² (Ø = 18.5m)

max 7m² (Ø = 3m)

12m

max 314m² (Ø = 20m)

max 7m² (Ø = 3m)

Optional Accessory --- Ceiling/Surface Metal Mount Box: HA09/W, HA09/B, HA09/G

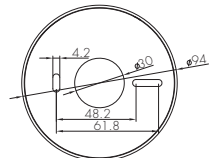
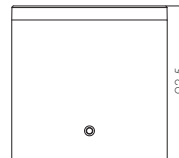

Optional Accessory --- Blind Insert for Blocking Certain Detection Angles

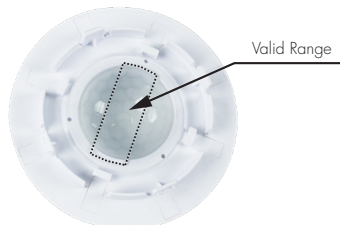



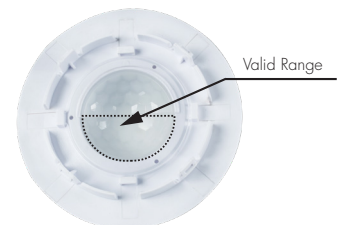





Blind Option 1 --- Aisle Detection



Blind Option 2 --- 180° Detection

Typical Application for Classroom (Human Centric Lighting)

Different from other complex system, Hytronik offer a simple yet decentralized one-stop solution to achieve Human Centric lighting. It cuts at least 50% to 60% in costs as compared to traditional complex wiring system. This solution is based on Bluetooth together with an intuitive and portable app; it does not require complicated PC tools to set up and configure. What's more, our Bluetooth solution is futureproof with OTA upgrade capability. With services of tailor making Bluetooth solution including app, products, server and cloud, this solution brings flexibility and versatility to adapt to each customer's requirements at affordable prices.

	What you need	What you get
	HBHC25 x 1	<ul style="list-style-type: none"> Bluetooth enabled and controllable via app 2 DALI channels for whiteboard/electronic display area and student area independently Human Centric Function PIR motion sensing Daylight Harvest
	Push switches x 3	<ul style="list-style-type: none"> Manual control: brightness adjustment, colour tuning, recall scenes etc.
	HHC2045 x 8 for LED panels HHC2050L x 4 for linear LED lights	<ul style="list-style-type: none"> Tunable white LED driver (Can also be any other DALI DT8 drivers)
	HBPO2 x 1 (Optional)	<ul style="list-style-type: none"> Bluetooth touch panel Can recall up to 6 scenes Switchable between each scene Brightness adjustment, colour tuning
	QCBO1 x 2 with cables and plugs (Optional)	<ul style="list-style-type: none"> Labour cost saved significantly Hassle-free maintenance after installation Simplify wiring on site via plug 'n' play
	HBGW01 gateway x 1 (Optional)	<ul style="list-style-type: none"> Remote control access Data collection and analysis
	Free app	<ul style="list-style-type: none"> Futureproof via OTA Off-line commissioning
	Cloud & server	<ul style="list-style-type: none"> Settings data backup Accounts security

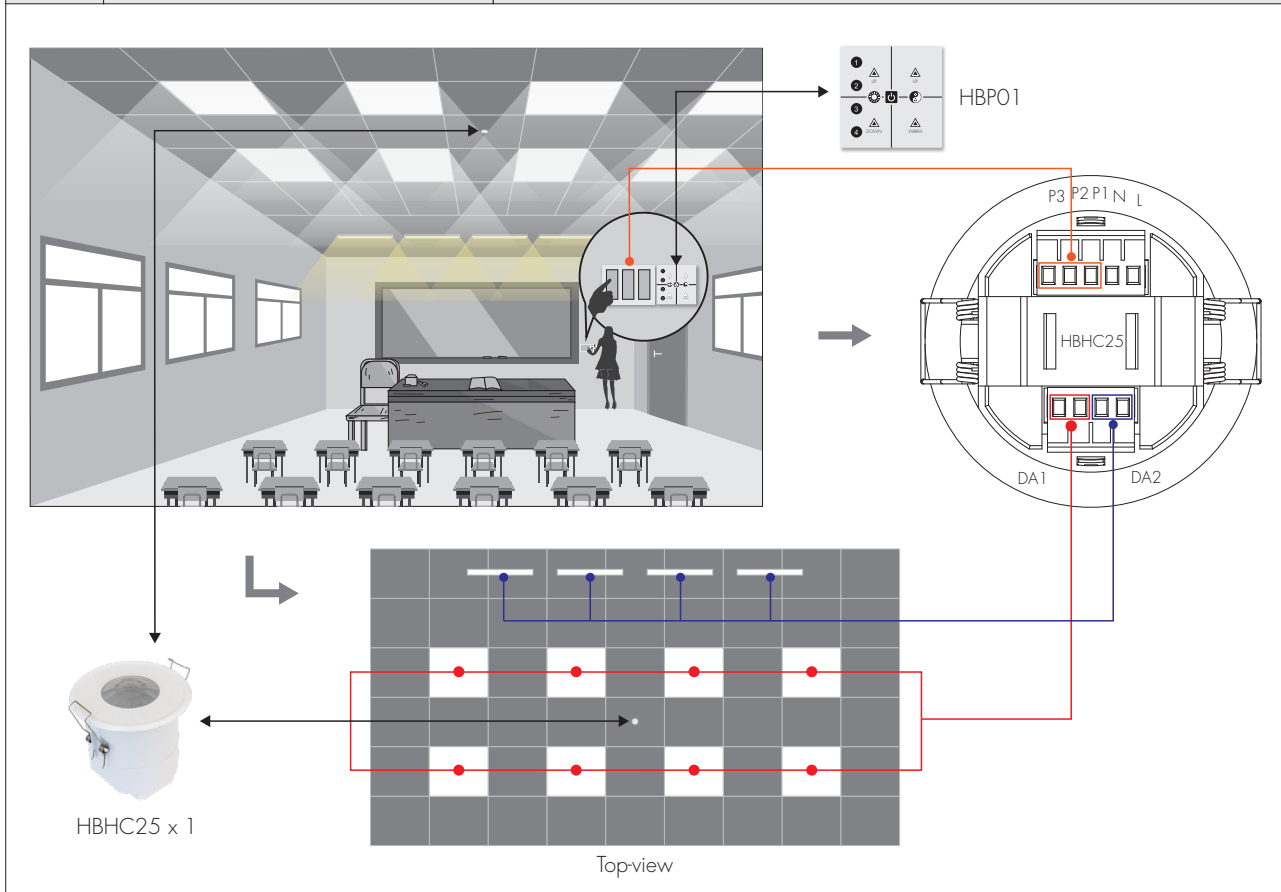

Dimming Interface Operation Notes

Switch-Dim

The provided Switch-Dim interface allows for a simple dimming method using commercially available non-latching (momentary) wall switches. Detailed Push switch configurations can be set on Koolmesh app.

Switch Function	Action	Descriptions
Push switch	Short press (<1 second) * Short press has to be longer than 0.1s, or it will be invalid.	- Turn on/off - Turn on only - Turn off only - Recall a scene - Quit manual mode - Do nothing
	Double push	- Turn on only - Turn off only - Recall a scene - Quit manual mode - Do nothing
	Long press (≥ 1 second)	- Dimming - Colour tuning - Do nothing
Sensor-link	/	- Upgrade a normal on/off motion sensor to a Bluetooth controlled motion sensor
Emergency Self-Test Function	Short press (<1 second) * Short press has to be longer than 0.1s, or it will be invalid.	- Start Self test (Monthly) - Stop Self test - Start Self test (Annually) - Invalid
	Long press (≥ 1 second)	- Start Self test (Monthly) - Stop Self test - Start Self test (Annually) - Invalid
Fire Alarm (VFC signal only)	Refer to Koolmesh ® App User Manual V2.1	- Able to connect the Fire Alarm system - Once the fire alarm system is triggered, all the luminaries controlled by the Push Switch will enter the preset scene (normally it's full on), after the fire alarm system gives the ending signal, all the luminaries controlled by this Push Switch will revert back to normal status.

Additional Information / Documents

- To learn more about detailed product features/functions, please refer to [www.hytronik.com/download ->knowledge ->Introduction of App Scenes and Product Functions](http://www.hytronik.com/download->knowledge->Introduction of App Scenes and Product Functions)
- Regarding precautions for Bluetooth product installation and operation, please kindly refer to [www.hytronik.com/download ->knowledge ->Bluetooth Products - Precautions for Product Installation and Operation](http://www.hytronik.com/download->knowledge->Bluetooth Products - Precautions for Product Installation and Operation)
- Regarding precautions for PIR Sensors installation and operation, please kindly refer to [www.hytronik.com/download ->knowledge ->PIR Sensors - Precautions for Product Installation and Operation](http://www.hytronik.com/download->knowledge->PIR Sensors - Precautions for Product Installation and Operation)
- Data sheet is subject to change without notice. Please always refer to the most recent release on www.hytronik.com/products/bluetooth technology ->Bluetooth Sensors
- Regarding Hytronik standard guarantee policy, please refer to [www.hytronik.com/download ->knowledge ->Hytronik Standard Guarantee Policy](http://www.hytronik.com/download->knowledge->Hytronik Standard Guarantee Policy)