

Bluetooth® 5.0 PIR Motion Sensor Compatible with Zhaga Book 20 Standard

HIR60

Low bay

HIR60/R

Mid bay with IP54

HYTRONIK®



Product Description

HIR60 & HIR60/R are Bluetooth 5.0 SIG mesh PIR motion sensors, designed with Zhaga standard D4i (Book 20 connection) that enables lighting designers/manufactures to freely connect to Zhaga Book 20 standard LED Drivers via plug'n'play. It's embedded with Bluetooth module, PIR sensor and also a daylight sensor, and yet comes with a surprisingly super-mini size! With Bluetooth wireless mesh networking, it makes communication between luminaires much easier without time-consuming hardwiring, which is always a headache especially for old buildings – you do not need any extra wirings to upgrade old buildings with smart lighting! Meanwhile, simple device setup and commissioning can be done via **Koolmesh™** app.



HIR60



HIR60/R

App Features

- Quick setup mode & advanced setup mode
- Tri-level control
- Daylight harvest
- Circadian rhythm (Human centric lighting)
- Floorplan feature to simplify project planning
- Web app/platform for dedicated project management
- Koolmesh Pro iPad version for on-site configuration
- Grouping luminaires via mesh network
- Scenes
- Detailed motion sensor settings
- Dusk/Dawn photocell (Twilight function)
- Schedule to run scenes based on time and date
- Astro timer (sunrise and sunset)
- Staircase function (primary & secondary)
- Compatible with EnOcean BLE switches
- Internet-of-Things (IoT) featured
- Device firmware update over-the-air (OTA)
- Device social relations check
- Bulk commissioning (copy and paste settings)
- Dynamic daylight harvest auto-adaptation
- Power-on status (memory against power loss)
- Offline commissioning
- Different permission levels via authority management
- Network sharing via QR code or keycode
- Remote control via gateway support HBGW01
- Interoperability with Hytronik Bluetooth product portfolio
- Continuous development in progress...

Hardware Features

- 5-in-1: Bluetooth 5.0 + Zhaga standard + D4i + PIR motion sensor + Daylight sensor
- Optional accessories for different mounting style
- IP65 rated design for HIR60/R facia/lens part
- Super compact mini size
- Plug'n'Play via Zhaga Book 20 connection standard
- 5-year warranty
- coming soon...
- coming soon...

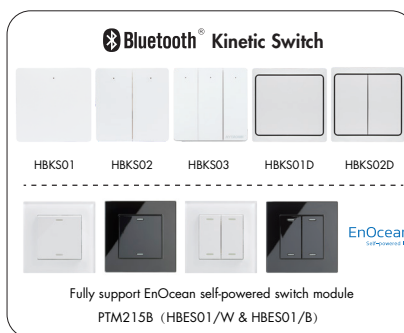

Technical Specifications

Bluetooth Transceiver	
Operation frequency	2.4 GHz - 2.483 GHz
Transmission power	4 dBm
Range (Typical indoor)	10~30m
Protocol	 Bluetooth® 5.0 SIG Mesh

Environment	
Operation temperature	Ta: -20°C ~ 50°C
Storage temperature	-40°C ~ +70°C
Relative humidity	10 ~ 90%
IP rating	IP20

PIR Sensor Properties (HIR60 & HIR60/R)	
Sensor principle	PIR detection
Operation voltage	9.5~22.5VDC
Input current	Approx. 30mA
Detection range *	HIR60 Max installation height: 3m Max detection range (Ø): 12m
	HIR60/R Max installation height: 8m (for person) Max installation height: 12m (for forklift) Max detection range (Ø): 20m
Detection angle	360°

* The detection range is heavily influenced by sensor placement (angle) and different walking paces. It may be reduced under certain conditions.

Optional Accessories



* Default: white housing, black version can be requested.

Demonstration of installation for transparent version

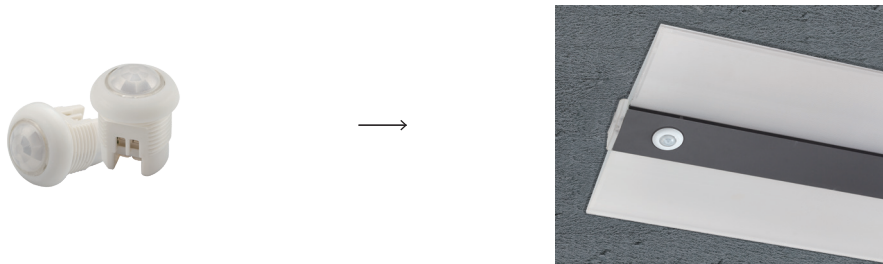

Mechanical Structure & Dimensions

HIR60

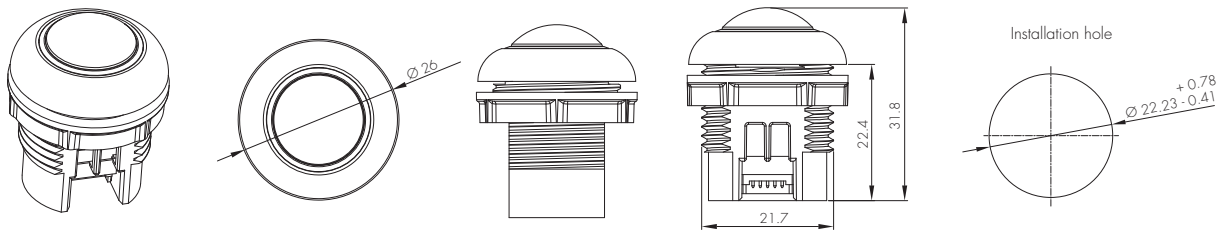

HIR60 with HA04

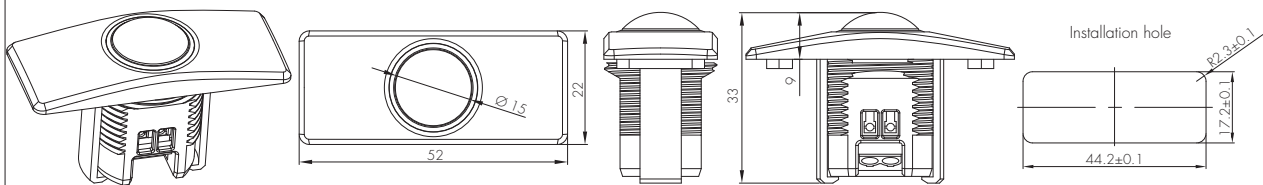

Note: We suggest that the metal plate thickness to be 0.8mm – 1.6mm to ensure perfect focal length for the PIR lens.

HIR60 with HA05

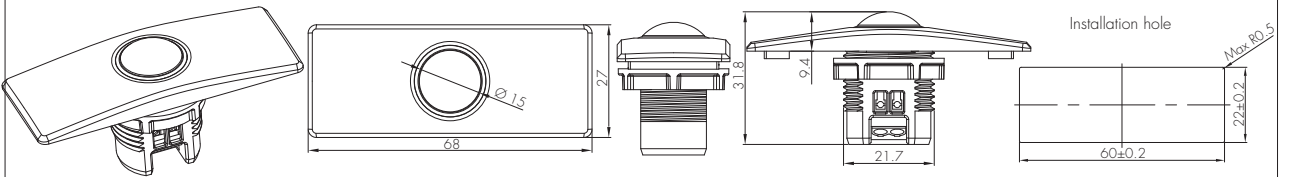

HIR60 with HA10

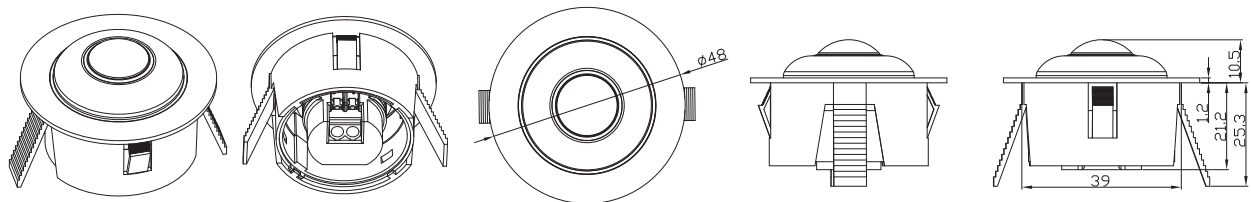

HIR60/R (IP54)

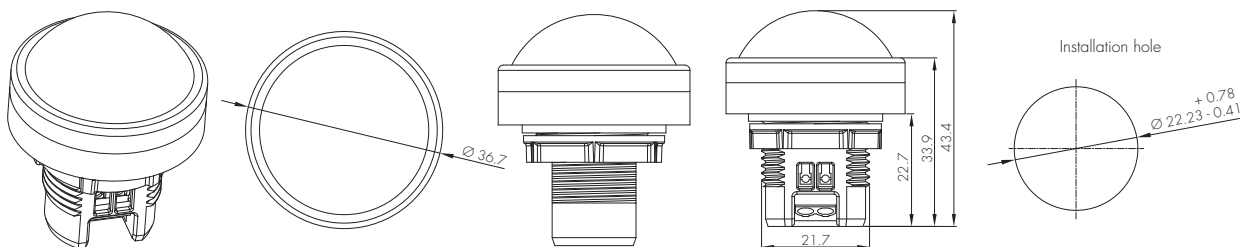

Wire Preparation



To make or release the wire from the terminal, use a screwdriver to push down the button.

1.100 metres (total) max. for 0.5mm² CSA (Ta = 50°C)

2.150 metres (total) max. for 0.75mm² CSA (Ta = 50°C)

Wiring Diagram

DAI Driver

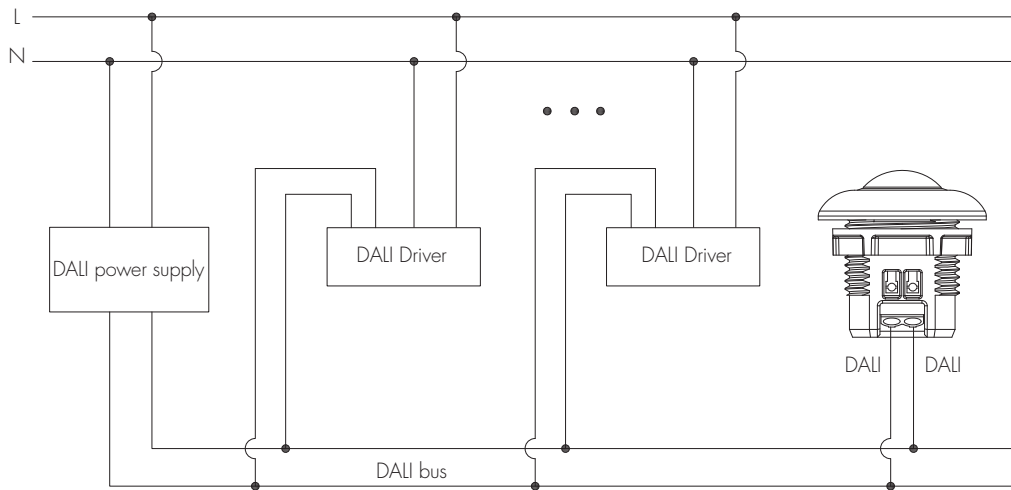

Detection Pattern - - Diagram 1

The data below is tested under following conditions:

- Single person walking;
- Sensor not connected to any driver that may have soft-on period;
- Testing temperature Ta = 20°C;
- The testing is conducted in an open and spacious indoor field, without noticeable obstacles or influences that may affect PIR performances.



HIR60

A: Tangential movement

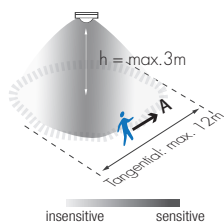

B: Radial movement

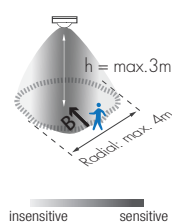

Mount height	Tangential Movement (A)	Radial Movement (B)
3m	max 113m ² (Ø = 12m)	max 12m ² (Ø = 4m)

Detection Pattern -- Diagram 2

The data below is tested under following conditions:

- Forklift driving at a speed of 10km/h;
- Sensor not connected to any driver that may have soft-on period;
- Testing temperature $T_a = 20^\circ\text{C}$;
- The testing is conducted in an open and spacious indoor field, without noticeable obstacles or influences that may affect PIR performances.



HIR60/R

A: Tangential movement

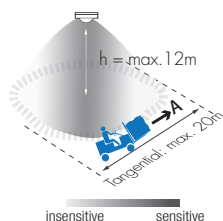

B: Radial movement

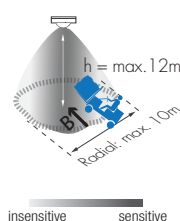

Mount height	Tangential Movement (A)	Radial Movement (B)
8m	max 201m ² (Ø = 16m)	max 50m ² (Ø = 8m)
9m	max 227m ² (Ø = 17m)	max 50m ² (Ø = 8m)
10m	max 254m ² (Ø = 18m)	max 63m ² (Ø = 9m)
11m	max 314m ² (Ø = 20m)	max 78m ² (Ø = 10m)
12m	max 314m ² (Ø = 20m)	max 78m ² (Ø = 10m)

Detection Pattern -- Diagram 3

The data below is tested under following conditions:

- Single person walking;
- Sensor not connected to any driver that may have soft-on period;
- Testing temperature $T_a = 20^\circ\text{C}$;
- The testing is conducted in an open and spacious indoor field, without noticeable obstacles or influences that may affect PIR performances.



HIR60/R

A: Tangential movement

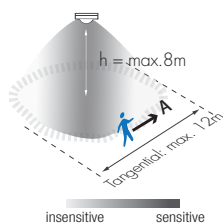

B: Radial movement

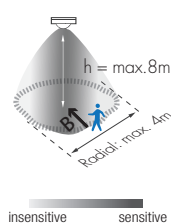

Mount height	Tangential Movement (A)	Radial Movement (B)
3m	max 38m ² (Ø = 7m)	max 7m ² (Ø = 3m)
4m	max 50m ² (Ø = 8m)	max 7m ² (Ø = 3m)
5m	max 50m ² (Ø = 8m)	max 7m ² (Ø = 3m)
6m	max 64m ² (Ø = 9m)	max 12m ² (Ø = 4m)
7m	max 95m ² (Ø = 11m)	max 12m ² (Ø = 4m)
8m	max 113m ² (Ø = 12m)	max 12m ² (Ø = 4m)

Smart Phone to Device Range

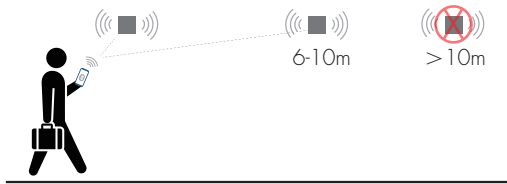

The smart device with the App installed will have a typical range of 10m, but varies from device to device. During commissioning, the installer will need to be in range of the devices when searching for devices to add to the network.

Once the devices have been added to the network via the App, the devices will start communicating within the wireless mesh. This means that once the network is complete, all devices are accessible from the smart device when in a 20m range of a single point.

Additional Information / Documents

1. To learn more about detailed product features/functions, please refer to www.hytronik.com/download ->knowledge ->Introduction of App Scenes and Product Functions
2. Regarding precautions for Bluetooth product installation and operation, please kindly refer to www.hytronik.com/download ->knowledge ->Bluetooth Products - Precautions for Product Installation and Operation
3. Regarding precautions for PIR Sensors installation and operation, please kindly refer to www.hytronik.com/download ->knowledge ->PIR Sensors - Precautions for Product Installation and Operation
4. Data sheet is subject to change without notice. Please always refer to the most recent release on www.hytronik.com/products/bluetooth-technology ->Bluetooth Sensors
5. Regarding Hytronik standard guarantee policy, please refer to www.hytronik.com/download ->knowledge ->Hytronik Standard Guarantee Policy