

Flush Mount PIR Motion Sensor



HYTRONIK®

CE emc CB IP40

HIR32
Low-bay

HIR32/R
Reinforced Low-bay

HIR32/H
High-bay

Applications

Office, classroom and commercial interior spaces where DALI control is required in small groups.

- Office / Commercial Lighting
- Classrooms
- Stairwells / Corridors



HIR32



HIR32/R



HIR32/H

HIR32 with DALI Broadcast Output

Designed with a low profile for aesthetically demanding architectural projects whilst retaining the functionality expected of the latest lighting controls. Control to the light fixtures is provided via self-powered DALI communication (up to 40 drivers).

Set-up of the sensor is carried out using a remote control handset with program memory allowing one-key commissioning where common settings are used for multiple devices.

Features

- DALI dimming control based upon occupancy.
- Daylight harvest function to regulate light output for maintaining required lux level.
- Store settings in the remote for easy commissioning when programming multiple sensors.
- Intelligent photocell - lights and sensors only operate when needed, natural light has priority.
- Black & White & Gray metal surface mount box option
- Two types of blind inserts / blanking plates
- User-friendly design for installation
- High bay version available (up to 15m in height)
- 5-year warranty

Technical Data

Input Characteristics	
Operating voltage	220-240VAC 50/60Hz
Stand-by power	<0.5W

Safety and EMC	
EMC standard (EMC)	EN55015, EN61000
Safety standard (LVD)	EN60669, AS/NZS60669
Certification	CB, CE, EMC, RCM

Output Characteristics	
DALI Channel 1	50mA, Max.
DALI Channel 2	30mA, Max.

Suitable for DALI DT8 LED drivers

PIR Sensor Data	
Warm-up Period	Approximately 20s
Detection range (Max.)* HIR32	Installation Height : 6m Detection Range(Ø) : 9m
Detection range (Max.)* HIR32/R	Installation Height : 6m Detection Range(Ø) : 10m
Detection range (Max.)* HIR32/H	Installation height: 1.5m (forklift) 12m (person) Detection range (Ø): 24m
Detection angle	360°

* For more details of detection range, please refer to "detection pattern" section.

Environment	
Operation temperature	Ta: -20°C ~ +50°C
IP rating	IP20

Mechanical Structure

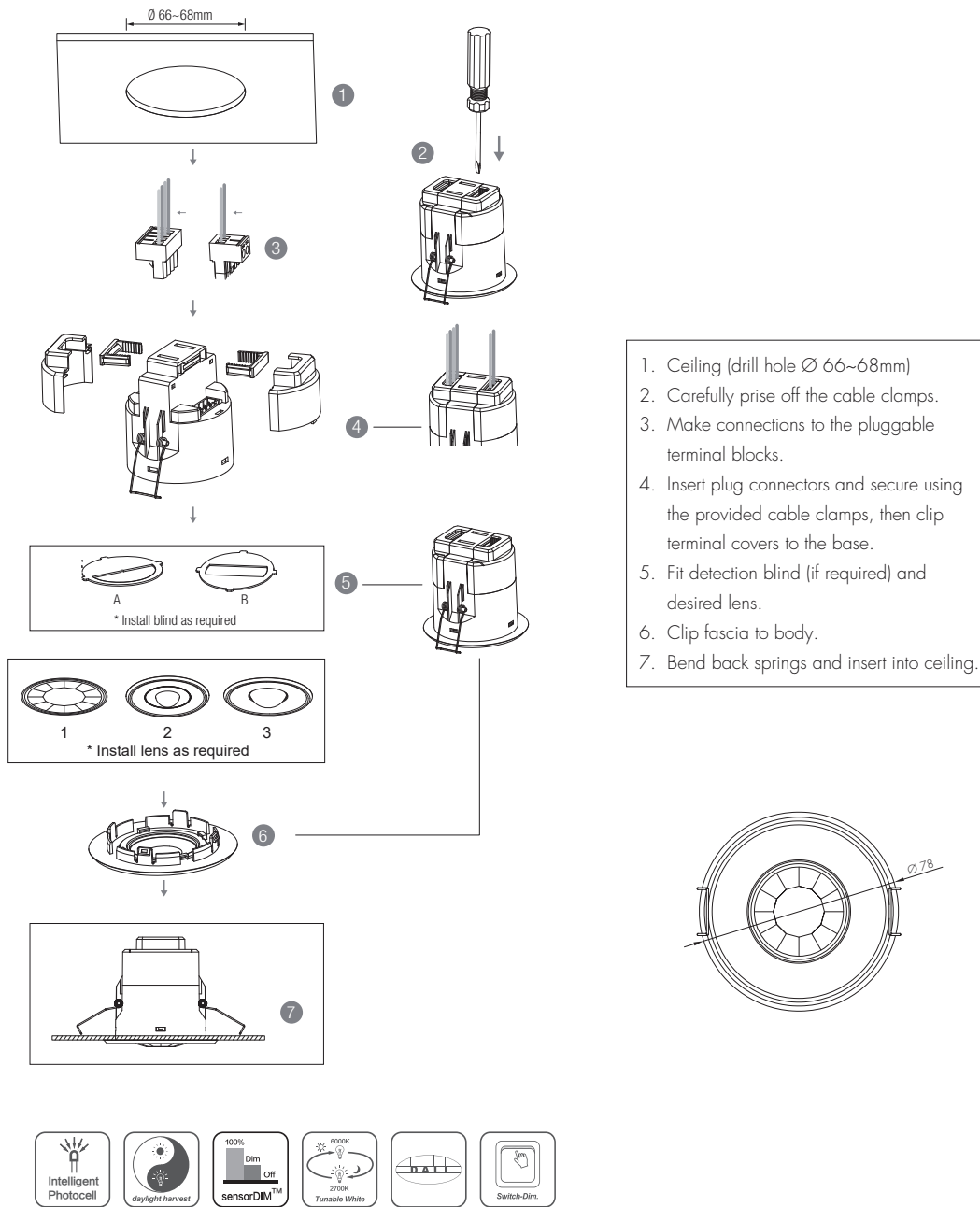

Note: We recommend the mounting distance between sensor to sensor should be more than 2m to prevent sensors from false-triggering.

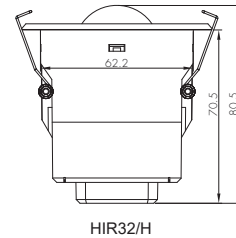
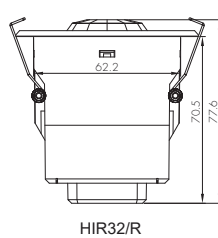
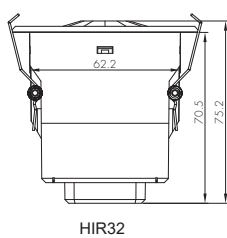

Wiring Diagram

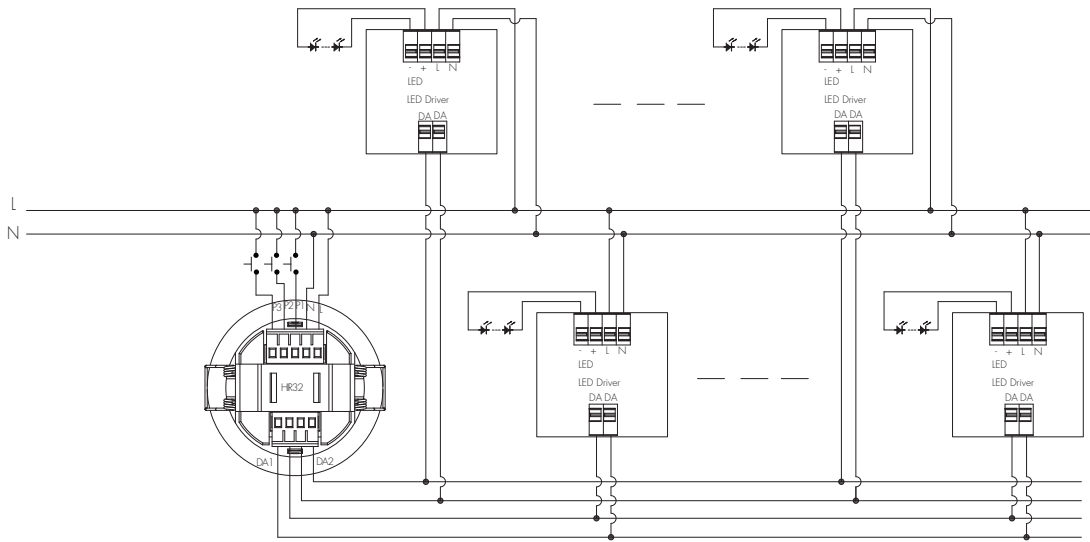

Wire Preparation

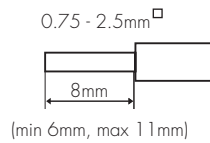

Pluggable screw terminal. It is recommended to make connections to the terminal before fitting to the sensor.

1. 200 metres (total) max. for 1mm² CSA (Ta = 50°C)
2. 300 metres (total) max. for 1.5mm² CSA (Ta = 50°C)

Big and small silicon gasket used to make IP54 degree protection when HIR32 series device mounted into HA09 housing for ceiling mount

Small silicon water-proof gasket dimension(size:mm)

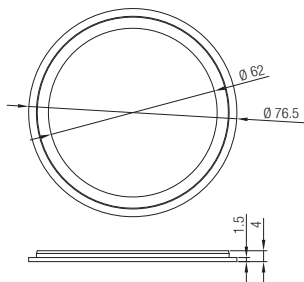

Big silicon water-proof gasket dimension(size:mm)

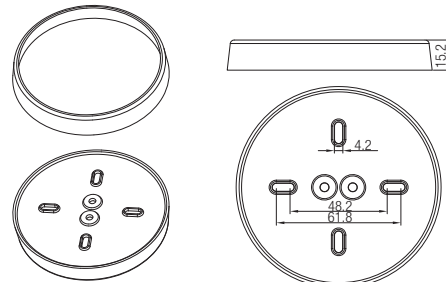

1. HIR32 (Low-bay)



HIR32: Low-bay flat lens detection pattern for **single person** @ $T_a = 20^{\circ}\text{C}$

(Recommended ceiling mount installation height **2.5m-6m**)

A: Tangential movement	B: Radial movement	Mount height	Tangential (A)	Radial (B)
		2.5m	max 50m ² (Ø = 8m)	max 13m ² (Ø = 4m)
		3m	max 64m ² (Ø = 9m)	max 13m ² (Ø = 4m)
		4m	max 38m ² (Ø = 7m)	max 13m ² (Ø = 4m)
		5m	max 38m ² (Ø = 7m)	max 13m ² (Ø = 4m)
		6m	max 38m ² (Ø = 7m)	max 13m ² (Ø = 4m)

Optional Accessory -- Ceiling/Surface Metal Mount Box: HA09/W, HA09/B, HA09/G

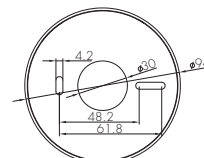
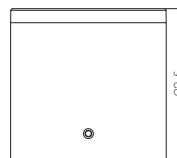

Optional Accessory -- Blind Insert for Blocking Certain Detection Angles

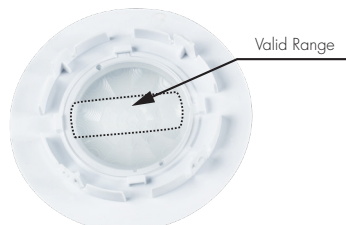

Blind Option 1 --- Aisle Detection



Blind Option 2 --- 180° Detection

2. HIR32/R (Reinforced Low-bay)



HIR32/R: Low-bay convex lens detection pattern for **single person** @ $T_a = 20^\circ\text{C}$
 (Recommended ceiling mount installation height **2.5m-6m**)

A: Tangential movement

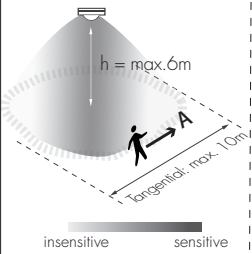

B: Radial movement

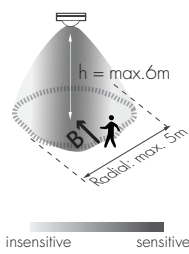

Mount height	Tangential (A)	Radial (B)
2.5m	max 79m ² (∅ = 10m)	max 20m ² (∅ = 5m)
3m	max 79m ² (∅ = 10m)	max 20m ² (∅ = 5m)
4m	max 64m ² (∅ = 9m)	max 20m ² (∅ = 5m)
5m	max 50m ² (∅ = 8m)	max 20m ² (∅ = 5m)
6m	max 50m ² (∅ = 8m)	max 20m ² (∅ = 5m)

Optional Accessory --- Ceiling/Surface Metal Mount Box: HA09/W, HA09/B, HA09/G

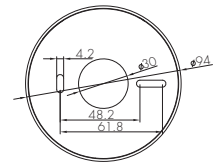
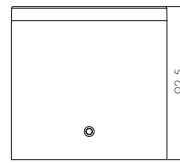
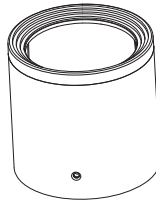

Optional Accessory --- Blind Insert for Blocking Certain Detection Angles

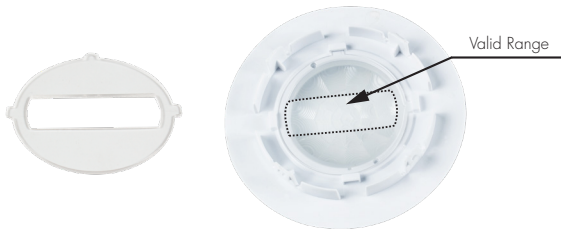

Blind Option 1 --- Aisle Detection



Blind Option 2 --- 180° Detection

3. HIR32/H (High-bay)



HIR32/H: High-bay lens detection pattern for **forklift** @ $T_a = 20^\circ\text{C}$

(Recommended ceiling mount installation height **10m-15m**)

A: Tangential movement

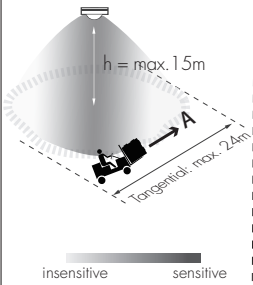

B: Radial movement

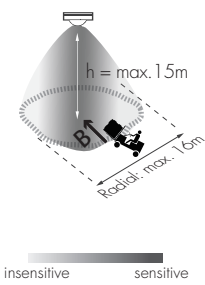

Mount height	Tangential (A)	Radial (B)
10m	max 380m ² (Ø = 22m)	max 201m ² (Ø = 16m)
11m	max 452m ² (Ø = 24m)	max 201m ² (Ø = 16m)
12m	max 452m ² (Ø = 24m)	max 201m ² (Ø = 16m)
13m	max 452m ² (Ø = 24m)	max 177m ² (Ø = 15m)
14m	max 452m ² (Ø = 24m)	max 133m ² (Ø = 13m)
15m	max 452m ² (Ø = 24m)	max 113m ² (Ø = 12m)



HIR32/H: High-bay lens detection pattern for **single person** @ $T_a = 20^\circ\text{C}$

(Recommended ceiling mount installation height **2.5m-12m**)

A: Tangential movement

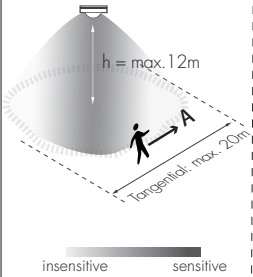

B: Radial movement

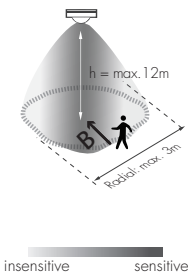

Mount height	Tangential (A)	Radial (B)
2.5m	max 50m ² (Ø = 8m)	max 7m ² (Ø = 3m)
6m	max 104m ² (Ø = 11.5m)	max 7m ² (Ø = 3m)
8m	max 154m ² (Ø = 14m)	max 7m ² (Ø = 3m)
10m	max 227m ² (Ø = 17m)	max 7m ² (Ø = 3m)
11m	max 269m ² (Ø = 18.5m)	max 7m ² (Ø = 3m)
12m	max 314m ² (Ø = 20m)	max 7m ² (Ø = 3m)

Optional Accessory --- Ceiling/Surface Metal Mount Box: HA09/W, HA09/B, HA09/G

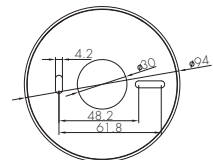
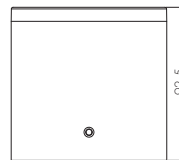

Optional Accessory --- Blind Insert for Blocking Certain Detection Angles

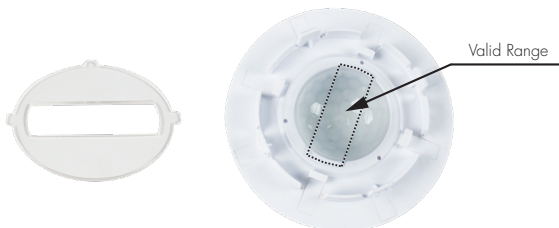

Blind Option 1 --- Aisle Detection

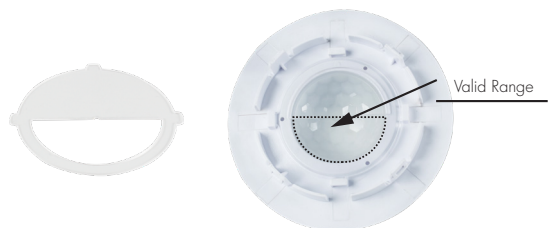

Blind Option 2 --- 180° Detection

1 Daylight Harvest and Lux Off Function

The built-in photocell performs the function of reading the natural daylight, and maintaining the lux level by calculating how much artificial light is needed according to the target lux level required by the profile preset.

Office Application

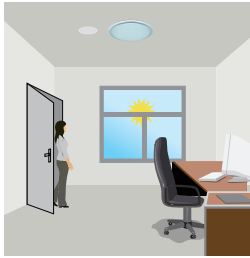

Light will not switch on when natural light is sufficient, even there is motion detected.

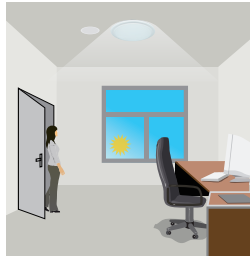

The light switches on automatically with presence when natural light is insufficient.

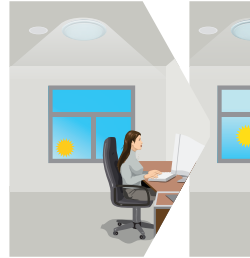

The light turns on at full or dims to maintain the lux level. The light output regulates according to the level of natural light available.

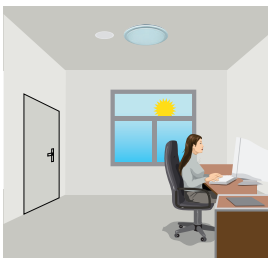
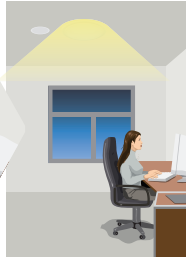

The light dims down and eventually turns off when the ambient natural light is sufficient.

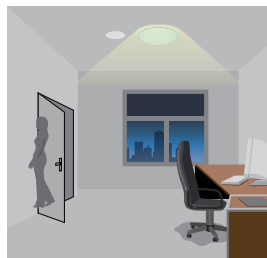

The light goes to stand-by time after hold-time and stays on dimming level.

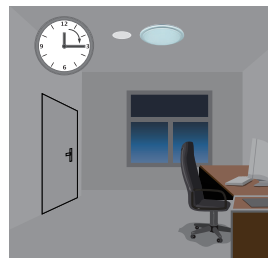

The light switches off completely after hold-time.

2 Dual DALI Output Control

Two channels of self-powered DALI output are available on HIR32 for connection of two groups of LED drivers. Please note that both channels share the same control settings sent from the occupancy sensor and photocell.

System Capacity	DALI channel	DALI Driver < 2mA
HIR32 includes 2 channels total 80mA max. DALI PSU	DALI PSU Channel 1 (max 50mA)	25 pcs
	DALI PSU Channel 2 (max 30mA)	15 pcs

3 Manual Override (Push Function)

Three push terminals (P1, P2, P3) are available on the HIR32 for end-users to switch on/off, change the light brightness, colour temperature of the two DALI channels temporarily. The settings will revert to daylight harvest mode after sensor time-out.

- * Long push on P1: adjust the hold-time light brightness of DALI channel 1 ;
Short push (< 1s) on P1: on/off function
- * Long push on P2: adjust the hold-time light brightness of DALI channel 2 ;
Short push (< 1s) on P2: on/off function
- * Long push on P3: cycles through colour tuning on both channels. (work with DT8 LED driver only)
Short push (< 1s) on P3: resume automatic daylight harvest mode .

Settings (Remote Control HRC-11)



Permanent ON/OFF function

Press button "ON/OFF" to select permanent ON or permanent OFF mode.
* Press button "AUTO", "RESET" to quit this mode.



Reset Settings

Press button "RESET", all settings go back to default:
Hold-time 5min, Daylight sensor 100Lux, Stand-by time: 10min, Stand-by dimming level: 20%



Test Mode

This button is for testing purpose only. The sensor goes to test mode (hold-time is 2s) after commissioning, meanwhile the stand-by period and daylight sensor are disabled.
* This mode can be ended by pressing "reset", or any button of "scene mode" and "hold-time". The sensor settings are changed accordingly.



Shift Button

Press button "Shift", the LED on the top left corner is on to indicate mode selection.
All values / settings in RED are valid for 20 seconds.



AUTO mode

Press button "AUTO" to initiate automatic mode. The sensor starts working and all settings remain as before the light is switched ON/OFF.



SEMI-AUTO mode

1. Press button "Shift", the red LED flashes for indication.
2. Press button "SEMI-AUTO/AUTO" to initiate semi-auto mode. The fixture is manually turned on by pressing the push-switch, and goes off automatically after stand-by time. (Absence detection mode)



Power output

Press the buttons to select light output at 80% (at initial 10,000 hours) or 100%.
Note: "Sensor off" and "Twilight" functions are disabled.



Brightness +/-

1. Press these two buttons to adjust the light output brightness and set a new target lux level. The daylight sensor can measure ambient daylight level and ignore the LED light, so as to calculate how much artificial light is needed to maintain the target lux level.
2. Press "Shift" button first, then press "+/-" button for colour tuning (work with DT8 LED driver only).



Scene program - 1-key commissioning

1. Press button "Start" to program.
2. Select the buttons in "Detection range", "Daylight threshold", "Hold-time", "Stand-by time", "Stand-by dimming level" to set all parameters.
3. Press button "Memory" to save all the settings programmed in the remote control.
4. Press button "Apply" to set the settings to each sensor unit(s).

For example, to set detection range 100%, daylight threshold Disable, hold-time 5min, stand-by time +∞, stand-by dimming level 30%, the steps should be: Press button "Start", button "100%", "Disable", "Shift", "5min", "Shift", "+∞", "30%", "Memory". By pointing to the sensor unit(s) and pressing "Apply", all settings are passed on the sensor(s).

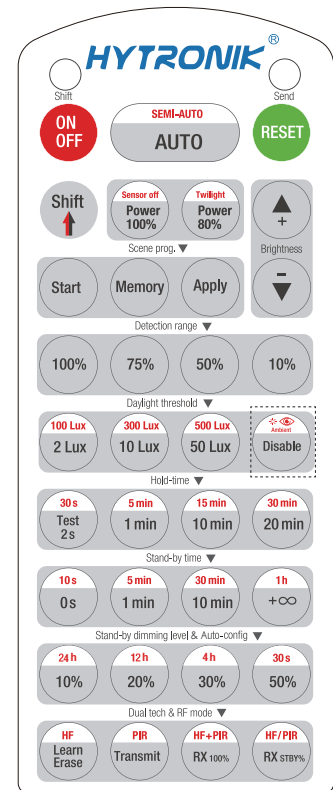

HRC-11

Detection range

All buttons are disabled, the detection range is default to maximum.

Daylight threshold

Press buttons in zone "Daylight threshold" to set daylight sensor at 2Lux / 10Lux / 50Lux / 100Lux / 300Lux / Disable.

Ambient daylight threshold

1. Press button "Shift", the red LED starts to flash.
2. Press button "Ambient", the surrounding lux level is sampled and set as the new daylight threshold.

Hold-time

Press buttons in zone "hold-time" to set the hold-time at 2s / 30s / 1min / 5min / 10min / 15min / 20min / 30min.

Note: 1. To set hold-time at 30s / 5min / 15min / 30min, press "Shift" button first.

2. 2s is for testing purpose only, stand-by period and daylight sensor settings are disabled in this mode.

*To exit from Test mode, press button "RESET" or any button in "Hold-time".

Stand-by time (corridor function)

Press buttons in zone "stand-by time" to set the stand-by period at 0s / 10s / 1min / 5min / 10min / 30min / 1h / +∞.

Note: "0s" means on/off control; "+∞" means bi-level control, the fixture is 100% on when there is motion detected, and remains at the stand-by dimming level when no presence after motion hold-time.

Stand-by dimming level

Press the button in zone "stand-by dimming level" to set the stand-by dimming level at 10% / 20% / 30% / 50%.

Auto-configuration function

All buttons in this zone are disabled.

Dual tech & RF mode

All buttons are disabled.

Note: We recommend customers to calibrate device real-time on yearly-based or half-yearly based by opening the App and connecting to the network, in order to eliminate accumulated time error and make sure all time-related functions to work well.

Additional Information / Documents

1. Regarding precautions for PIR sensor installation and operation, please kindly refer to [www.hytronik.com/download ->knowledge ->PIR Sensors - Precautions for Product Installation and Operation](http://www.hytronik.com/download->knowledge->PIR%20Sensors%20-%20Precautions%20for%20Product%20Installation%20and%20Operation)
2. Regarding Hytronik standard guarantee policy, please refer to [www.hytronik.com/download ->knowledge ->Hytronik Standard Guarantee Policy](http://www.hytronik.com/download->knowledge->Hytronik%20Standard%20Guarantee%20Policy)