

PIR Sensors for Highbay and Lowbay Luminaires

HYTRONIK®

HIR09x, HIR10 PIR Sensor Heads
Built-in Detachable Version



Applications

These PIR sensor heads are specially designed for highbay and lowbay luminaire designs. Offering IP65 / IP64 miniaturised designs, they allow the luminaire designer freedom of placement for high performance lighting controls with aesthetically pleasing results.

They work with HCO38V, HCD038 1-10V or DALI base units for use with your preferred LED driver, or for further space and cost reduction, connect directly with our Hex-drive™ range of LED drivers.

- Car Parks
- High-bay / Low-bay Warehouse
- Cold storage rooms
- Clean rooms

HIR09/S

IP64 surface mounting PIR unit (fascia only) with daylight harvest photocell. Up to 12m mounting height for highbay applications.

HIR09/F

IP64 PIR unit (fascia only) with daylight harvest photocell and flush mount fixing ring. Up to 12m mounting height for highbay applications.

HIR09/C

IP64 PIR unit (fascia only) with daylight harvest photocell. Features moulded threaded bolt for screw fixing to the luminaire. Up to 12m mounting height for highbay applications.

HIR10

IP65 PIR sensor heads with daylight harvest photocell. Flush mount fixing and low profile design. HIR10 designed for up to 12m highbay luminaire designs.



Technical Data For Sensor Heads

PIR Sensor Properties	
Sensor principle	PIR detection
Operation voltage	5VDC
Detection range *	HIR09x (Ø x H) 16m x 12m HIR10 (Ø x H) 18m x 6m x 15m
Detection angle	360°

Environment	
Operation temperature	Ta: -20°C ~ +50°C
Relative Humidity	20% - 90%
IP rating	IP65

* The detection range is heavily influenced by antenna placement (angle of approach) and different walking paces. It may be reduced under certain conditions.

HIRO9x

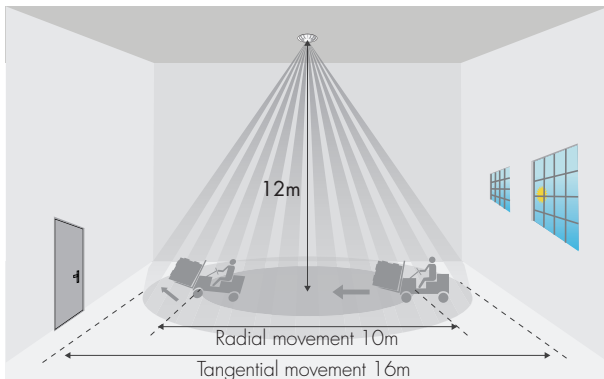

HIR10

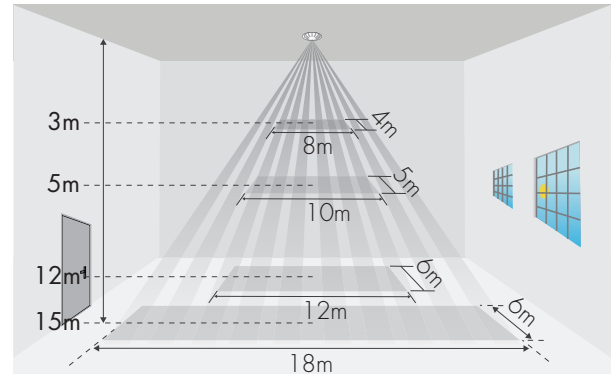

*The detection patterns are based upon 5km/h movement speed.

Dimensions and Terminals

PIR Sensor Head

A. HIRO9/S

Surface mounting
Daylight harvest
For highbay application
IP64
The cable length is around 30cm.

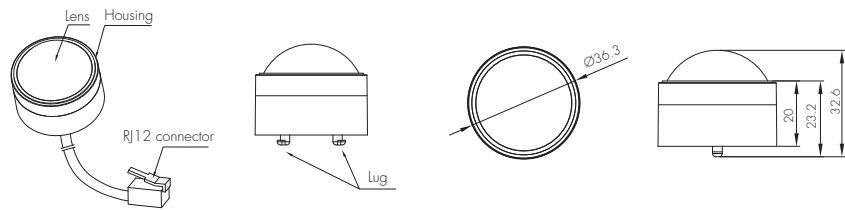

B. HIRO9/F

Flush mounting
Daylight harvest
For highbay application
IP64
The cable length is around 30cm.

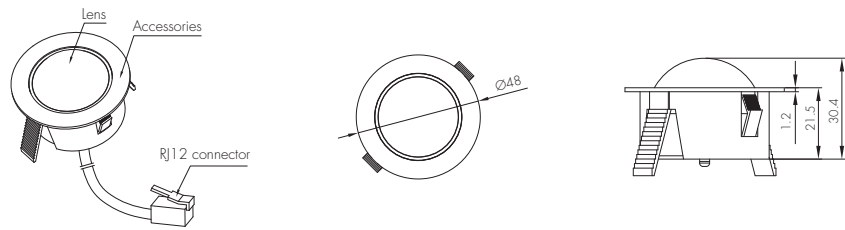

C. HIRO9/C

Screw to the luminaire by conduit
Daylight harvest
For highbay application
IP64
The cable length is around 30cm.

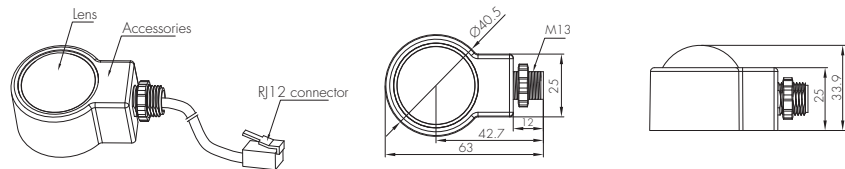

D. HIR10

PIR sensor head
Daylight harvest
For highbay / lowbay application
IP65
The cable length is around 30cm.

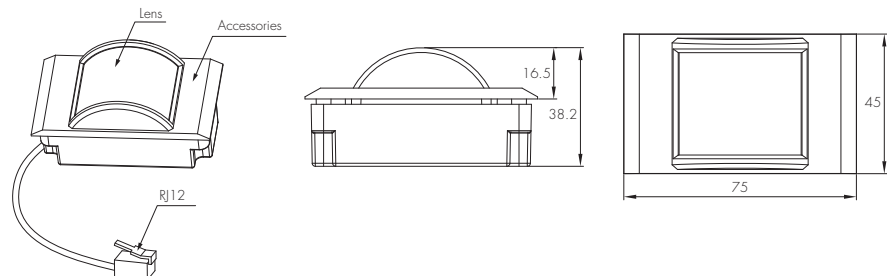

Note: We recommend the mounting distance between sensor to sensor should be more than 2m to prevent sensors from false-triggering.

Using HIR09x, HIR10 with HC038V & HCD038

HC038V 1-10V Control Base

A PIR sensor head with 1-10V dimming output, the linear shape control base HC038V can be built behind the PCB board. It is also perfect for applications where space is restricted for cables and externally mounted lighting controls. Features manual switch input and port for a range of miniature antennas.



1-10V output









HCD038 DALI Control Base

This device contains the same features of the HC038V above. Instead of 1-10V dimming output, the HCD038 features DALI control with a 30mA power supply for up to 15 LED driver connections.



DALI output

Features

-  30mA Broadcast DALI output for up to 15 LED drivers per node
-  1-10V output control option
-  Daylight harvest function to regulate light output for maintaining required lux level
-  Tri-level dimming control based upon occupancy (also known as corridor function)
-   Switch-Dim with synchronization for simple manual override
-  Permanent settings memory, protected against loss of power
-  5-year warranty

Technical Data For Control Base (HC038V / HCD038)

Input Characteristics	
Mains voltage	220~240VAC 50/60Hz
Stand-by power	<0.5W
Load ratings:	
HC038V	400VA (capacitive) 800W (resistive)
HCD038	30mA, 16VDC (max. 15 devices)
Warming-up	20s

Safety and EMC (Common Data)	
EMC standard (EMC)	EN55015, EN61000, EN61547
Safety standard (LVD)	EN60669, AS/NZS60669
Radio Equipment (RED)	EN300440, EN301489 EN62479, EN300328
Certification	Semko, CB, CE, EMC, RED, RCM

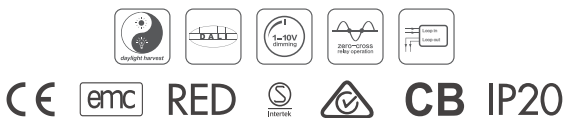

Environment	
Operation temperature	Ta: -20°C ~ +50°C
Case temperature (Max.)	Tc: +80°C
IP rating	IP20

Control Base

A. HC038V (1-10V output)

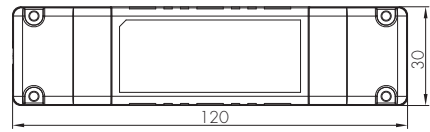
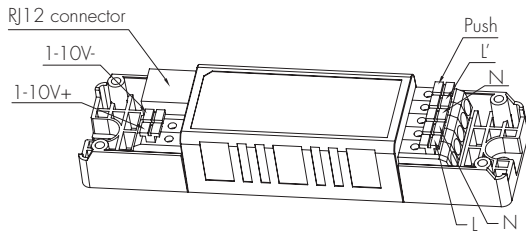

B. HCD038 (DALI output)

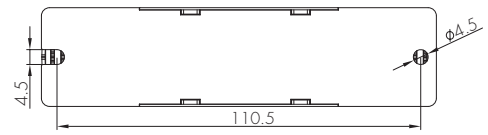
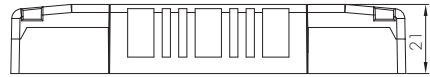
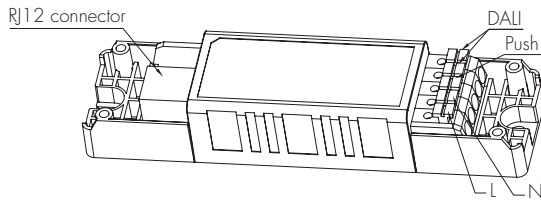

Wire Preparation

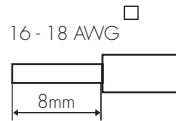
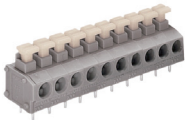

To make or release the wire from the terminal, use a screwdriver to push down the button.

1-10V version

Wiring Diagram

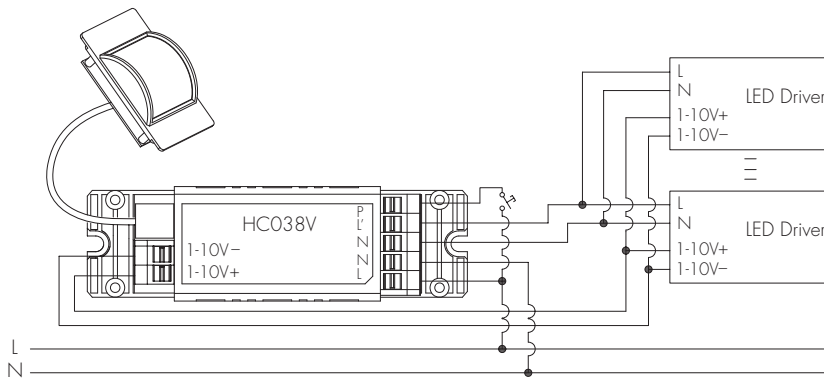

DALI version

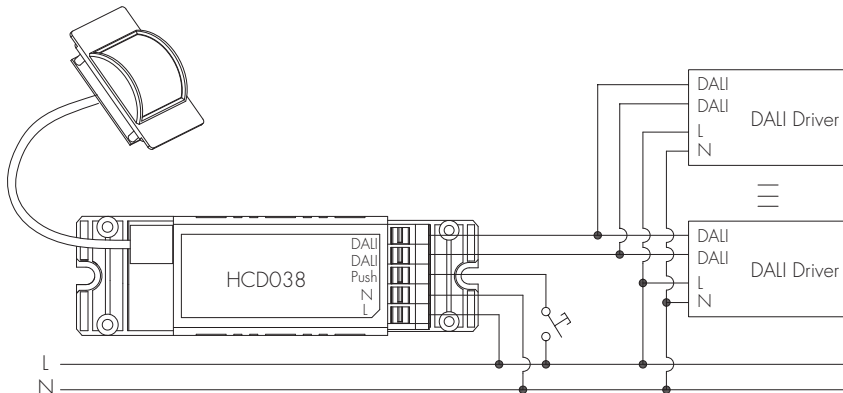

2 Daylight Harvest and Lux Off Function

The built-in photocell performs the function of reading the natural daylight, and maintaining the lux level by calculating how much artificial light is needed according to the target lux level required by the profile preset.

Office Application



Light will not switch on when natural light is sufficient, even there is motion detected.

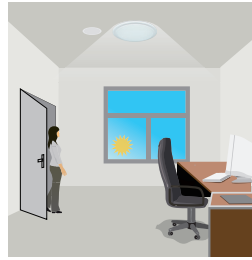

The light switches on automatically with presence when natural light is insufficient.

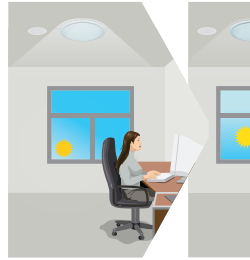

The light turns on at full or dims to maintain the lux level. The light output regulates according to the level of natural light available.

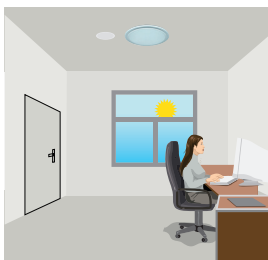
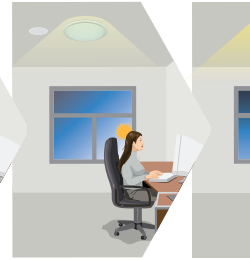

The light dims down and eventually turns off when the ambient natural light is sufficient.

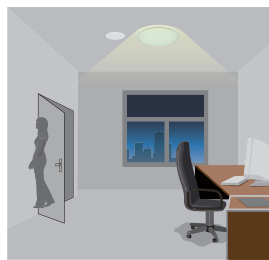

The light goes to stand-by time after hold-time and stays on dimming level.



The light switches off completely after hold-time.

3 Daylight Interactive Mode



Maximum natural light. is measured

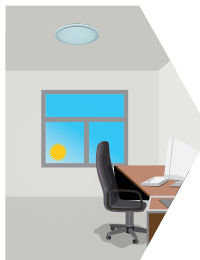

Measurements Continue through auto-configuration period

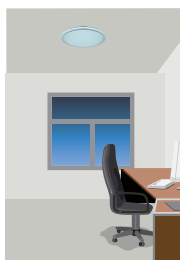

Minimum natural light is measured.

Note: During the auto-configuration period the sensor is inactive and it may appear that the sensor/lights are not working. For this reason it is highly recommended that Auto-configuration is carried out whilst the building is unoccupied

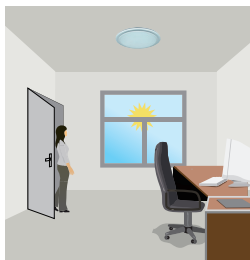

The light turns on at full or dims to maintain the lux level. The light output regulates according to the level of natural light measured during the auto-configuration period. The maximum lux level is determined by the 100% light output level of the luminaire.

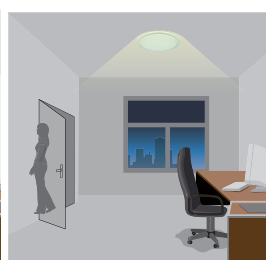
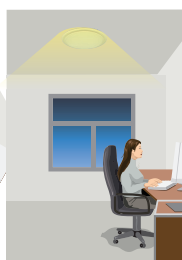
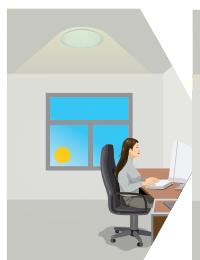

The light goes to stand-by time after hold-time and stays at dimming level.

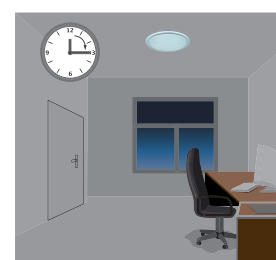

The light switches off completely after hold-time.

Features

1 Manual Override

This sensor reserves the access of manual override function for end-user to switch on/off, or adjust the target lux level by push-switch, which makes the product more user-friendly and offers more options to fit some extra-ordinary demands:

- * Short Push (< 1 s): on/off function;
 - On → Off: the light turns off immediately and cannot be triggered ON by motion until the expiration of pre-set hold-time. After this period, the sensor goes back to normal sensor mode.
 - Off → On: the light turns on and goes to sensor mode, no matter if ambient Lux level exceeds the daylight threshold or not.
- * Long Push (> 1 s): adjust the target lux level by turning the light up or down. Both the adjustment on RC and push switch can overwrite each other, the last adjustment remains in memory.

Note: if end-user do not want this manual override function, just leave the "push" terminal unconnected to any wire.

2 Zero-cross Relay Operation (HC038V)

Designed into the software, the relay switches the load right at the zero-crossing point, to ensure that the in-rush current is minimised thus enabling the maximum lifetime of the relay.

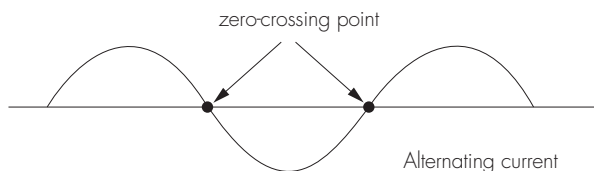











Using HIR09x, HIR10 with Hytronik Hex-Drive™ Constant Current LED Drivers

By simply connecting either HIR10 or HIR10L to the RJ12 connector, the LED driver is automatically enabled for control via the sensor and remote control.

Once the antenna is connected to the Hex-drive™ LED driver, all other control inputs (i.e. DALI & 1-10V) are disabled.

Hytronik Hex-drive™ LED drivers feature a high level of specification which includes:

-  Active PFC Design
-  Configurable Constant Current (CC) Output via Dip-Switch
-  Analogue Flicker-free Dimming
-  Logarithmic Dimming with Multiple Dimming Inputs:
-  Intelligent Thermal Management
-  Thermal Cut-out Protection
-  Short Circuit Protection
-  Over-load Protection
-  Permanent Settings Memory, Protected against Loss of Power
-  5-year warranty, designed for long lifetime up to 50,000 h

} All with Auto-restart



Technical Data

The following data is given as an overview of the Hex-drive™ range for reference in accordance with the HBT01 and HBT02 Bluetooth® wireless technology products. For full data, please refer to our dedicated Hex-drive™ datasheets.

Model No.		HED1025	HED1045	HED1050H	HED1050L	HED1080H	HEC7030/BF
Input	Mains Voltage	220~240VAC 50/60Hz					
	Mains Current	0.15~0.13A	0.22~0.2A	0.3~0.25A	0.3~0.25A	0.45~0.4A	0.17~0.14A
	Power Factor	0.9	0.95	0.95	0.96	0.95	0.9
	Max. Efficiency	88%					
	Dielectric Strength	Input→Output : 3000VAC					
	Leakage Current	< 0.25mA					
Output	Ripple Current	<3%	<3%	<3%	<3%	<3%	<3%
	Uout Max.	90V	75V	110V	200V	120V	70V
	Turn-on Time	< 0.5s	< 0.5s	< 0.5s	< 0.5s	< 0.5s	< 0.5s
	Dimming Interface	DALI, Switch-Dim	DALI, 1-10V, Switch-Dim				DALI, Switch-Dim
Environment	Operation Temp.	Ta: -20~+50°C	Ta: -20~+45°C	Ta: -20~+50°C	Ta: -20~+50°C	Ta: -20~+50°C	Ta: -20~+50°C
	Case Temp. (Max.)	80°C	85°C	80°C	80°C	80°C	85°C
	IP Rating	IP20					
Safety and EMC	EMC Standard	EN55015, EN61547, EN61000-3-2, EN61000-3-3					
	Safety Standard	EN61347-1, EN62493, EN61347-2-13					
	DALI Standard	IEC62386-101 ; IEC62386-102 ; IEC62386-207					
	Certifications	Semko, CB, RCM, CE, EMC					

Model No.	Max. output power/current/voltage range			
HED1025	19.5W/ 325mA /12~60V	21W/ 350mA /12~60V	22.5W/ 375mA /12~60V	24W/ 400mA /12~60V
	25.5W/ 425mA /12~60V	27W/ 450mA /12~60V	26W/ 475mA /12~55V	27.5W/ 500mA /12~55V
	26W/ 525mA /12~50V	27.5W/ 550mA /12~50V	26W/ 575mA /12~45V	27W/ 600mA /12~45V
	28W/ 625mA /12~45V	28W/ 650mA /12~43V	27W/ 675mA /12~40V	28W/ 700mA /12~40V
HED1045	28W/ 500mA /12~56V	40W/ 700mA /12~56V	45W/ 900mA /12~50V	45W/ 1050mA /12~42V
	40W/ 1200mA /12~34V	40W/ 1400mA /12~28V		
HED1050H	40W/ 500mA /12~80V	44W/ 550mA /12~80V	49W/ 600mA /12~80V	49W/ 650mA /12~75V
	49W/700mA /12~70V	50W/ 750mA /12~66V	50W/ 800mA /12~62V	50W/ 850mA /12~59V
	49W/ 900mA /12~55V	49W/ 950mA /12~53V	50W/ 1000mA /12~50V	50W/ 1050mA /12~47V
	50W/ 1100mA /12~45V	50W/ 1150mA /12~43V	50W/ 1200mA /12~42V	
HED1050L	34W/225mA /36~150V	38W/ 250mA /36~150V	41W/ 275mA /36~150V	45W/ 300mA /36~150V
	49W/325mA /36~150V	50W/ 350mA /36~140V	50W/ 375mA /36~130V	50W/ 400mA /36~125V
	50W/ 425mA /36~115V	50W/ 450mA /36~110V	50W/ 475mA /36~105V	50W/ 500mA /36~100V
	50W/ 525mA /36~95V	50W/ 550mA /36~90V	50W/ 575mA /36~86V	50W/ 600mA /36~83V
HED1080H	67W/900mA /16~75V	71W/ 950mA /16~75V	75W/ 1000mA /16~75V	78W/ 1050mA /16~74V
	79W/ 1100mA /16~72V	80W/ 1150mA /16~70V	80W/ 1200mA /16~66V	80W/ 1250mA /16~64V
	80W/ 1300mA /16~61V	80W/ 1350mA /16~59V	80W/ 1400mA /16~57V	80W/ 1450mA /16~55V
	80W/1500mA /16~53V	80W/ 1550mA /16~51V	80W/ 1600mA /16~50V	80W/ 1650mA /16~48V
HEC7030/BF	21W/350mA /10~60V	30W/ 500mA /10~60V	30W/ 550mA /10~55V	30W/ 700mA /10~43V
	30W/750mA /10~40V	23W/ 900mA /10~25V		

Dimensions and Terminals

Model: HED1025 1x25W

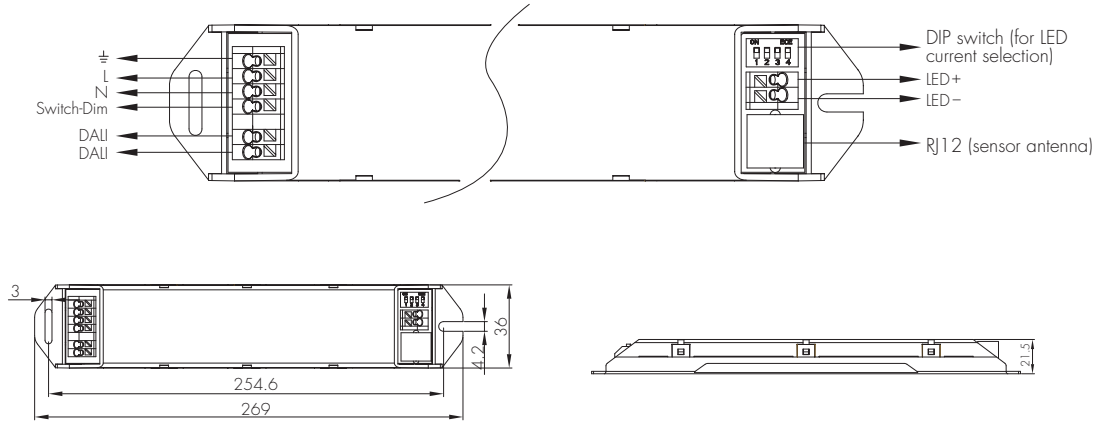

Model: HED1050H 1x50W high current
 HED1050L 1x50W low current
 HED1080H 1x80W high current

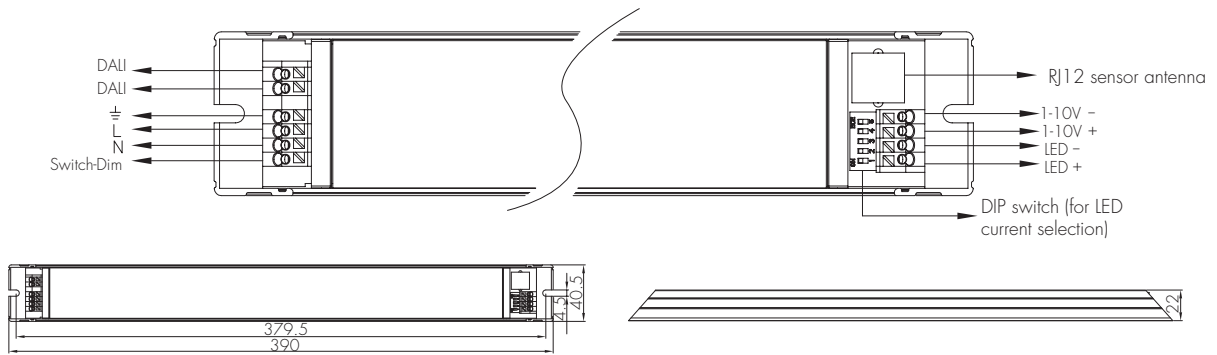

Model: HED1045 1x45W

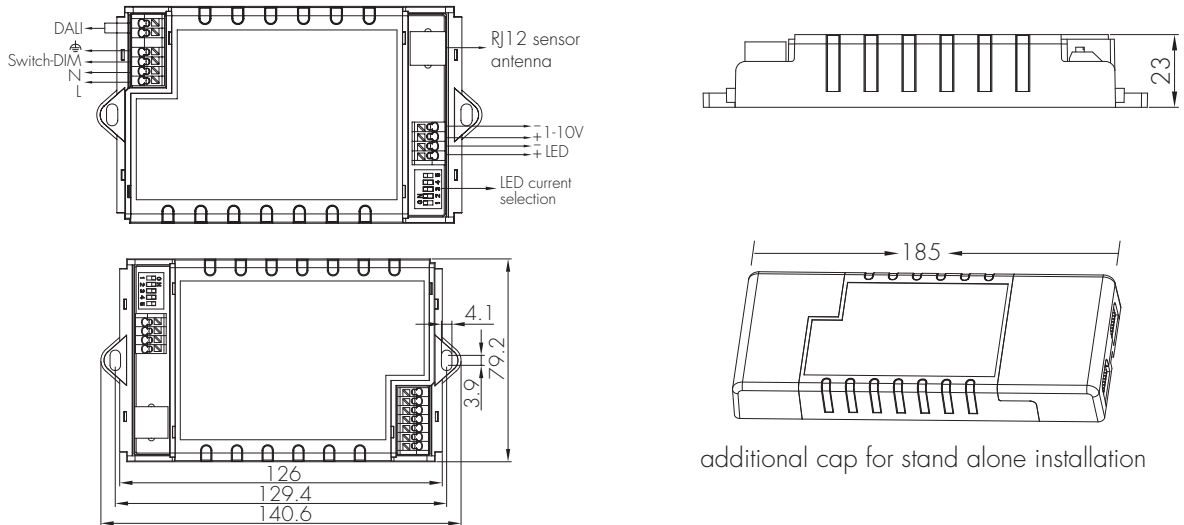

Model: HEC7030/BF 1x30W

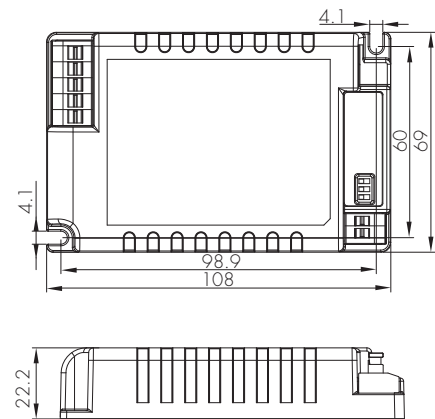
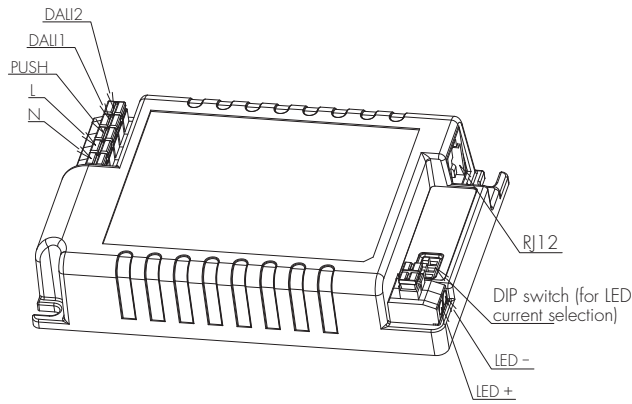

Wire Preparation

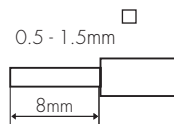

To make or release the wire from the terminal, use a screwdriver to push down the button.

Transceiver Node Connections (with optional Switch-Dim)

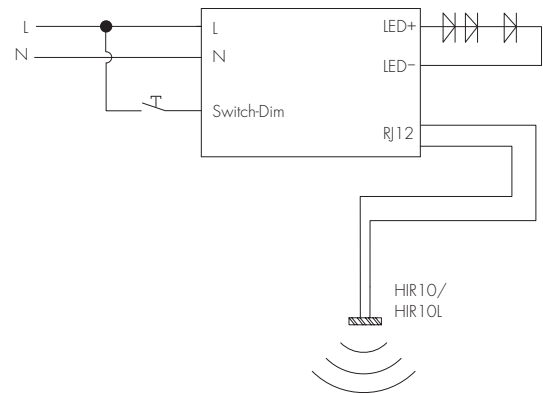

Hardware Features

1 Manual Override (Hex-Drive™ 'Switch-Dim' terminal)

This sensor reserves the access of manual override function for end-user to switch on/off, or adjust the target lux level by push-switch, which makes the product more user-friendly and offers more options to fit some extra-ordinary demands:

* Short Push (< 1 s): on/off function;

On → Off: the light turns off immediately and cannot be triggered ON by motion until the expiration of pre-set hold-time. After this period, the sensor goes back to normal sensor mode.

Off → On: the light turns on and goes to sensor mode, no matter if ambient Lux level exceeds the daylight threshold or not.

* Long Push (> 1 s): adjust the target lux level by turning the light up or down. Both the adjustment on RC and push switch can overwrite each other, the last adjustment remains in memory.

Note: if end-user do not want this manual override function, just leave the "push" terminal unconnected to any wire.

Settings (Remote Control HRC-11)



Permanent ON/OFF function

Press button "ON/OFF" to select permanent ON or permanent OFF mode.

* Press button "AUTO", "RESET" or "Ambient" to quit this mode.



Reset Settings

Press button "RESET", all settings go back to default values as below:

Detection Range 100%, Hold-time 5S, Stand-by Period 10S, Stand-by dimming level 10%, daylight threshold Disabled



Shift Button

Press button "Shift", the LED on the top left corner is on to indicate mode selection.

All values / settings in RED are valid for 20 seconds.



AUTO mode

Press button "AUTO" to initiate automatic mode. The sensor starts working and all settings remain as before the light is switched ON/OFF.



SEMI-AUTO mode

1. Press button "Shift", the red LED flashes for indication.
2. Press button "SEMI-AUTO/AUTO" to initiate semi-auto mode. The fixture is manually turned on by pressing the push-switch, and goes off automatically after stand-by time. (Absence detection mode)



Power output

Press the buttons to select light output at 80% (at initial 10,000 hours) or 100%.

Note: "Sensor off" and "Twilight" functions are disabled.



Brightness +/-

Press these two buttons to adjust the light output brightness and set a new target lux level. The daylight sensor can measure ambient daylight level and ignore the LED light, so as to calculate how much artificial light is needed to maintain the target lux level.



Scene program - 1-key commissioning

1. Press button "Start" to program.
2. Select the buttons in "Detection range", "Daylight threshold", "Hold-time", "Stand-by time", "Stand-by dimming level" to set all parameters.
3. Press button "Memory" to save all the settings programmed in the remote control.
4. Press button "Apply" to set the settings to each sensor unit(s).

For example, to set detection range 100%, daylight threshold Disable, hold-time 5min, stand-by time +∞, stand-by dimming level 30%, the steps should be: Press button "Start", button "100%", "Disable", "Shift", "5min", "Shift", "+∞", "30%", "Memory". By pointing to the sensor unit(s) and pressing "Apply", all settings are passed on the sensor(s).

Detection range

Buttons in zone "Detection range" are disabled.

Daylight threshold

Press buttons in zone "Daylight threshold" to set daylight sensor at 2Lux/ 10Lux / 50Lux / 100Lux / 300Lux / 500Lux / Disable.

Note: To set daylight sensor at 100Lux / 300Lux / 500Lux, press "Shift" button first.

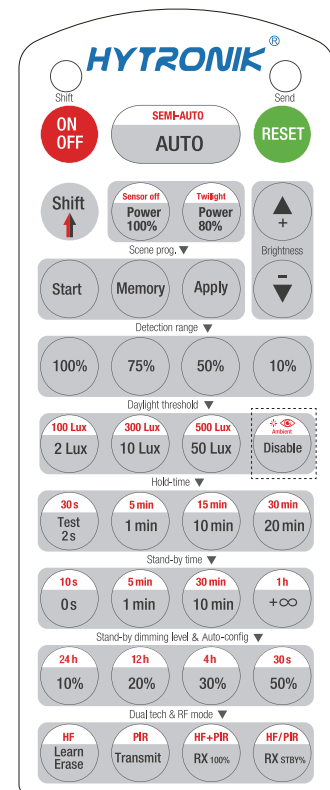

HRC-11

Ambient daylight threshold

1. Press button "Shift", the red LED starts to flash.
2. Press button "Ambient", the surrounding lux level is sampled and set as the new daylight threshold.

Hold-time

Press buttons in zone "hold-time" to set the hold-time at 2s / 30s / 1min / 5min / 10min / 15min / 20min / 30min.

Note: 1. To set hold-time at 30s / 5min / 15min / 30min, press "Shift" button first.

2. 2s is for testing purpose only, stand-by period and daylight sensor settings are disabled in this mode.

*To exit from Test mode, press button "RESET" or any button in "Hold-time".

Stand-by time (corridor function)

Press buttons in zone "stand-by time" to set the stand-by period at 0s / 10s / 1min / 5min / 10min / 30min / 1h / +∞.

Note: "0s" means on/off control; "+∞" means the stand-by time is infinite and the fixture never switches off.

Stand-by dimming level

Press the button in zone "stand-by dimming level" to set the stand-by dimming level at 10% / 20% / 30% / 50%.

Auto-configuration function (daylight interactive mode)

This feature can provide automatic response to natural daylight. During the auto-configuration period the motion sensor is disabled and the lamps will remain off.

1. Press button "Shift", the red LED starts to flash.
2. Press one of the buttons "24h - 30s" to define the configuration measurement period, the longer it can operate, the more accurate the system can make calculations. It is recommended that this procedure is carried when the building is unoccupied as it may appear that the sensor/lights are not working

Dual tech & RF mode

All buttons in this zone are disabled.