

## Tri-level Control & Daylight Harvest Sensor

HC038V HCD038 HCD038/P  
Detached Linear Version with Remote Control

# HYTRONIK®



### Applications

Occupancy detector with tri-level dimming control suitable for indoor use:

- Office / Commercial Lighting
- Classroom
- Meeting Room

Use for new luminaire designs and installations

### Features

- DALI-2 and D4i supported (HCD038/P)
- Daylight harvest function to regulate light output for maintaining required lux level
- Active Lux Switching, daylight threshold prior to motion detection
- Tri-level dimming control based upon occupancy (also known as corridor function)
- Optional 1-10V or DALI dimming control method
- One-touch daylight learning via remote control
- Zero crossing detection circuit reduces in-rush current and prolongs relay life (HC038V)
- Loop-in and loop-out terminal for efficient installation (HC038V)
- 5-year warranty



HC038V

HCD038

HCD038/P

### Technical Data

Input & Output Characteristics	
Operating voltage	220~240VAC 50/60Hz
Stand-by power	<0.5W
Load ratings:	
HC038V	400VA (capacitive) 800W (resistive)
HCD038	max. 30mA
HCD038/P	DALI bus power supply: I max:80mA U rated:15VDC I guranteed:64mA
Warming-up	20s

Environment	
Operation temperature	Ta: -20°C ~ +55°C
Case temperature (Max.)	Tc: +75°C
IP rating	IP20

DALI-2 Standards	
HCD038/P+HIR17	IEC62386 101 IEC62386 103 IEC62386 303 IEC62386 304

Safety & EMC	
EMC standard (EMC)	EN55015, EN61000, EN61547
Safety standard (LVD)	EN60669-1/-2-1, AS/NZS60669-1/-2-1, IEC62386
Radio Equipment (RED)	EN300440, EN301489-1/-3/-17 EN62479, EN300328
Certification	Semko, CB, CE, EMC, RED, RCM, UKCA

PIR Sensor Propertie (HIR17 & HIR17/R)	
Sensor principle	PIR detection
Operation voltage	5VDC
Detection range *	HIR17 Max installation height: 3m (single person) Max detection range (Ø): 12m  HIR17/R Max installation height: 8m (single person) Max installation height: 12m (forklift) Max detection range (Ø): 14m
Detection angle	360°

# Mechanical Structure & Dimensions

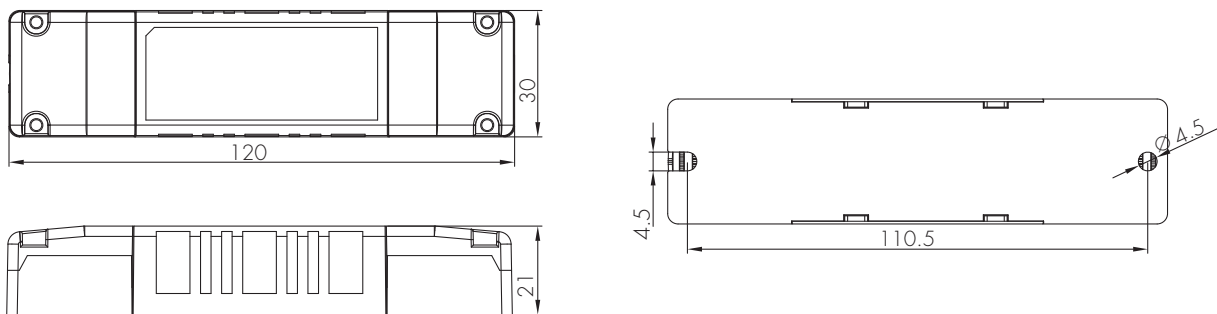

HC038V (1-10V output with 1 push)

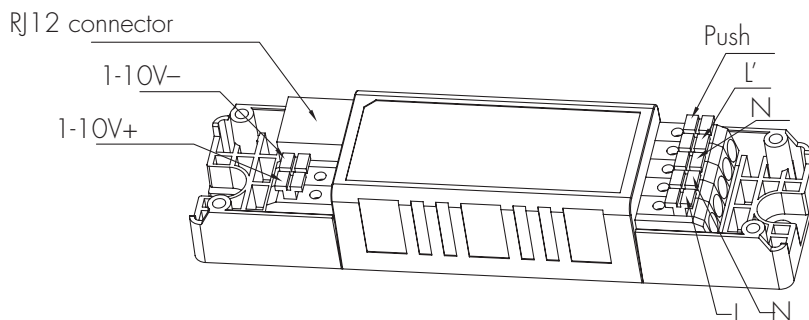

HCD038 (DALI output with 1 push)

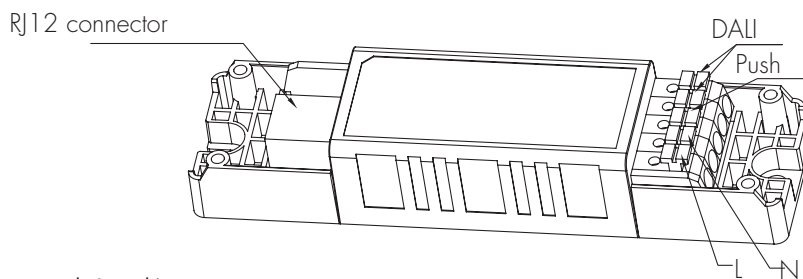

HCD038/P (DALI output with 2 push)

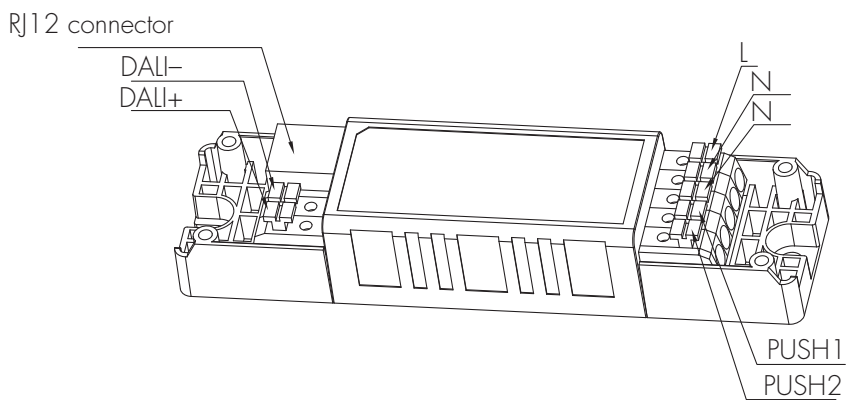

## PIR Sensor Head

### A. HIR17

PIR sensor head  
The cable length is around 30cm.

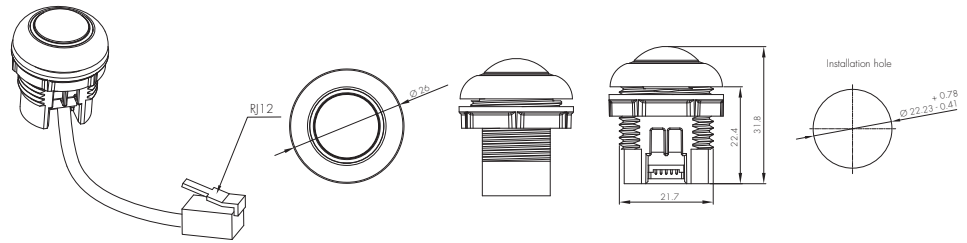

### B. HIR17 with HA04

PIR sensor head  
Optional accessory  
The cable length is around 30cm.

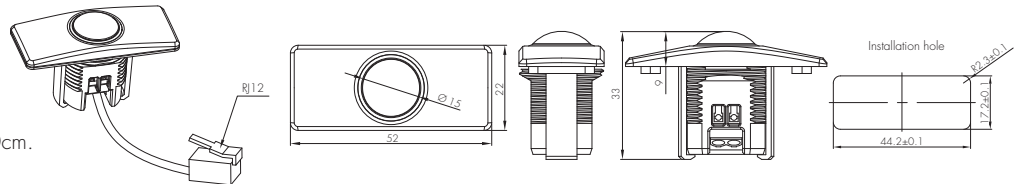

### C. HIR17 with HA05

PIR sensor head  
Optional accessory  
The cable length is around 30cm.

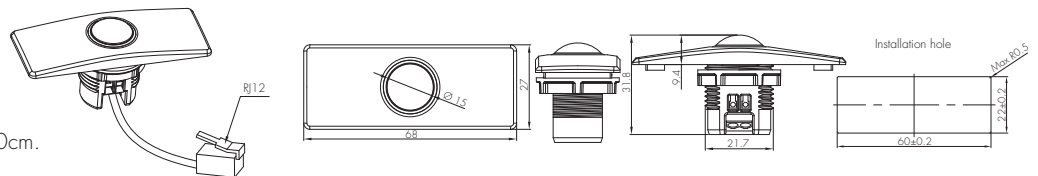

### D. HIR17 with HA10

PIR sensor head  
Optional accessory for recessed ceiling surface  
The cable length is around 30cm.

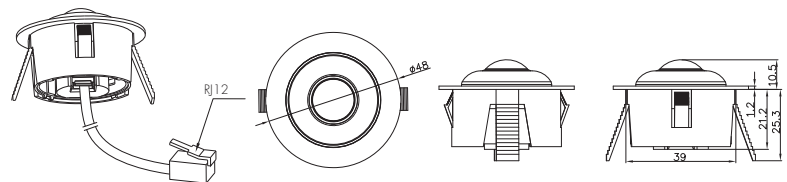

### E. HIR17/R

PIR sensor head  
IP65 (facia / lens part)  
The cable length is around 30cm.

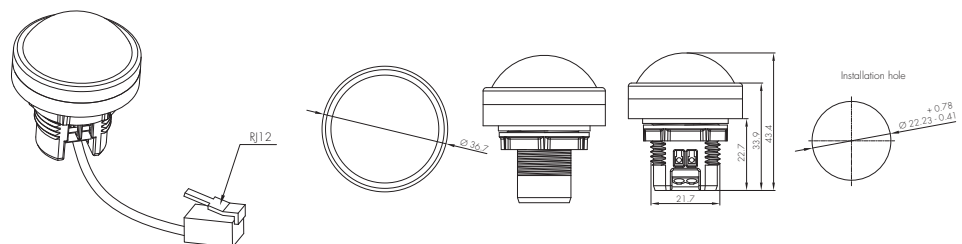

Note: 1. When HIR17 or HIR17/R plug with HCD038/P, only one push terminal can be activated for configuration.  
2. Only when both HCD038/P and HIR17 or HIR17/R are used together, then the combination is DALI-2 enabled as a whole.  
HIR17 can freely switch between tri-level control and daylight harvest through remote controller HRC-11 setting.



Note: We recommend the mounting distance between sensor to sensor should be more than 2m to prevent sensors from false-triggering.

## 1 Tri-level Control (Corridor Function)

Hytronik builds this function inside the motion sensor to achieve tri-level control, for some areas which require a light change notice before switch-off. The sensor offers 3 levels of light: 100%-->dimmed light (natural light is insufficient) -->off; and 2 periods of selectable waiting time: motion hold-time and stand-by period; Selectable daylight threshold and freedom of detection area.



With sufficient natural light, the light does not switch on when presence is detected.



With insufficient natural light, the sensor switches on the light automatically when presence is detected.

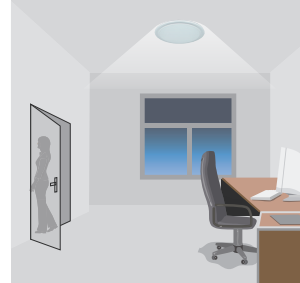

After hold-time, the light dims to stand-by level if the surrounding natural light is below the daylight threshold.



Light switches off automatically after the stand-by period elapses.

## 2 Daylight Harvest



Light will not switch on when natural light is sufficient, even there is motion detected.

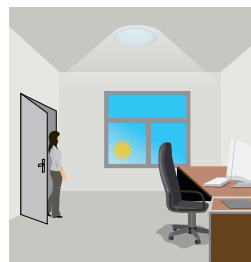

The light switches on automatically with presence when natural light is insufficient.

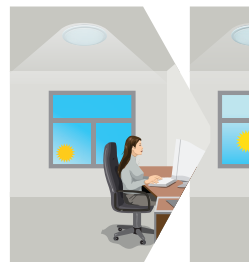

The light turns on at full or dims to maintain the lux level. The light output regulates according to the level of natural light available.

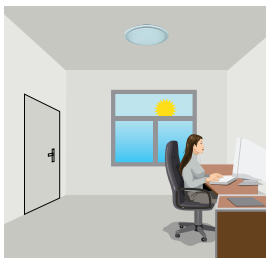
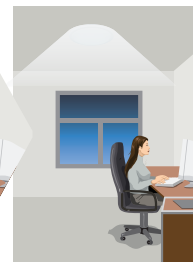
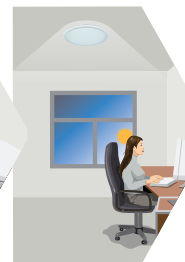
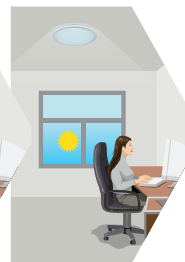

The light switches off when the ambient natural light is sufficient.

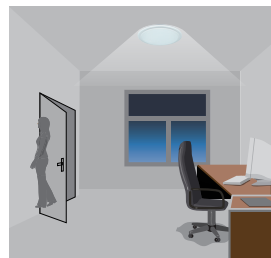

The light dims to stand-by period after hold-time and stays on selected minimum dimming level.



The light switches off completely after the stand-by period.

### Note:

The light automatically dims down and eventually turns off if the natural light lux level exceeds the daylight threshold. However, if the stand-by period is preset at "+∞", the fixture never switches off but dim to minimum level, even the natural light is sufficient.

## 3 Master (HCD038/P)

HIR 17 supports multiple sensors to access DALI network at the same time. In order to prevent conflict during daylight harvest control, you need to manually select one HIR 17 as the master when configuring the network. The master has the control authority of this DALI network. Other HIR 17 will only report sensing events.

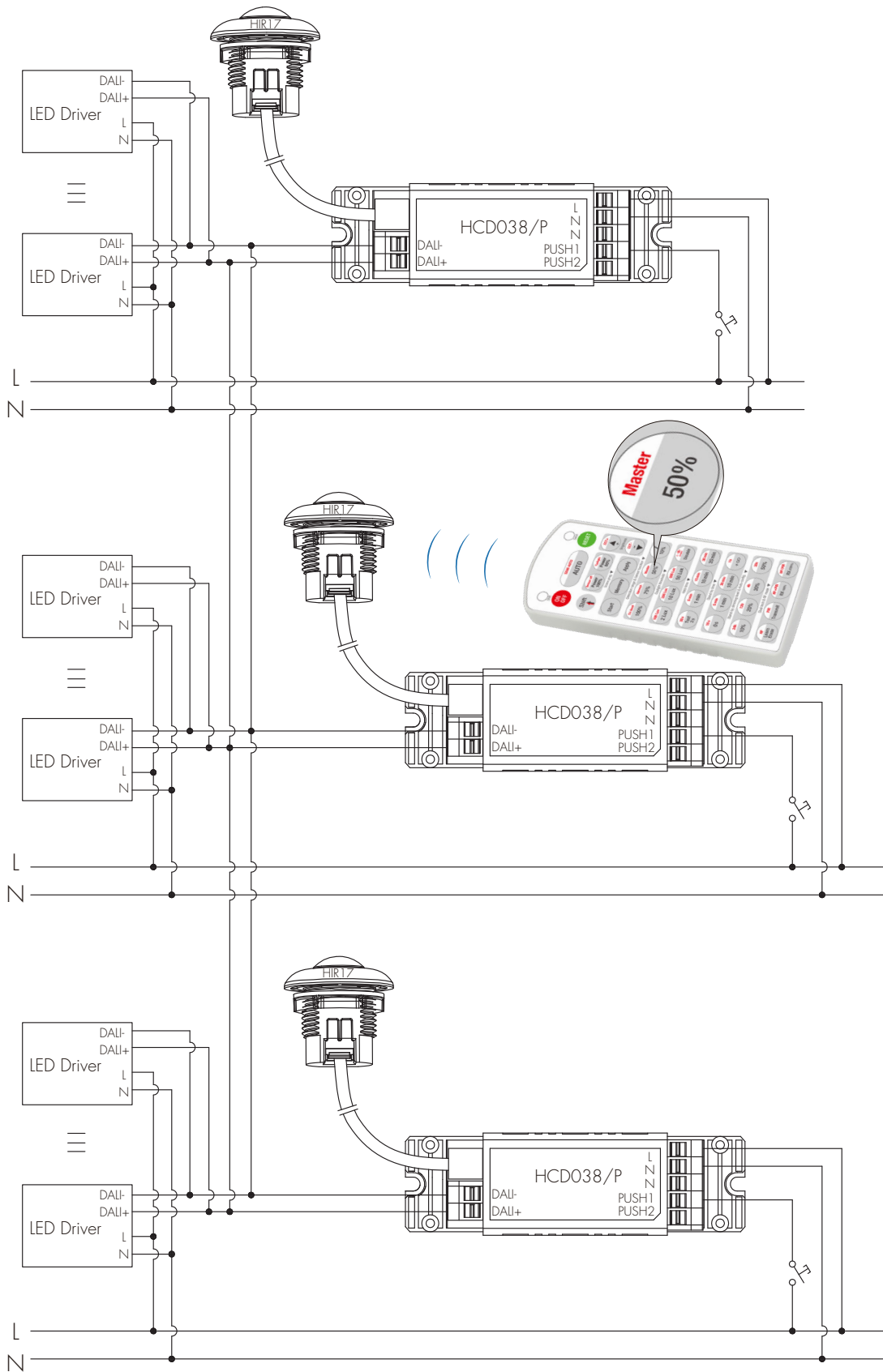

#### 4 Active Lux Switching (Daylight Detection Prior to Motion Detection)

The built-in photocell will also automatically turn off the light when the ambient light exceeds the programmed lux level for more than 5min, regardless of whether motion is detected or not.

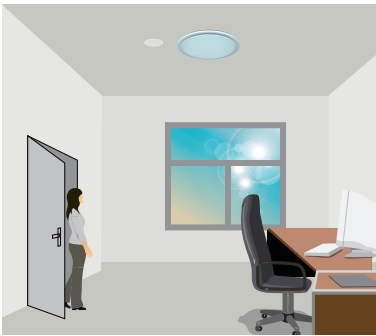

With sufficient ambient light, the light does not switch on when presence is detected.

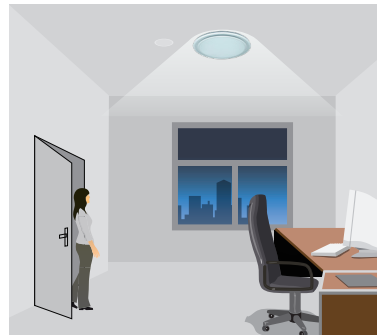

With insufficient ambient light, the sensor switches on the light automatically when presence is detected.

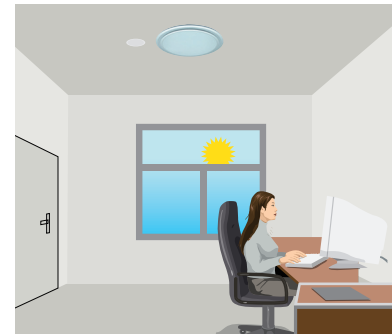

The sensor switches off the light when ambient light is sufficient, even with presence.

#### 5 Manual Override

This sensor reserves the access of manual override function for end-user to switch on/off, or adjust the brightness by push-switch, which makes the product more user-friendly and offers more options to fit some extra-ordinary demands:

\* Short Push (<1s): on/off function;

On → Off: the light turns off immediately and cannot be triggered ON by motion until the expiration of pre-set hold-time. After this period, the sensor goes back to normal sensor mode.

Off → On: the light turns on and goes to sensor mode, no matter if ambient Lux level exceeds the daylight threshold or not.

\* Long Push (>1s): adjust the hold-time brightness level between 10% and 100%.

*Note: if end-user do not want this manual override function, just leave the "push" terminal unconnected to any wire.*

#### 6 Semi-auto Mode (Absence Detection)

It is easy to forget to switch off the light, in office, corridor, even at home. And in many other cases, people do not want to have a sensor to switch on the light automatically, for example, when people just quickly pass-by, there is no need to have the light on. The solution is to apply this "absence detector": motion sensor is employed, but only activated on the manual press of the push switch, the light keeps being ON in the presence, and dims down in the absence, and eventually switches off in the long absence.

This is a good combination of sensor automation and manual override control, to have the maximum energy saving, and at the same time, to keep efficient and comfortable lighting.

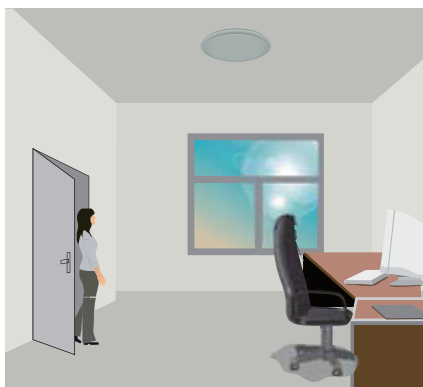

The light does not switch on when there is presence being detected.



Short push to activate the sensor and switch on the light

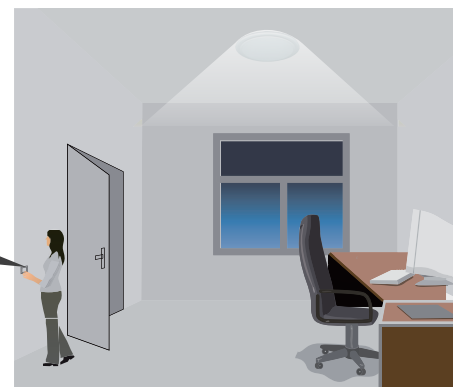

The light turns on full, and the sensor stays in sensor mode.



The light keeps being ON during the presence.

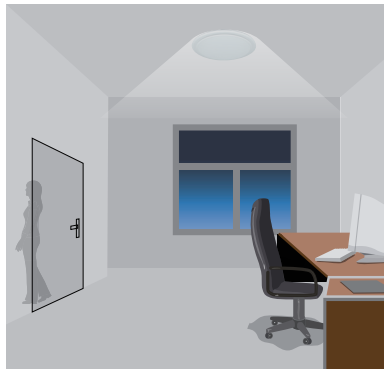

People left, the light dims to stand-by level after the hold-time.



The light switches off automatically after the stand-by period elapses.

Note: end-user can choose either function 5 or function 6 for application. Default function is manual override.

### 7 Zero-cross Relay Operation (HC038V)

Designed in the software, sensor switches on/off the load right at the zero-cross point, to ensure that the in-rush current is minimised, enabling the maximum lifetime of the relay.

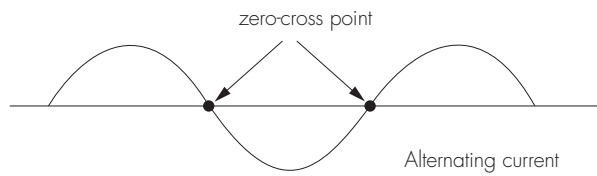

### 8 Loop-in and Loop-out Terminal (HC038V)

Double L N terminal makes it easy for wire loop-in and loop-out, and saves the cost of terminal block and assembly time.

## Wiring Diagram

HC038V

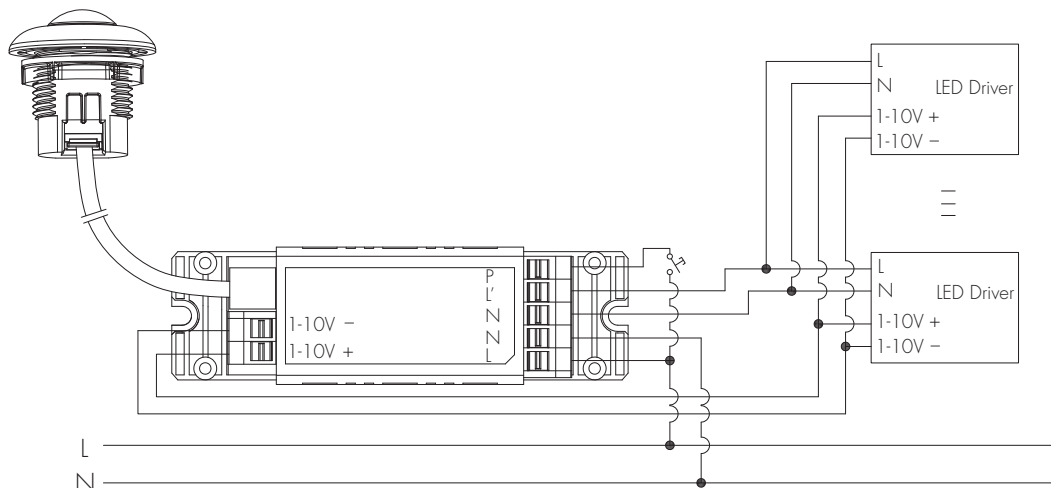

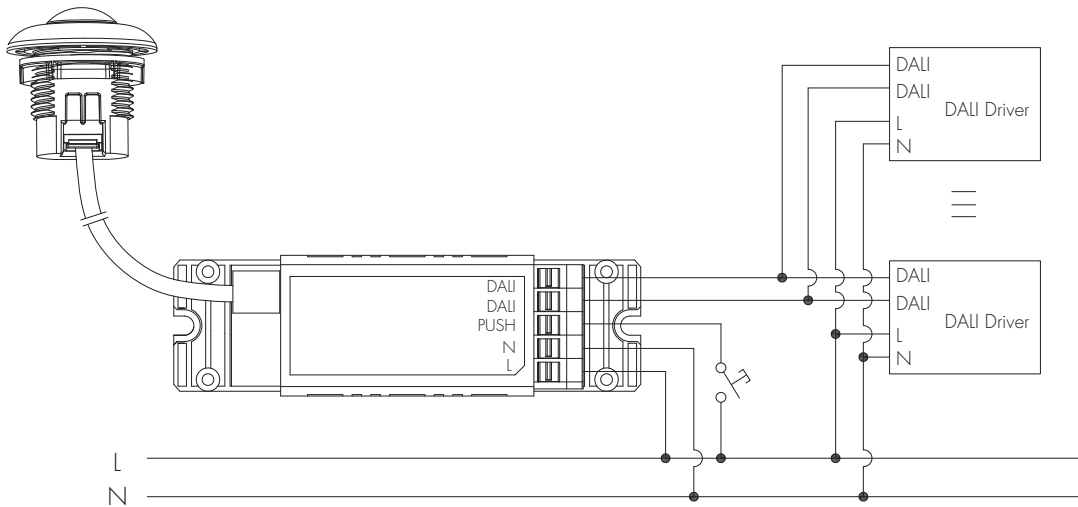

HCD038/P

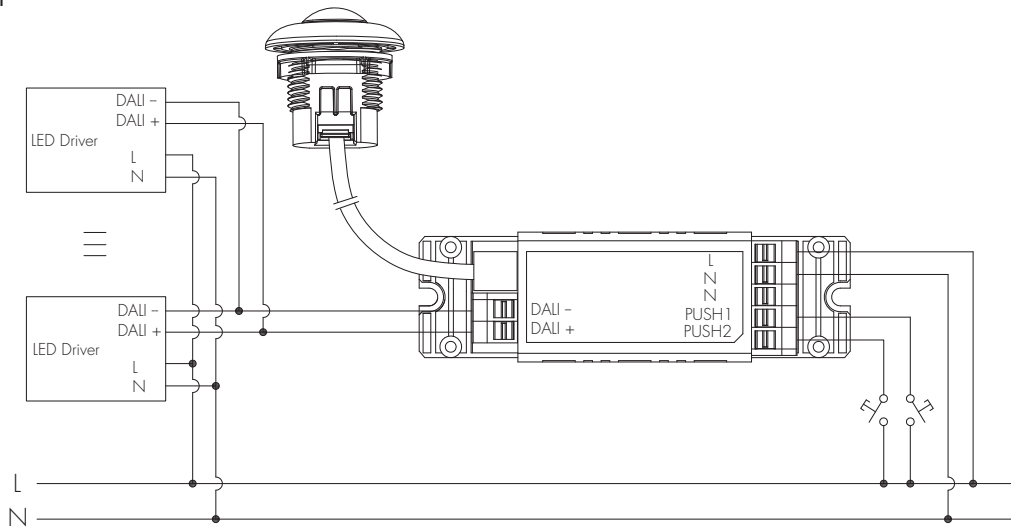

1. 200 metres (total) max. for 1mm<sup>2</sup> CSA (Ta = 50°C)
2. 300 metres (total) max. for 1.5mm<sup>2</sup> CSA (Ta = 50°C)

Detection Pattern

HIR17

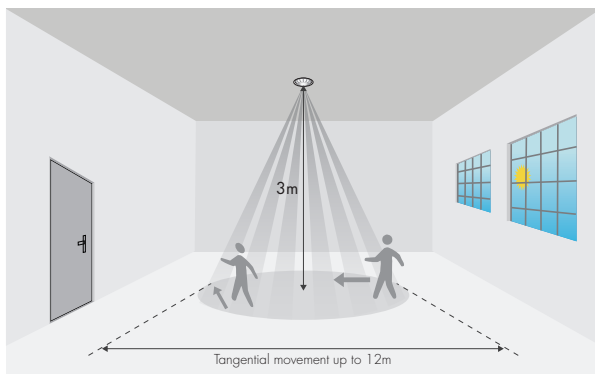

HIR17/R

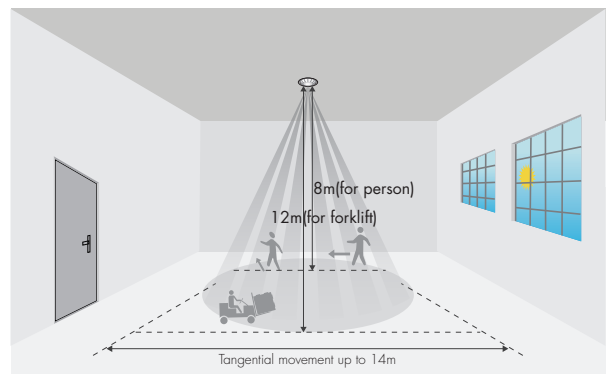

\*The detection patterns are based upon 5km/h movement speed.



## Settings (Remote Control HRC-11, for HIR17 & HIR17/R)



### Permanent ON/OFF function

Press button "ON/OFF" to select permanent ON or permanent OFF mode.

\* Press button "AUTO", "RESET" or "Ambient" to quit this mode.

The mode will change to AUTO Mode after power failure.



### Reset Settings

Press button "RESET", all settings go back to default values (Tri-level Control mode).

Detection range: 100%; Hold-time: 5min; Stand-by period: 10min;

Stand-by dimming level: 10%; Lux disabled



### Shift Button

Press button "Shift", the LED on the top left corner is on to indicate mode selection.

All values / settings in RED are valid for 20 seconds.



### AUTO mode

Press button "AUTO" to initiate automatic mode. The sensor starts working and all settings remain as before the light is switched ON/OFF.

*Note: To initiate automatic mode under semi-auto mode, please press button "RESET" first.*



### SEMI-AUTO mode

1. Press button "Shift", the red LED flashes for indication.
2. Press button "SEMI-AUTO/AUTO" to initiate semi-auto mode. The fixture is manually turned on by pressing the push-switch, and goes off automatically after stand-by time. (Absence detection mode)



### Power output

Press the buttons to select light output at 80% (at initial 10,000 hours) or 100%.

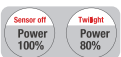

### Sensor off & Twilight

Press button "Shift", the red LED is on for indication. Press button "Twilight", the function of motion detection is disabled. The function of photocell is still working, and the product becomes a pure dusk / dawn daylight sensor. Press button "Sensor off", the function of motion detection is disabled. The function of photocell is also disabled.



### Switching between Tri-level and Daylight Harvest

Press button "Shift", the red LED is on for indication. Then press "Tri-level" or "Harvest" to switch.

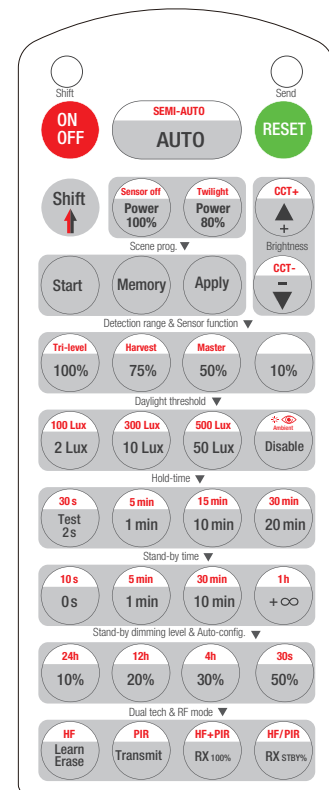

HRC-11



## Brightness +/-

For Tri-level control, press these two buttons to adjust the light output brightness. Press button "Shift", the red LED is on for indication. Press these two buttons to adjust the light output colour temperature.

For Daylight Harvest, press these two buttons to adjust the light output brightness and set a new target lux level. The daylight sensor can measure ambient daylight level and ignore the LED light, so as to calculate how much artificial light is needed to maintain the target lux level. Press button "Shift", the red LED is on for indication. Press these two buttons to adjust the light output colour temperature.



## Scene program - 1-key commissioning

1. Press button "Start" to program.
2. Select the buttons in "Detection range", "Daylight threshold", "Hold-time", "Stand-by time", "Stand-by dimming level" to set all parameters.
3. Press button "Memory" to save all the settings programmed in the remote control.
4. Press button "Apply" to set the settings to each sensor unit(s).

*For example, to set detection range 100%, daylight threshold Disable, hold-time 5min, stand-by time +∞, stand-by dimming level 30%, the steps should be: Press button "Start", button "100%", "Disable", "Shift", "5min", "Shift", "+∞", "30%", "Memory". By pointing to the sensor unit(s) and pressing "Apply", all settings are passed on the sensor(s).*

### Detection range

All buttons in this zone are disabled.



## Master (HCD038/P)

HIR17 supports multiple sensors to access DALI network at the same time. In order to prevent conflict during daylight harvest control, you need to manually select one HIR17 as the master when configuring the network. The master has the control authority of this DALI network. Other HIR17 will only report sensing events.

### Daylight threshold

Press buttons in zone "Daylight threshold" to set daylight sensor at 2Lux / 10Lux / 50Lux / 100Lux / 300Lux / 500Lux / Disable.

*Note: To set daylight sensor at 100Lux / 300Lux / 500Lux, press "Shift" button first.*

### Ambient daylight threshold

1. Press button "Shift", the red LED starts to flash.
2. Press button "Ambient", the surrounding lux level is sampled and set as the new daylight threshold.

### Hold-time

Press buttons in zone "hold-time" to set the hold-time at 2s / 30s / 1min / 5min / 10min / 15min / 20min / 30min.

*Note: 1. To set hold-time at 30s / 5min / 15min / 30min, press "Shift" button first.*

*2. 2s is for testing purpose only, stand-by period and daylight sensor settings are disabled in this mode.*

\*To exit from Test mode, press button "RESET" or any button in "Hold-time".

### Stand-by time (corridor function)

Press buttons in zone "stand-by time" to set the stand-by period at 0s / 10s / 1min / 5min / 10min / 30min / 1h / +∞.

*Note: "0s" means on/off control; "+∞" means the stand-by time is infinite and the fixture never switches off.*

### Stand-by dimming level

Press the button in zone "stand-by dimming level" to set the stand-by dimming level at 10% / 20% / 30% / 50%.

### Auto-configuration function

This is a function for Daylight Harvest mode, select a time period and the sensor will do light level measurement and determine / save the lowest light level (commission line) with 100% on, so as to automatically set the target lux level for daylight harvesting.

For Tri-level Control, All buttons in this zone are disabled.

### Dual tech & RF mode

All buttons in this zone are disabled.

## Additional Information / Documents

1. Regarding precautions for PIR sensor installation and operation, please kindly refer to [www.hytronik.com/download](http://www.hytronik.com/download) ->knowledge ->PIR Sensors - Precautions for Product Installation and Operation
2. Regarding precautions for Photodiode/Photocell Usages, please kindly refer to [www.hytronik.com/download](http://www.hytronik.com/download) ->knowledge ->Precautions for Photodiode/Photocell Usages
3. Data sheet is subject to change without notice. Please always refer to the most recent release on [www.hytronik.com/products/Motion Sensors](http://www.hytronik.com/products/Motion%20Sensors) ->Built-in HF Sensor
4. Regarding Hytronik standard guarantee policy, please refer to [www.hytronik.com/download](http://www.hytronik.com/download) ->knowledge ->Hytronik Standard Guarantee Policy