

Detached Motion Sensor with  Bluetooth® 5.0 SIG Mesh

HC038V  
1-10V Output

HCD038  
DALI Output

HCD038/P

**HYTRONIK**®



### Product Description

HC038V is a 1-10V control base whereas HCD038 and HCD038/P are DALI control bases with different DALI power supply built in. They work with a wide range of microwave and PIR sensor heads. They are ideal for metal luminaire designs because the Bluetooth module is placed inside the sensor heads instead of control base, so that the Bluetooth signal transmission is viable. They are suitable for any typical indoor applications such as office, classroom, car park, warehouse and other commercial/industrial areas. With Bluetooth wireless mesh networking, it makes communication much easier without any hardwiring, which eventually adds values to luminaires and saves costs for projects. Meanwhile, simple device setup and commissioning can be done via **Koolmesh**® app.

































HC038V

HCD038









HCD038/P

### App Features





-  Quick setup mode & advanced setup mode
-  Web app/platform for project deployment & data analysis
-  Koolmesh Pro app on iPad for on-site configuration
-  Floorplan feature to simplify project planning
-  DALI-2 supported coming soon
-  One-key device replacement
-  Device social relations check
-  Staircase function (primary & secondary)
-  Remote control via gateway support HBGW01
-  Heat map
-  Dynamic daylight harvest auto-adaptation
-  Grouping luminaires via mesh network
-  Scenes
-  Dusk/Dawn photocell (Twilight function)
-  Tri-level control
-  Daylight harvest
-  Push switch configuration
-  Detailed motion sensor settings
-  Schedule
-  Astro timer (sunrise and sunset)
-  Power-on status (memory against power loss)
-  Offline commissioning
-  Bulk commissioning (copy and paste settings)
-  Different permission levels via authority management
-  Network sharing via QR code or keycode
-  Interoperability with Hytronik Bluetooth product portfolio

-  Compatible with EnOcean BLE switches
-  Internet-of-Things (IoT) featured
-  Device firmware update over-the-air (OTA)
-  Continuous development in progress...





### Hardware Features

-  HC038V: 1-10V output with 400VA (capacitive) & 800W (resistive)
-  DALI bus power supply: (HCD038/P)  
I max: 80mA  
U rated: 1.5VDC  
I guaranteed: 64mA
-  Plug'n'Play for flexible installation and cost saving assemble
-  Support to control DT8 LED drivers (HCD038 and HCD038/P)
-  2 Push inputs for flexible manual control (HCD038/P only)
-  Zero crossing detection circuit to reduce in-rush current and prolong relay lifetime (HC038V only)
-  Loop-in and loop-out terminals for efficient installation (HC038V only)
-  5-year warranty

 Bluetooth® Kinetic Switch









				
HBKS01	HBKS02	HBKS03	HBKS01D	HBKS02D

---

			
---	---	--	---

Fully support EnOcean self-powered switch module  
PTM215B (HBES01/W & HBES01/B)

 Bluetooth 5.0 SIG mesh

			
Smartphone app for both iOS & Android platform			
			
Koolmesh Pro app for iPad			
			
Web app/platform: <a href="http://www.iot.koolmesh.com">www.iot.koolmesh.com</a>			

## Technical Specifications

Input & Output Characteristics	
Operating voltage	220~240VAC 50/60Hz
Stand-by power	<0.5W
Load ratings:	
HC038V	400VA (capacitive) 800W (resistive)
HCD038	max.30mA
HCD038/P	DALI bus power supply: I max:80mA U rated:15VDC I guranteed:64mA
Warming-up	20s

Safety & EMC	
EMC standard (EMC)	EN55015, EN61000, EN61547
Safety standard (LVD)	EN60669-1/-2-1, AS/NZS60669-1/-2-1
Radio Equipment (RED)	EN300440, EN301489-1/-3/-17 EN62479, EN300328
Certification	Semko, CB, CE, EMC, RED, RCM

Environment	
Operation temperature	Ta: -20°C ~ +55°C
Case temperature (Max.)	Tc: +75°C
IP rating	IP20

## Mechanical Structure & Dimensions

HC038V (1-10V output with 1 push)

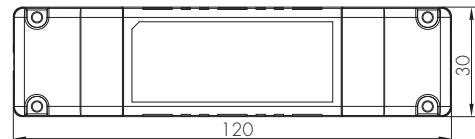
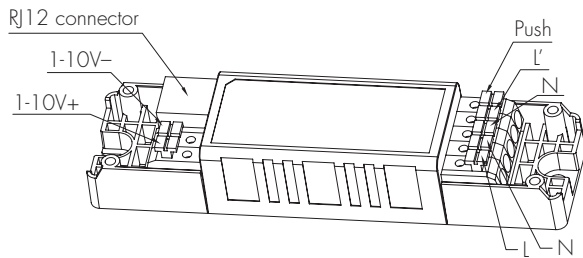

HCD038 (DALI output with 1 push)

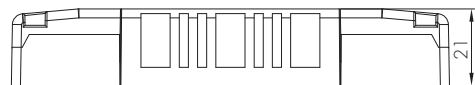
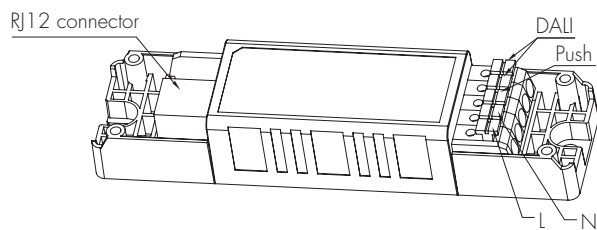

HCD038/P (DALI output with 2 push)

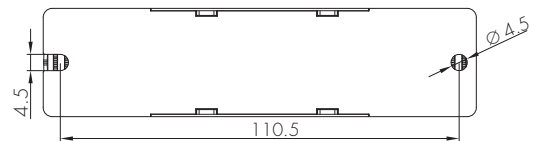
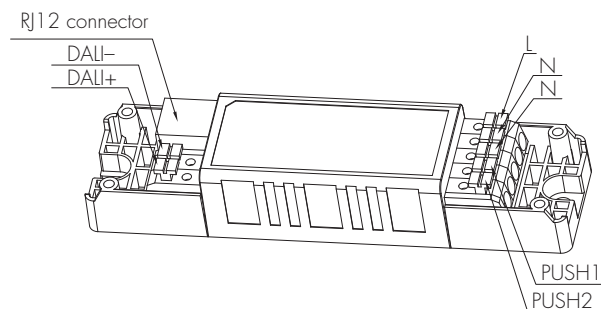

## Wire Preparation

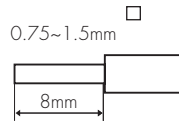
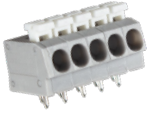

To make or release the wire from the terminal, use a screwdriver to push down the button.

1. 200 metres (total) max. for 1mm<sup>2</sup> CSA (Ta = 50°C)
2. 300 metres (total) max. for 1.5mm<sup>2</sup> CSA (Ta = 50°C)

## Wiring Diagram

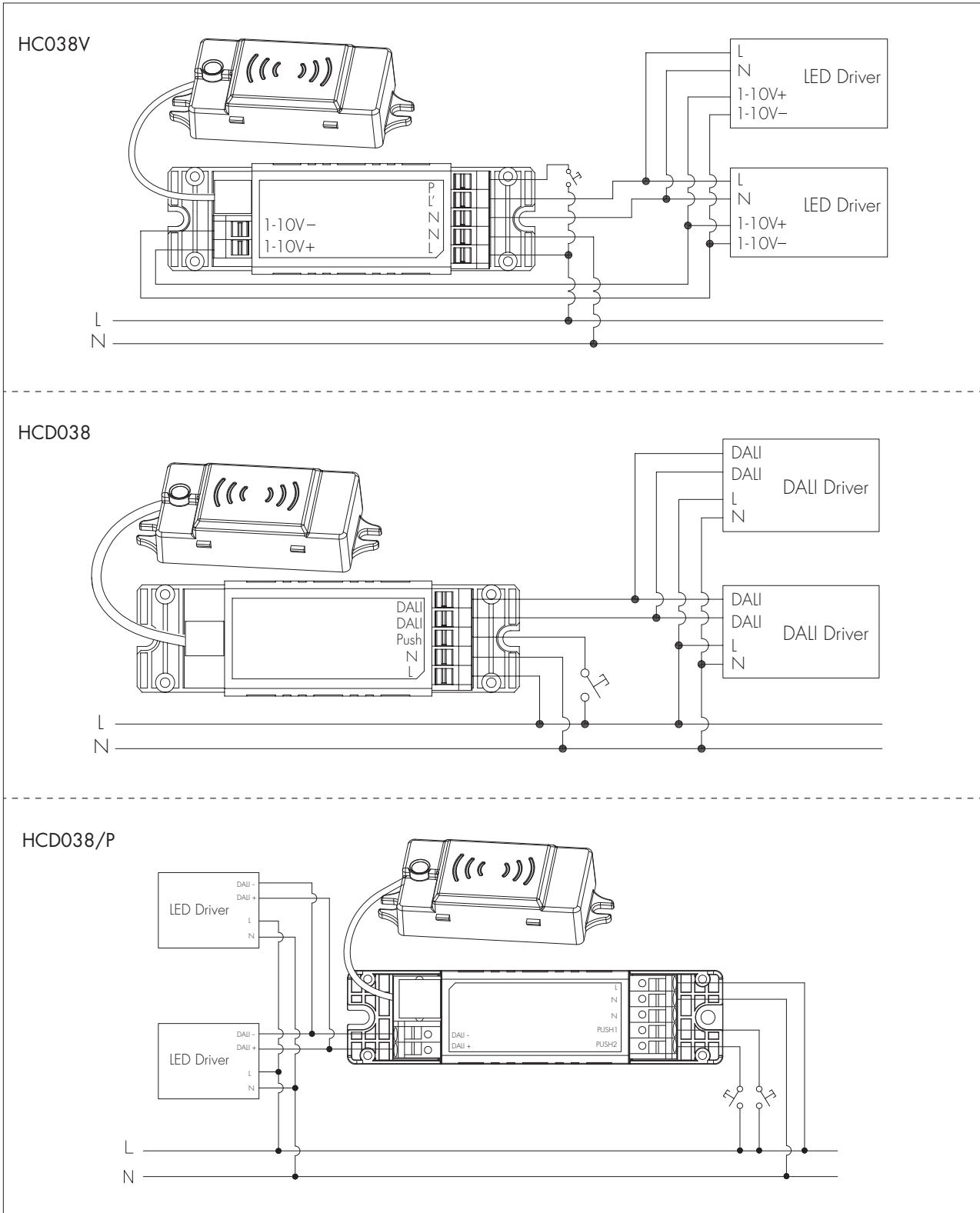

## Technical Specifications for Sensor Heads

Bluetooth Transceiver	
Operation frequency	2.4 GHz - 2.483 GHz
Transmission power	4 dBm
Range (Typical indoor)	10~30m
Protocol	 Bluetooth® 5.0 SIG Mesh

Environment	
Operation temperature	Ta: -20°C ~ +55°C
Storage temperature	-20°C ~ +70°C
Relative humidity	0 ~ 90%
IP rating	IP20

HF Sensor Properties (HBT01)	
Sensor principle	High Frequency (microwave)
Operation frequency	5.8GHz +/- 75MHz
Transmission power	<0.2mW
Detection range*	Max installation height: 3m Max detection range (Ø): 8m
Detection angle	30° ~ 150°

PIR Sensor Properties (HIR13 & HIR16 & HIR62 & HIR62/R)		
Sensor principle	PIR detection	
Operation voltage	5VDC	
Detection range *	HIR13 Max installation height: 15m (forklift) 12m (single person) Max detection range (Ø): 24m	
	HIR16 Max installation height: 15m (forklift) 12m (single person) Max detection range: 18m * 6m (L * W)	
	HIR62 Max installation height: 3m (single person) Max detection range (Ø): 12m	
	HIR62/R Max installation height: 8m (single person) Max installation height: 12m (forklift) Max detection range (Ø): 14m	
	Detection angle	360°

\* The detection range is heavily influenced by sensor placement (angle) and different walking paces. It may be reduced under certain conditions.

## PIR & microwave sensor heads

The range of PIR and microwave sensor heads below with Bluetooth modules built in offers powerful number of Plug'n'Play feature options to expand the flexibility of luminaire design. This approach to luminaire design reduces space requirements and component costs whilst simplifying production.

### A. HBT01

Surface mounting  
Photocell Advance™  
The cable length is around 30cm.

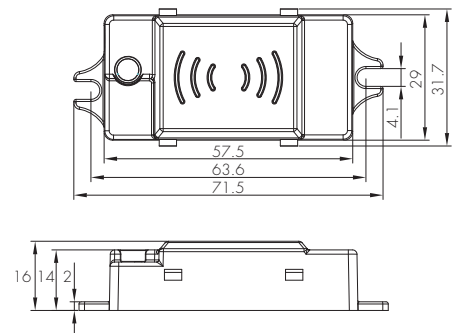
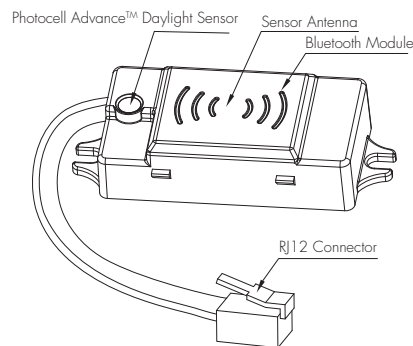

### B. HBT02

Surface mounting  
Without motion sensor  
Photocell Advance™  
The cable length is around 30cm.

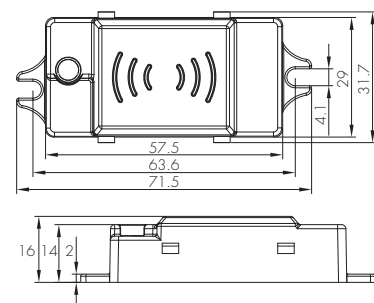
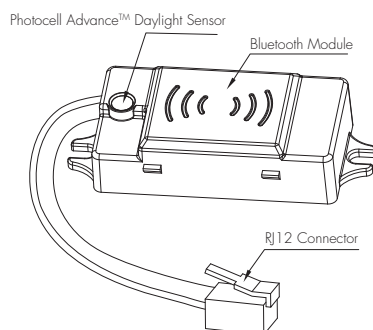

### C. HIR13/S

Surface mounting  
 For highbay application  
 IP65 (facia / lens part)  
 The cable length is around 30cm.

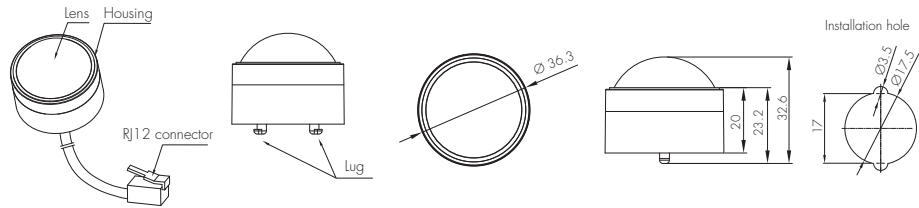

### D. HIR13/F

Flush mounting  
 For highbay application  
 IP65 (facia / lens part)  
 The cable length is around 30cm.

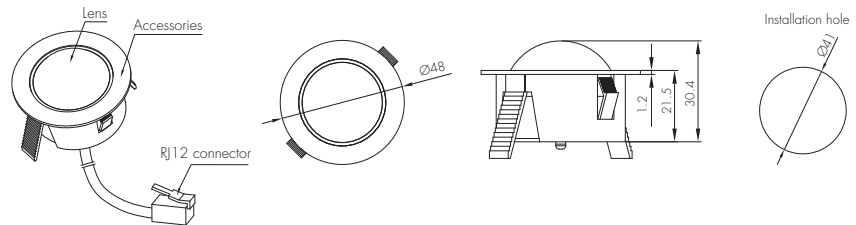

### E. HIR13/C

Screw to the luminaire by conduit  
 For highbay application  
 IP65 (facia / lens part)  
 The cable length is around 30cm.

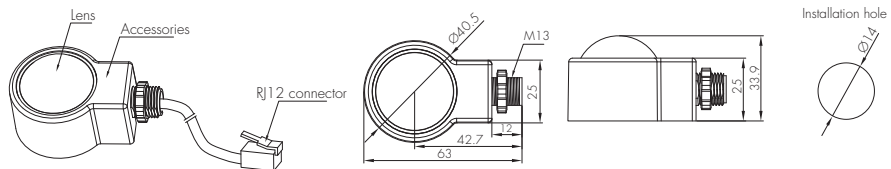

### F. HIR13/AA

PIR sensor head  
 Adjustable angle  
 The cable length is around 30cm.

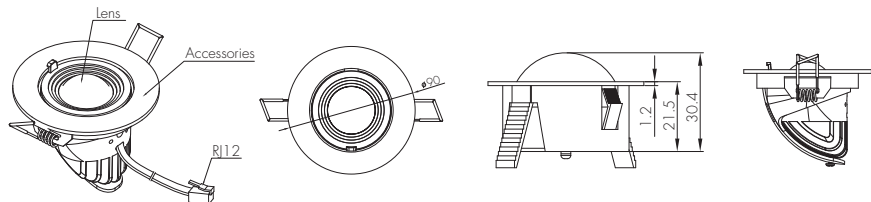

### G. HIR16

PIR sensor head  
 Keep real time for up to 2 weeks  
 against power failure  
 For highbay application  
 IP65 (facia / lens part)  
 The cable length is around 30cm.

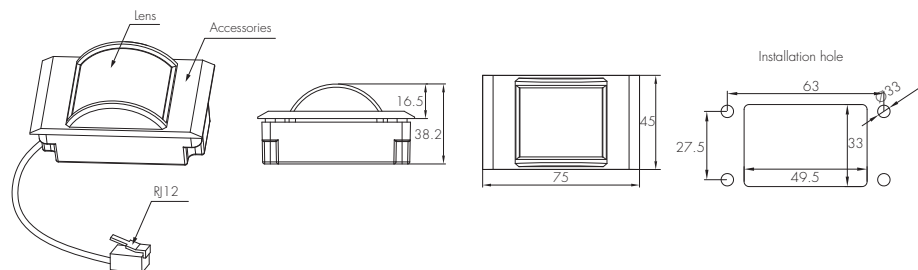

### Installation for HIR16



We suggest that the metal plate thickness to be 0.8mm – 1.6mm to ensure perfect focal length for the PIR lens.

### H. HIR62

PIR sensor head  
The cable length is around 30cm.

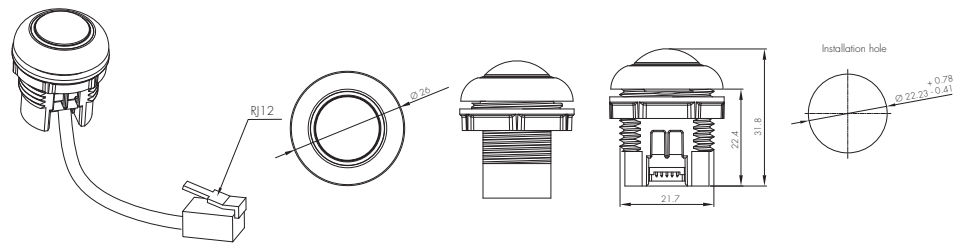

### I. HIR62 with HA04

PIR sensor head  
Optional accessory  
The cable length is around 30cm.

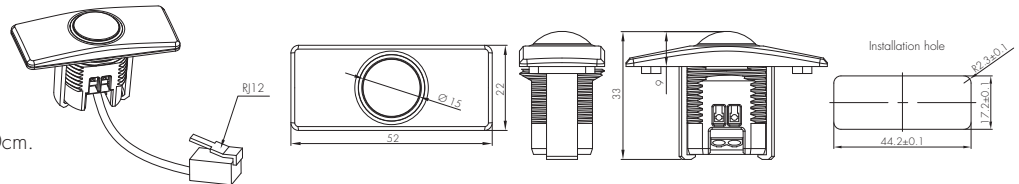

### J. HIR62 with HA05

PIR sensor head  
Optional accessory  
The cable length is around 30cm.

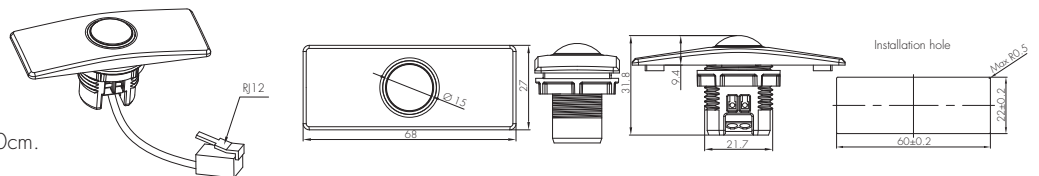

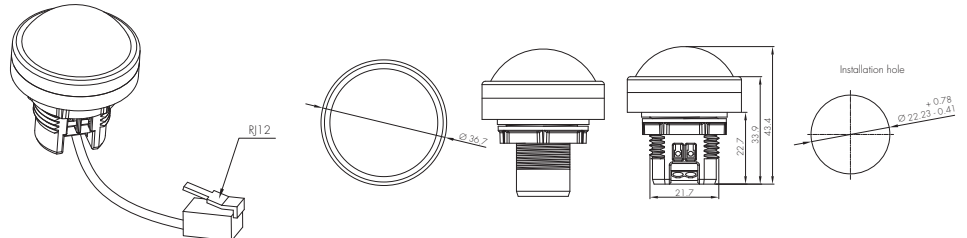

### K. HIR62/R

PIR sensor head  
IP65 (facia / lens part)  
The cable length is around 30cm.

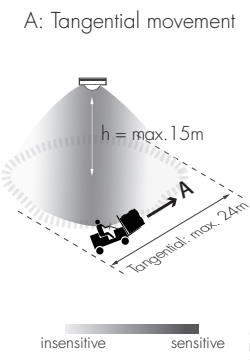
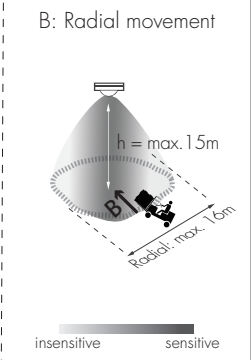

Note: When HIR62 or HIR62/R plug with HCD038/P, only one push terminal can be activated for configuration.

Detection Pattern

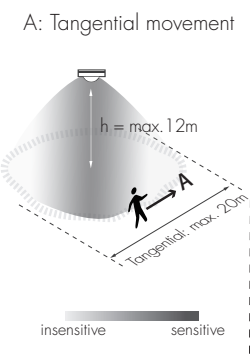
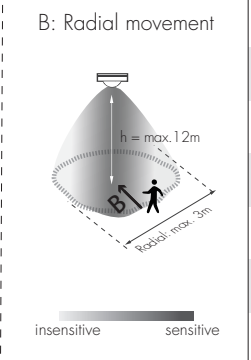
HIR13 (High-bay)				
		<p><b>HIR13: High-bay lens detection pattern for <u>forklift</u> @ Ta = 20°C</b>                      (Recommended installation height <b>10m-15m</b>)</p>		
<p>A: Tangential movement</p> 	<p>B: Radial movement</p> 	Mount height	Tangential (A)	Radial (B)
		10m	max 380m <sup>2</sup> (Ø = 22m)	max 201m <sup>2</sup> (Ø = 16m)
		11m	max 452m <sup>2</sup> (Ø = 24m)	max 201m <sup>2</sup> (Ø = 16m)
		12m	max 452m <sup>2</sup> (Ø = 24m)	max 201m <sup>2</sup> (Ø = 16m)
		13m	max 452m <sup>2</sup> (Ø = 24m)	max 177m <sup>2</sup> (Ø = 15m)
		14m	max 452m <sup>2</sup> (Ø = 24m)	max 133m <sup>2</sup> (Ø = 13m)
		15m	max 452m <sup>2</sup> (Ø = 24m)	max 113m <sup>2</sup> (Ø = 12m)
		<p><b>HIR13: High-bay lens detection pattern for <u>single person</u> @ Ta = 20°C</b>                      (Recommended installation height <b>2.5m-12m</b>)</p>		
<p>A: Tangential movement</p> 	<p>B: Radial movement</p> 	Mount height	Tangential (A)	Radial (B)
		2.5m	max 50m <sup>2</sup> (Ø = 8m)	max 7m <sup>2</sup> (Ø = 3m)
		6m	max 104m <sup>2</sup> (Ø = 11.5m)	max 7m <sup>2</sup> (Ø = 3m)
		8m	max 154m <sup>2</sup> (Ø = 14m)	max 7m <sup>2</sup> (Ø = 3m)
		10m	max 227m <sup>2</sup> (Ø = 17m)	max 7m <sup>2</sup> (Ø = 3m)
		11m	max 269m <sup>2</sup> (Ø = 18.5m)	max 7m <sup>2</sup> (Ø = 3m)
		12m	max 314m <sup>2</sup> (Ø = 20m)	max 7m <sup>2</sup> (Ø = 3m)

### HIR16

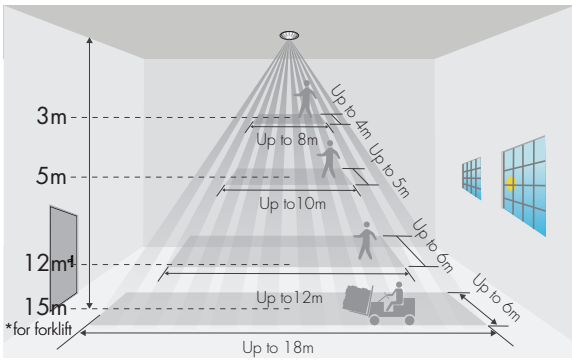

\*The detection patterns are based upon 5km/h movement speed.

### HIR62

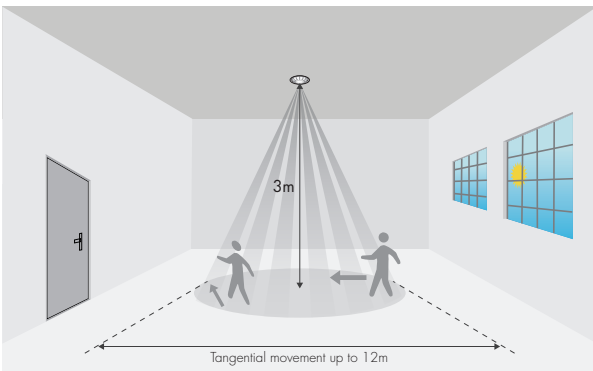

### HIR62/R

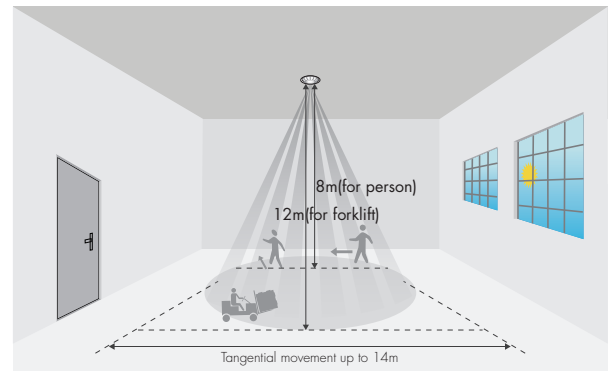

\*The detection patterns are based upon 5km/h movement speed.

### HBT01

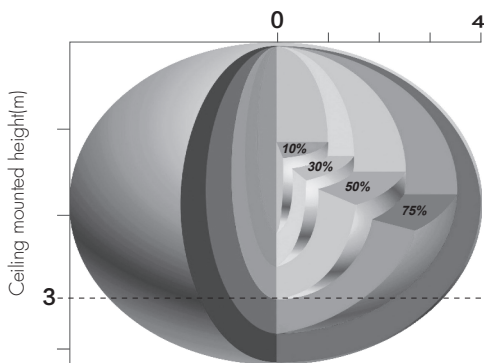

The detection range is heavily influenced by sensor placement (angle) and different walking paces.

It may be reduced to 2m(diameter) & 3m(height) under certain conditions (walking across).



## Dimming Interface Operation Notes

### Switch-Dim

The provided Switch-Dim interface allows for a simple dimming method using commercially available non-latching (momentary) wall switches. Detailed Push switch configurations can be set on Koolmesh app.

Switch Function	Action	Descriptions
Push switch	Short press (<1 second) * Short press has to be longer than 0.1s, or it will be invalid.	- Turn on/off - Turn on only - Turn off only - Recall a scene - Quit manual mode - Do nothing
	Double push	- Turn on only - Turn off only - Recall a scene - Quit manual mode - Do nothing
	Long press (≥1 second)	- Dimming - Colour tuning - Do nothing
Sensor-link	/	- Upgrade a normal on/off motion sensor to a Bluetooth controlled motion sensor
Emergency Self-Test Function	Short press (<1 second) * Short press has to be longer than 0.1s, or it will be invalid.	- Start Self test (Monthly) - Stop Self test - Start Self test (Annually) - Invalid
	Long press (≥1 second)	- Start Self test (Monthly) - Stop Self test - Start Self test (Annually) - Invalid
Fire Alarm (VFC signal only)	Refer to <b>Koolmesh</b> ® App User Manual V2.1	- Able to connect the Fire Alarm system - Once the fire alarm system is triggered, all the luminaries controlled by the Push Switch will enter the preset scene (normally it's full on), after the fire alarm system gives the ending signal, all the luminaries controlled by this Push Switch will revert back to normal status.

## Additional Information / Documents

- For full explanation of Hytronik Photocell Advance™ technology, please kindly refer to [www.hytronik.com/download ->knowledge ->Introduction of Photocell Advance](http://www.hytronik.com/download->knowledge->Introduction%20of%20Photocell%20Advance)
- To learn more about detailed product features/functions, please refer to [www.hytronik.com/download ->knowledge ->Introduction of App Scenes and Product Functions](http://www.hytronik.com/download->knowledge->Introduction%20of%20App%20Scenes%20and%20Product%20Functions)
- Regarding precautions for Bluetooth product installation and operation, please kindly refer to [www.hytronik.com/download ->knowledge ->Bluetooth Products - Precautions for Product Installation and Operation](http://www.hytronik.com/download->knowledge->Bluetooth%20Products%20-%20Precautions%20for%20Product%20Installation%20and%20Operation)
- Regarding precautions for microwave sensor installation and operation, please kindly refer to [www.hytronik.com/download ->knowledge ->Microwave Sensors - Precautions for Product Installation and Operation](http://www.hytronik.com/download->knowledge->Microwave%20Sensors%20-%20Precautions%20for%20Product%20Installation%20and%20Operation)
- Regarding precautions for PIR Sensors installation and operation, please kindly refer to [www.hytronik.com/download ->knowledge ->PIR Sensors - Precautions for Product Installation and Operation](http://www.hytronik.com/download->knowledge->PIR%20Sensors%20-%20Precautions%20for%20Product%20Installation%20and%20Operation)
- Data sheet is subject to change without notice. Please always refer to the most recent release on [www.hytronik.com/products/bluetooth technology ->Bluetooth Sensors](http://www.hytronik.com/products/bluetooth%20technology->Bluetooth%20Sensors)
- Regarding Hytronik standard guarantee policy, please refer to [www.hytronik.com/download ->knowledge ->Hytronik Standard Guarantee Policy](http://www.hytronik.com/download->knowledge->Hytronik%20Standard%20Guarantee%20Policy)