

PIR Standalone Motion Sensor with Bluetooth® NLC

HBIR29/NLC	HBIR29/NLC/R	HBIR29/NLC
Low-bay	Reinforced Low-bay	High-bay

HYTRONIK®

   CB RED  

Product Description

HBIR29/NLC is a Bluetooth PIR standalone motion sensor. It is ideal for typical indoor applications such as office, classroom, healthcare and other commercial areas. Meanwhile, all commissioning and settings can be done via SILVAIR app.



HBIR29/NLC



HBIR29/NLC/R



HBIR29/NLC/H

Functions and Features

- Bluetooth® NLC compliant
- Surface mount kit available as accessory
- PIR occupancy detection with 2 types of blind inserts / blanking plates
- Compact form factor
- Autonomous sensor-based control
- OTA firmware upgrade
- Individual/group addressing
- Decentralized control (no single point of failure)
- User-friendly design for installation
- High bay version available (up to 1.5m in height)
- 5-years warranty



The access to SilvaIR apps

mobile app: [SilvaIR on the App Store](#)

web app: platform.silva.ir.com

Technical Specifications

Bluetooth Transceiver	
Operation frequency	2.4 GHz - 2.483 GHz
Transmission power	4 dBm
Range (Typical indoor)	10~30m
Protocol	 Bluetooth® NLC

Input & Output Characteristics	
Operating voltage	220~240VAC 50/60Hz
Max input current	10mA
Stand-by power	<0.65W (Empty load)
Switched power	Max. 40 devices, 80mA
Warming-up	5s
Life span	50,000h@Tc=60°C
Tc max	60°C
Lux range	1-1,000lux Tolerance +/- 20%

Sensor Data	
Sensor Model	PIR max* detection range
HBIR29/NLC	Installation Height : 6m Detection Range(Ø) : 9m
HBIR29/NLC/R	Installation Height : 6m Detection Range(Ø) : 10m
HBIR29/NLC/H	Installation height: 1.5m (forklift) 1.2m (person) Detection range (Ø): 24m
Detection angle	360°
Standard compliance	EN300328, EN301489-1, EN301489-17, EN62479, EN55015, EN61547, EN60669-1, EN60669-2-1, EN62493

* For more details of detection range, please refer to "detection pattern" section.

Environment	
Operation temperature	Ta: -20°C ~ +50°C
Operation humidity (RH%)	10%~90% (Non-condensing)
Storage temperature (°C)	-40°C~+70°C
Storage humidity (RH%)	10%~90% (Non-condensing)
IP rating	IP20
IP rating (facial part)	IP54

*IP54 (facial part) only for lens of standard, /R, /H.

Mechanical Structure & Dimensions

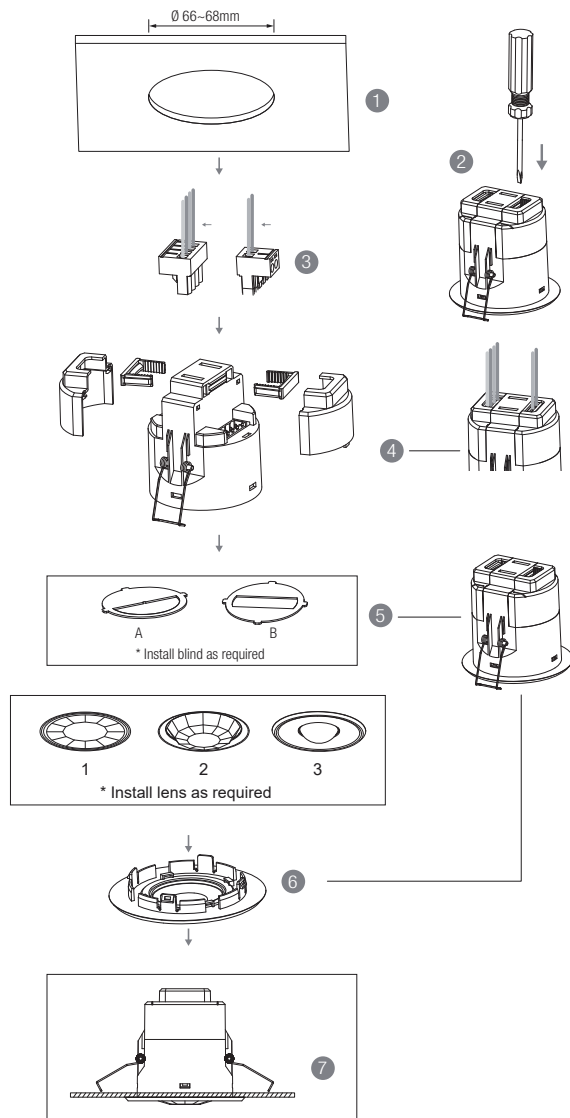

1. Ceiling (drill hole \varnothing 66~68mm)
2. Carefully prise off the cable clamps.
3. Make connections to the pluggable terminal blocks.
4. Insert plug connectors and secure using the provided cable clamps, then clip terminal covers to the base.
5. Fit detection blind (if required) and desired lens.
6. Clip fascia to body.
7. Bend back springs and insert into ceiling.

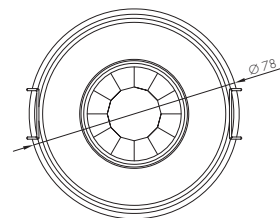

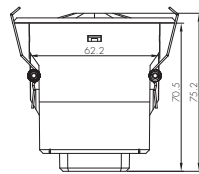

HBR29/NLC

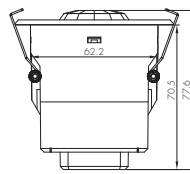

HBR29/NLC/R

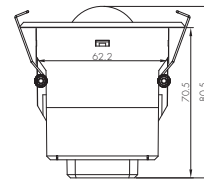

HBR29/NLC/H

Wiring Diagram

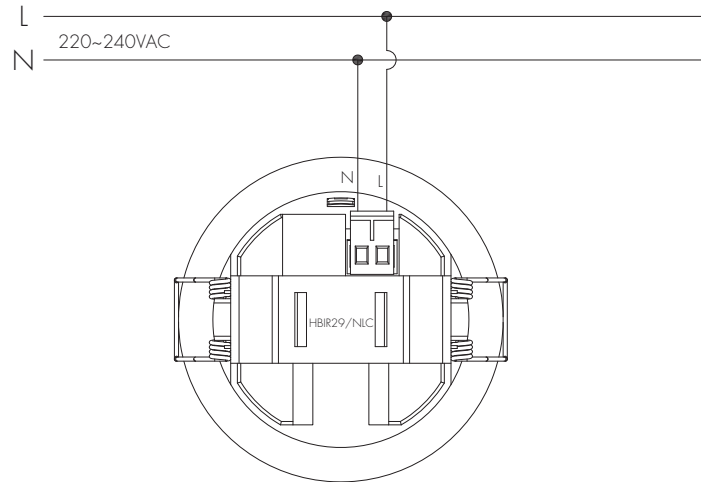

Wire Preparation

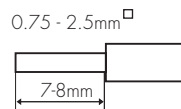

Pluggable screw terminal. It is recommended to make connections to the terminal before fitting to the sensor.

Supported Bluetooth Mesh Models

Placement Guide and Typical Range

Smart Phone to Device Range

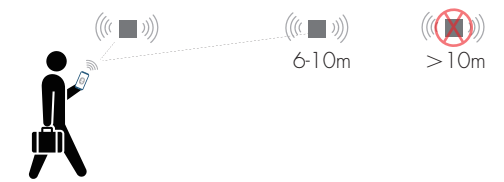

The smart device with the App installed will have a typical range of 10m, but varies from device to device. During commissioning, the installer will need to be in range of the devices when searching for devices to add to the network.

Once the devices have been added to the network via the App, the devices will start communicating within the wireless mesh. This means that once the network is complete, all devices are accessible from the smart device when in a 20m range of a single point.

Optional Accessories For Water-Proof

Big and small silicon gasket used to make IP54 degree protection (mounted into HA09 housing for ceiling mount)

Small silicon water-proof gasket dimension(size:mm)

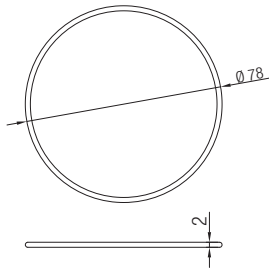

Big silicon water-proof gasket dimension(size:mm)

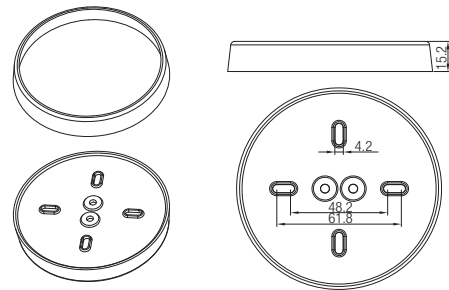

Detection Pattern & Optional Accessories

1. HBR29/NLC (Low-bay)



HBR29/NLC: Low-bay flat lens detection pattern for single person @ Ta = 20°C

(Recommended ceiling mount installation height **2.5m-6m**)

A: Tangential movement	B: Radial movement	Mount height	Tangential (A)	Radial (B)
		2.5m	max 50m ² (Ø = 8m)	max 13m ² (Ø = 4m)
		3m	max 64m ² (Ø = 9m)	max 13m ² (Ø = 4m)
		4m	max 38m ² (Ø = 7m)	max 13m ² (Ø = 4m)
		5m	max 38m ² (Ø = 7m)	max 13m ² (Ø = 4m)
		6m	max 38m ² (Ø = 7m)	max 13m ² (Ø = 4m)

Optional Accessory --- Ceiling/Surface Mount Box: HA09

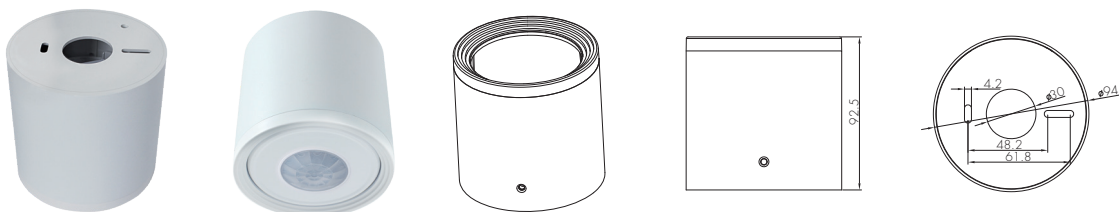

Optional Accessory --- Blind Insert for Blocking Certain Detection Angles

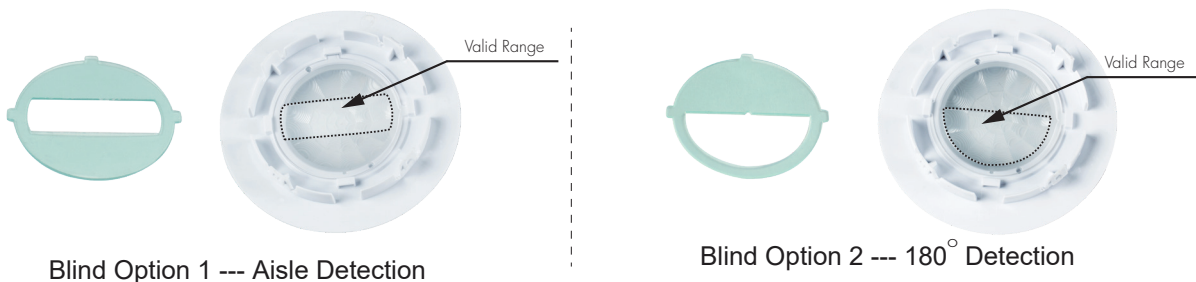

Blind Option 1 --- Aisle Detection

Blind Option 2 --- 180° Detection

2. HBIR29/NLC/R (Reinforced Low-bay)



HBIR29/NLC/R: Low-bay convex lens detection pattern for **single person** @ $T_a = 20^\circ\text{C}$

(Recommended ceiling mount installation height **2.5m-6m**)

A: Tangential movement	B: Radial movement	Mount height	Tangential (A)	Radial (B)
		2.5m	max 79m ² (∅ = 10m)	max 20m ² (∅ = 5m)
		3m	max 79m ² (∅ = 10m)	max 20m ² (∅ = 5m)
		4m	max 64m ² (∅ = 9m)	max 20m ² (∅ = 5m)
		5m	max 50m ² (∅ = 8m)	max 20m ² (∅ = 5m)
		6m	max 50m ² (∅ = 8m)	max 20m ² (∅ = 5m)

Optional Accessory --- Ceiling/Surface Mount Box: HA09

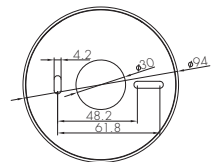
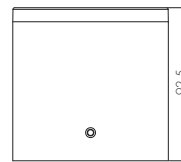
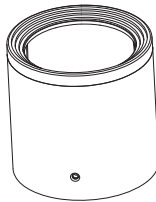

Optional Accessory --- Blind Insert for Blocking Certain Detection Angles

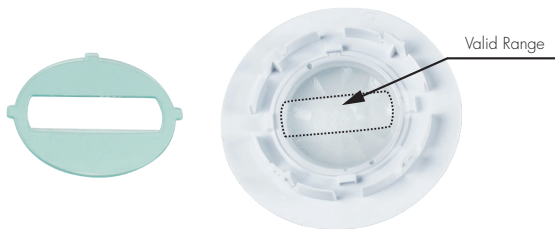

Blind Option 1 --- Aisle Detection

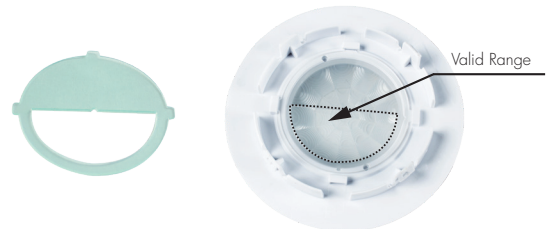

Blind Option 2 --- 180° Detection

3. HBIR29/NLC/H (High-bay)



HBIR29/NLC/H: High-bay lens detection pattern for forklift @ Ta = 20°C

(Recommended ceiling mount installation height **10m-15m**)

A: Tangential movement	B: Radial movement	Mount height	Tangential (A)	Radial (B)
		10m	max 380m ² (Ø = 22m)	max 201m ² (Ø = 16m)
		11m	max 452m ² (Ø = 24m)	max 201m ² (Ø = 16m)
		12m	max 452m ² (Ø = 24m)	max 201m ² (Ø = 16m)
		13m	max 452m ² (Ø = 24m)	max 177m ² (Ø = 15m)
		14m	max 452m ² (Ø = 24m)	max 133m ² (Ø = 13m)
		15m	max 452m ² (Ø = 24m)	max 113m ² (Ø = 12m)



HBIR29/NLC/H: High-bay lens detection pattern for single person @ Ta = 20°C

(Recommended ceiling mount installation height **2.5m-12m**)

A: Tangential movement	B: Radial movement	Mount height	Tangential (A)	Radial (B)
		2.5m	max 50m ² (Ø = 8m)	max 7m ² (Ø = 3m)
		6m	max 104m ² (Ø = 11.5m)	max 7m ² (Ø = 3m)
		8m	max 154m ² (Ø = 14m)	max 7m ² (Ø = 3m)
		10m	max 227m ² (Ø = 17m)	max 7m ² (Ø = 3m)
		11m	max 269m ² (Ø = 18.5m)	max 7m ² (Ø = 3m)
		12m	max 314m ² (Ø = 20m)	max 7m ² (Ø = 3m)

Optional Accessory -- Ceiling/Surface Mount Box: HA09

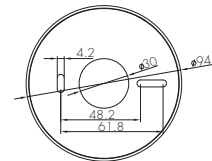
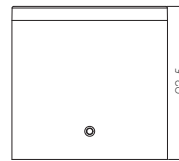
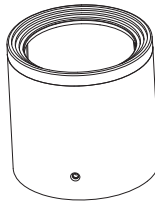

Optional Accessory -- Blind Insert for Blocking Certain Detection Angles

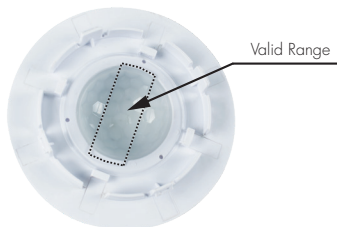

Blind Option 1 --- Aisle Detection

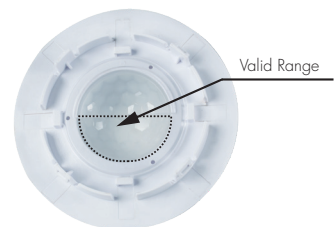

Blind Option 2 --- 180° Detection

Mesh Factory Reset

The device HBIR29/NLC can be reset by placing a strong magnet (e.g. N38 neodymium magnet, d=10mm*h=4mm) near the sensor lens for 5 seconds. Once the factory reset is done successfully, the luminaire flashes and then permanent on, then the device is being able to be re-commissioned by SILVAIR app.

To Reprovision

Place a strong magnet on the site of the Reset/Hall effect sensor (see diagram 4 below). To trigger the reset the magnet must be held in position for 5 seconds.

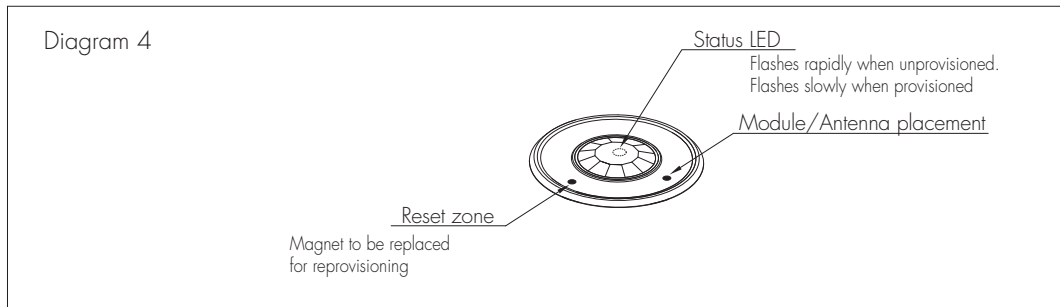

Note: When change the lens part of HBIR29/NLC, please kindly make sure that the lens fits the right location, where the "Reset dot" and "BLE dot" matches with the physical location on the PCB.

Status LED blinking Sequence		
HBIR29/NLC Unprovisioned	30ms ON	300ms OFF
HBIR29/NLC Provisioned	15ms ON	2,000ms OFF
Factory reset	500ms ON	1,000ms OFF
Factory reset (initial burst)	100ms ON	1,000ms OFF
MESH package received	30ms ON	50ms OFF
Attention (from network)	500ms ON	500ms OFF

Additional Information / Documents

1. Regarding precautions for PIR Sensors installation and operation, please kindly refer to [www.hytronik.com/download ->knowledge ->PIR Sensors - Precautions for Product Installation and Operation](http://www.hytronik.com/download->knowledge->PIR%20Sensors%20-%20Precautions%20for%20Product%20Installation%20and%20Operation)
2. Data sheet is subject to change without notice. Please always refer to the most recent release on [www.hytronik.com/products/bluetooth technology ->Partnership](http://www.hytronik.com/products/bluetooth%20technology->Partnership)
3. Regarding Hytronik standard guarantee policy, please refer to [www.hytronik.com/download ->knowledge ->Hytronik Standard Guarantee Policy](http://www.hytronik.com/download->knowledge->Hytronik%20Standard%20Guarantee%20Policy)