

HBEM05

For DALI dimmable driver, Self-Test

HYTRONIK®

























Product Description



HBEM05 is a Bluetooth Emergency module designed for DALI dimmable drivers with a maximum output power of 4W. It features an RJ12 connection for Hytronik optional sensor heads including SAM20, SAM21, SAM22, SAM23, HIRO5, HIRO5/FM, HIRO7, HIR11 series, HIR12, and HIR63 series.

With the HBGW02 gateway, users can conveniently generate emergency testing reports via our app. Additionally, HBEM05 offers automated monthly or annual testing and sends email notifications upon detecting faults. The device setup and commissioning process is streamlined and easily managed through the **Koolmesh**® app.







App Features







-  Quick setup mode & advanced setup mode
-  Web app/platform for project deployment & data analysis
-  Koolmesh Pro app on iPad for on-site configuration
-  Floorplan feature to simplify project planning
-  Emergency report generation and diagnosis
-  One-key device replacement
-  Device social relations check
-  Staircase function (primary & secondary)
-  Remote control via gateway support HBGW01
-  Grouping luminaires via mesh network
-  Scenes
-  Dusk/Dawn photocell (Twilight function)
-  Tri-level control
-  Daylight harvest
-  Circadian rhythm (Human centric lighting)
-  Push switch configuration
-  Detailed motion sensor settings
-  Schedule
-  Astro timer (sunrise and sunset)
-  Power-on status (memory against power loss)
-  Offline commissioning
-  Bulk commissioning (copy and paste settings)
-  Different permission levels via authority management
-  Network sharing via QR code or keycode
-  Interoperability with Hytronik Bluetooth product portfolio
-  Compatible with EnOcean BLE switches

-  Internet-of-Things (IoT) featured
-  Device firmware update over-the-air (OTA)
-  Continuous development in progress...

Hardware Features

-  Open-circuit Protection
-  Short-circuit Protection
-  Overload Protection
-  5-year warranty

Emergency Features

-  Emergency wattage: 6W/8W/10W/12W
-  Emergency working mode:
 - Normal emergency mode
 - Rest mode
 - Inhibit mode
 - Extended emergency mode
-  Monthly/Annually Automatic Testing with report generation
-  Battery status check via Koolmesh app
-  Automatic email notification when fault is detected
-  Retrievable usage data and report history

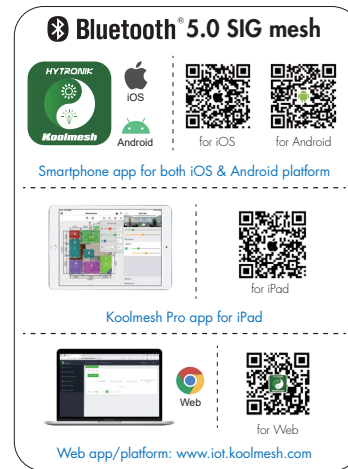
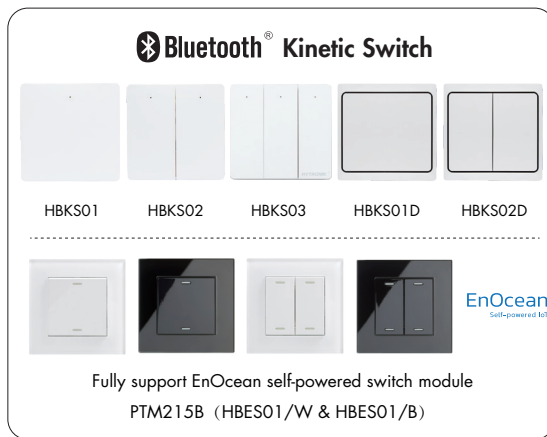

Technical Specifications

Bluetooth Transceiver	
Operation frequency	2.4 GHz - 2.483 GHz
Transmission power	4 dBm
Range (Typical indoor)	10~30m
Protocol	Bluetooth[®] 5.0 SIG Mesh

Emergency power selection

12W	● ● ● ●	●
10W	● ● ● ○	○
8W	● ● ○ ○	○
6W	○ ○ ○ ○	○
	1 2 3	○

Model No.		HBEM05
Input	Mains voltage	220~240VAC 50/60Hz
	Mains current	50mA (MAX)
	Max. loading	6W
	Efficiency	max. 85%
Output	Max. emergency output power	12W max.
	Output voltage(U-out Max.)	<20V Load LED voltage 60V
	Power factor	>0.7
Battery	Battery charge current	0 - 500mA
	Battery pack	BPC85
	Battery Type (LiFePO4) / Discharge current / Max. load / Discharge hour	12.8V,3.4AH/0.6A,6W@24-55V/180min 12.8V,3.4AH/0.8A,8W@24-55V/180min 12.8V,3.4AH/1A,10W@24-55V/180min 12.8V,4.5AH/1.2A,12W@24-55V/180min
	Battery abnormal protection	Short circuit protection
		Reverse connection protection
		Deep discharge
Charge period	24h	
Safety and EMC	EMC standard	EN55015, EN61547, EN61000-3-2, EN61000-3-3, EN300328; EN301489-17
	Safety standard	EN61347-1, EN62493, EN61347-2-7, EN62034, IEC62133
	Certifications	CE, UKCA, RCM, ROHS
	Abnormal protection	Output short-circuit protection, Overload Protection, Opencircuit Protection
Environment	Operation temperature	0~+50°C
	Storage temperature	-10~+45°C
	Relative humidity	20~90%
	Max. case temp.	80°C
	IP grade	IP20

Mechanical Structure & Dimensions

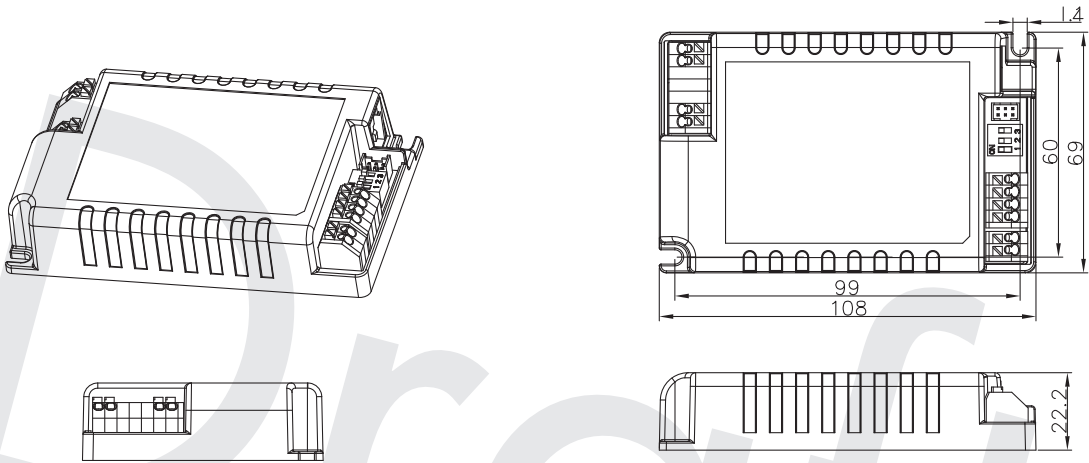
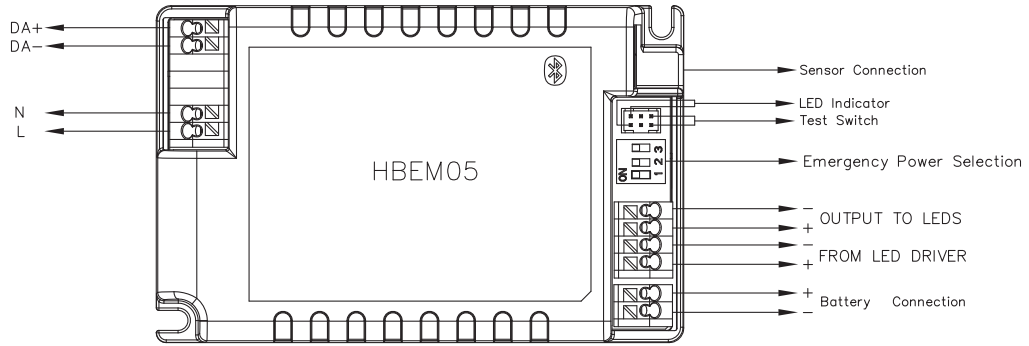

Wire Preparation

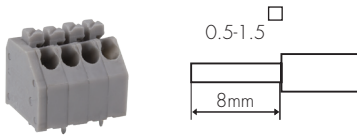

Solid or Stranded wire type 0.5 - 1.5mm²
To make or release the wire from the terminal, use a screwdriver to push down the button.

Wiring Diagram

Without sensor head

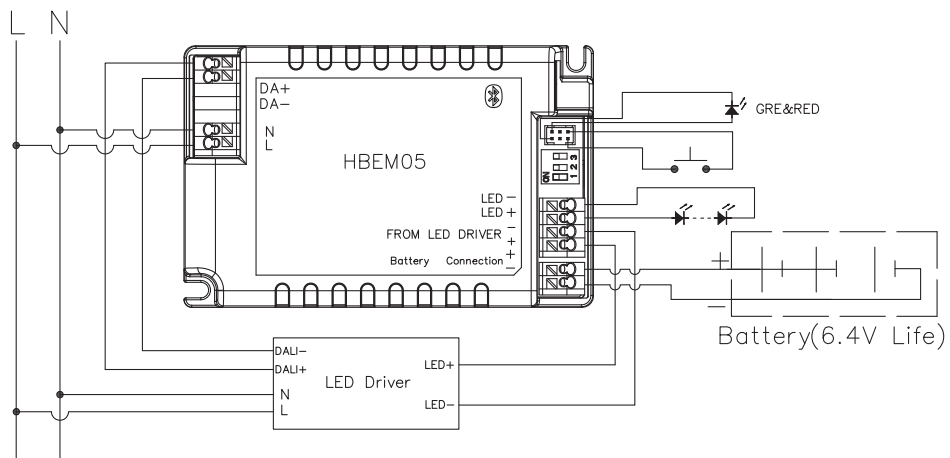

With sensor head

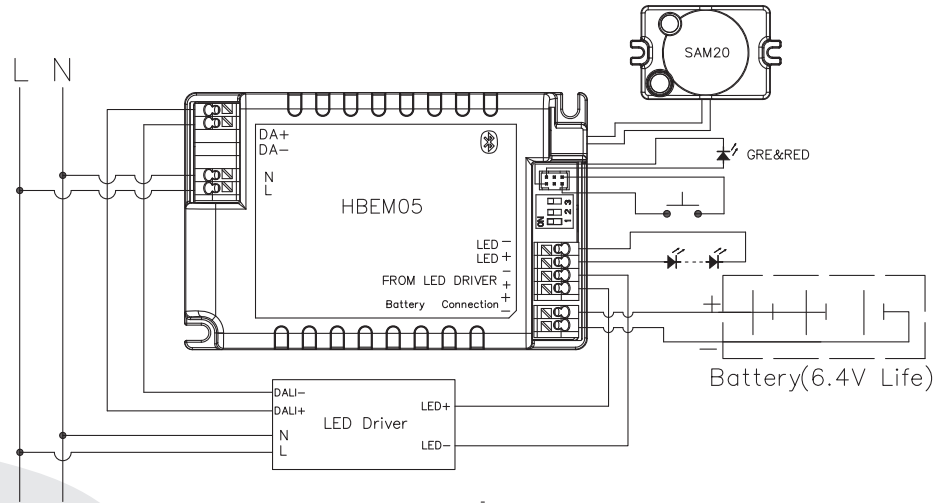

Loading and In-rush Current

Model	HBEM05
In-rush Current (I _{max.})	25A
Pulse Time	80 μs

Circuit Breaker Information

Automatic circuit breaker type	B16A	B10A	B13A	B20A
HBEM05	114	72	92	142

Calculation uses typical values from ABB series S200 as a reference. E.g. Maximum amount = $16 / (P_n / 230)$. We recommend to use no more than 60% of the data as the actual max. number of drivers in real application. Actual values may differ due to used circuit breaker types and installation environment.

Performance Characteristics

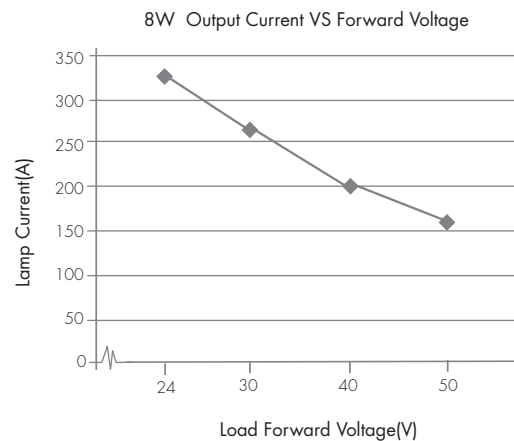
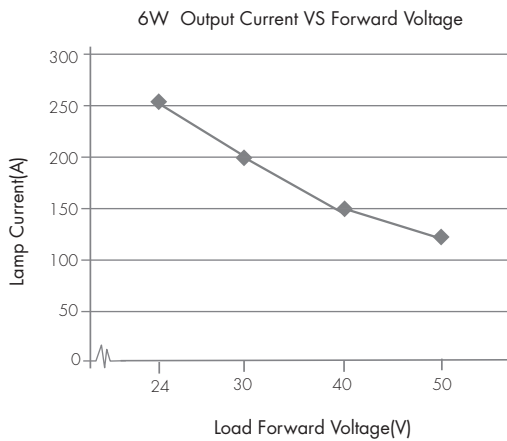

10W Output Current VS Forward Voltage

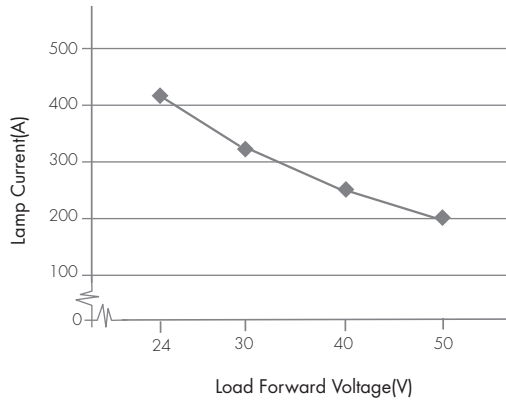

12W Output Current VS Forward Voltage

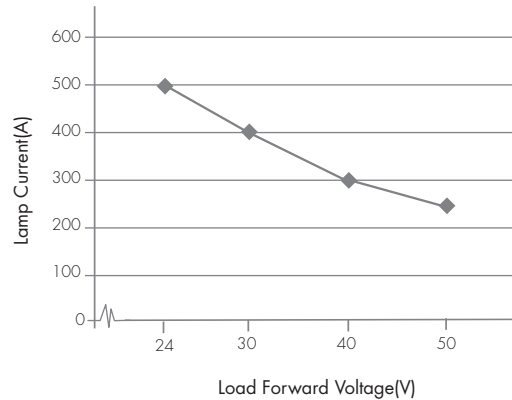

Normal Mode

It is the mode in which mains supply is available, with the battery charged or charging. In this mode, HBEM05 is a dimmable emergency driver, with ability to create scenes and controllable by motion sensor, Push switch and app.

Emergency Mode

It is the mode in which mains supply has failed and whilst the control gear is powered by the battery until deep discharge point. In this mode, HBEM05 is unable to be controlled by motion sensor, Push switch and app. However, some emergency parameters can still be configured via the app, such as time scheduled for self-test, duration for extended emergency mode etc.

Rest Mode

It is the mode in which the luminaire is intentionally off whilst the control gear is powered by the battery. To enter this mode, the prerequisite is that there is no mains supply. In this mode, the luminaire will be turned off automatically and HBEM05 is powered by the battery. If the luminaire is forced to turn on in this mode, HBEM05 will then be adjusted to emergency mode. When mains supply is recovered, HBEM05 will return to normal mode.

Inhibit Mode

It is the mode in which HBEM05 is powered from the mains but prevented from going into emergency mode in the event of mains failure. Please enter this mode only in special applications whereby emergency function is not needed, such as when electrician needs to cut off power supply when doing examination and maintenance work for HBEM05.

Extended Emergency Mode

It is the mode in which the control gear continues to operate the lamp in the same way as in emergency mode for the programmed prolong time after the restoration of the mains supply. When this mode is enabled, HBEM05 will remain in emergency mode even when mains supply is recovered. In this mode, the user has to set the time extended for emergency mode; when the time extended elapses, HBEM05 will then return to normal mode.

Self test (Monthly)

HBEM05 carries out routine test on emergency lighting based on pre-programmed time via the app or after receiving manual commands from the app. During the self test process, tests for load connections (such as open circuit, short-circuit) and battery connections (such as open circuit, short-circuit, polarity reversal etc.) will be carried out.

Self test (Annually)

The test is carried out mainly to check the battery level. The user has to make sure that the battery for HBEM05 is fully charged before HBEM04 carries out annual test. Also, the battery lifetime statistics will be analysed and displayed on a chart basis.

LED Diagnostics

Indicator Colour	Status	Meaning
GREEN SOLID	Device OK	All OK, AC power is present. Battery is connected & charging
GREEN FAST FLASH (0.1s ON, 0.1s OFF)	Monthly test/Functionality test	AC power is present. Monthly test in progress
GREEN SLOW FLASH (1s ON, 1s OFF)	Annual test/Duration test	Annual test are being carried out
GREEN VERY SLOW FLASH (4s ON, 1s OFF)	Prohibited mode	Even AC power is lost, it will not enter emergency mode
RED SOLID	LED fault	LED is open circuit, short circuit or has otherwise failed in some way, Fault can indicate the live status or the result of a test
RED SLOW FLASH (1s ON, 1s OFF)	Battery fault	Battery failure (Battery failed the duration or functional test, battery appears to be defective, battery has incorrect voltage).
RED / GREEN OFF	No power available	AC power is lost, unit in emergency mode

*If you want to see the diagnostic report, please go to the APP or web platform to see the full report and analysis

Note: Before powering on, please plug in the sensor head and then plug in the battery, otherwise the sensor is disabled.

Remedy: Only after the APP is reset and re-connected to the network can the sensor head be re-identified.

Battery Pack Options

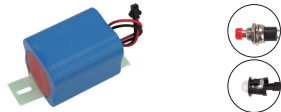
Package code	Picture	Spec.	Size (mm)	Duration	Recharge Time	Accessories
BPC85		LiFePO4, 12.8V/3.4AH		>3h @6W >3h @8W >3h @10W >3h @12W	24h	Battery bracket, LED indicator, Test switch

The storage temperature of the battery should not exceed 50°C, to avoid affecting its service life.

The maximum surface operating temperature of the battery should be strictly limited to 55°C

The relative humidity (RH) for battery storage should be 45% to 85%.

Keep the battery wires unconnected if the battery is intended to be stored for more than 3 months.

The maximum battery cycles under 55°C should not exceed 40 times.

Please kindly charge battery for 24 hours before using.

Do not short-circuit the battery pack.

In case of a short circuit the battery protection opens the connection to the driver and the output is therefore free of voltage. At this time, it will falsely report battery failure. The output will be reactivated again when the short circuit is removed.

Technical Specifications for Sensor Heads

PIR Sensor Properties		
Sensor principle	PIR detection	
Operating voltage	5VDC	
Detection range *	HIRO5 & HIRO5/FM HIRO5/AA & HIRO7	Max installation height: 3m; Max detection range: 6m (diameter)
	HIR 1 1	Max installation height: 15m (forklift); 12m (single person); Max detection range: 24m (diameter)
	HIR 1 2	Max installation height: 15m (forklift); 12m (single person); Max detection range: 18m*6m (L*W)
	HIR63	Max installation height: 3m; Max detection range: 12m (diameter)
	HIR63/R	Max installation height: 12m (forklift); 8m (single person); Max detection range: 14m (diameter)
HF Sensor Properties		
Sensor principle	High Frequency (microwave)	
Operating voltage	5VDC	
Operation frequency	5.8GHz +/- 75MHz	
Transmission power	<0.2mW	
Detection range *	SAM20 & SAM21 SAM22 & SAM22/AA	Max installation height: 3m; Max detection range: 12m (diameter)
	SAM23	Max installation height: 15m (forklift); 12m (single person); Max detection range: 20m (diameter)

* The detection range is heavily influenced by sensor placement (angle) and different walking paces. It may be reduced under certain conditions.

PIR & microwave sensor heads

The range of PIR and microwave sensor heads below offers powerful number of Plug 'n' Play feature options to expand the flexibility of luminaire design. This approach to luminaire design reduces space requirements and component costs whilst simplifying production.

A. HIRO5

PIR sensor head
The cable length is around 65cm.

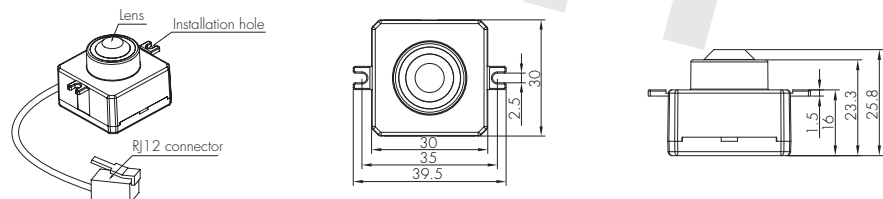

B. HIRO5/FM

PIR sensor head
The cable length is around 65cm.

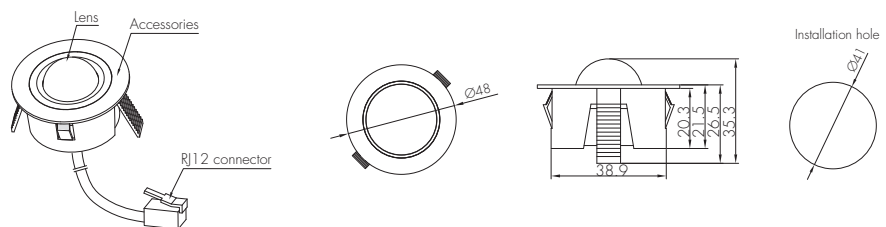

C. HIRO5/AA

PIR sensor head
Adjustable angle
The cable length is around 65cm.

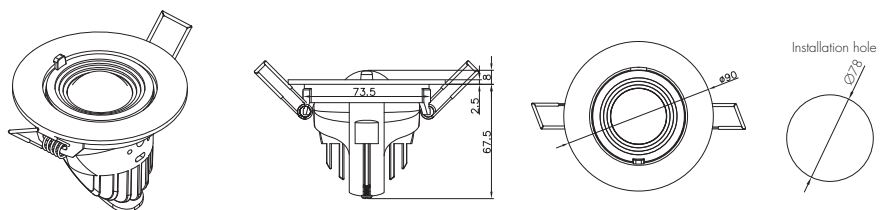

D. HIR07

PIR sensor head
Photocell Advance™
The cable length is around 30cm.

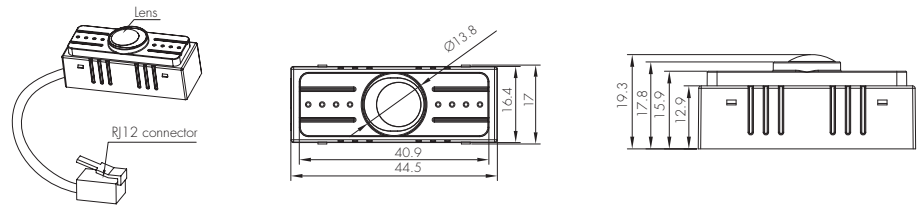

E. HIR11/S

PIR sensor head
Surface mounting
For highbay application
IP65 (facia / lens part)
The cable length is around 65cm.

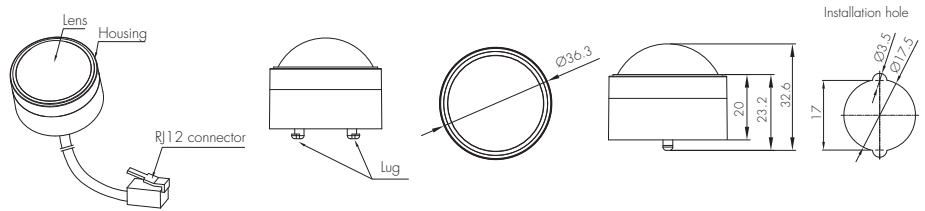

F. HIR11/F

PIR sensor head
Flush mounting
For highbay application
IP65 (facia / lens part)
The cable length is around 65cm.

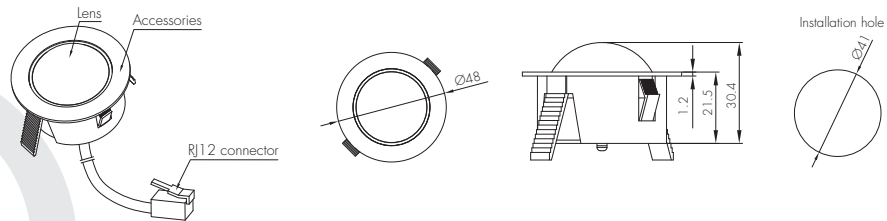

G. HIR11/C

PIR sensor head
Screw to the luminaire by conduit
For highbay application
IP65 (facia / lens part)
The cable length is around 65cm.

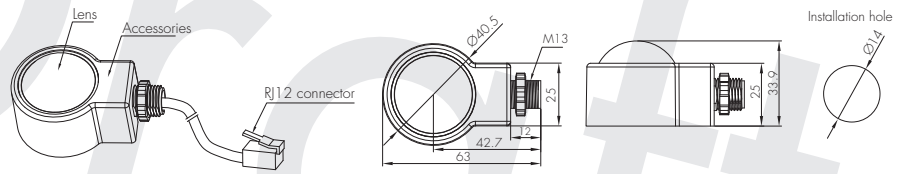

H. HIR12

PIR sensor head
For highbay application
IP65 (facia / lens part)
The cable length is around 65cm.

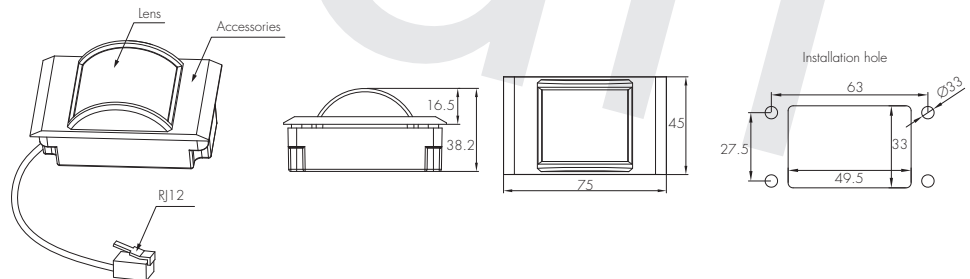

Installation for HIR12



We suggest that the metal plate thickness to be 0.8mm - 1.6mm to ensure perfect focal length for the PIR lens.

I. HIR63

PIR sensor head
The cable length is around 65cm.

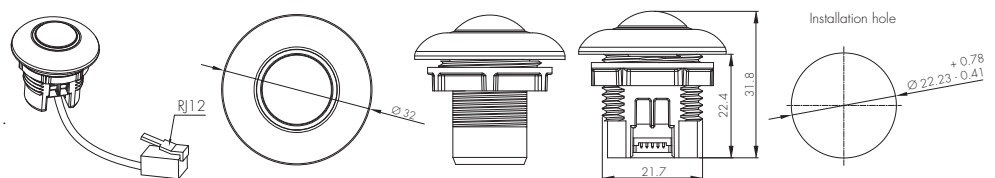

J. HIR63 with HA04
 PIR sensor head
 The cable length is around 65cm.

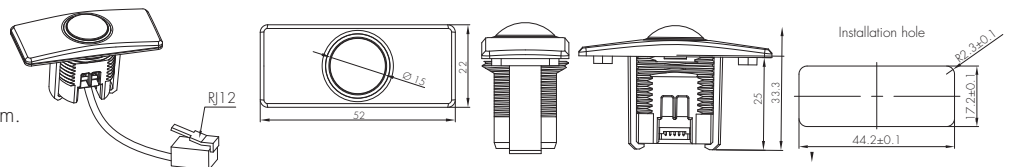

K. HIR63 with HA05
 PIR sensor head
 The cable length is around 65cm.

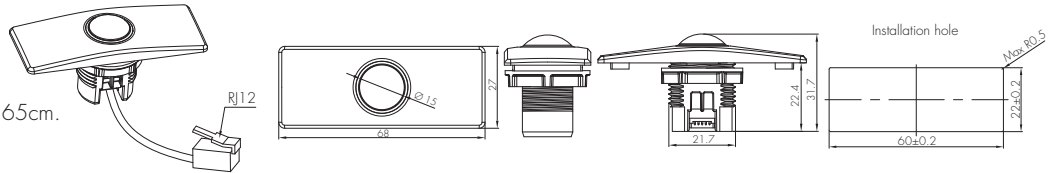

L. HIR63/R
 PIR sensor head
 IP65 (facia / lens part)
 The cable length is around 65cm.

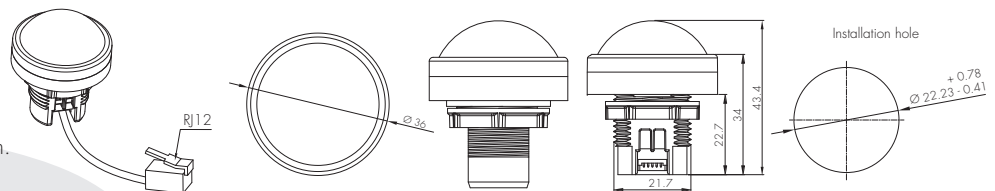

M. SAM20
 HF sensor head
 Photocell Advance™
 The cable length is around 30cm.

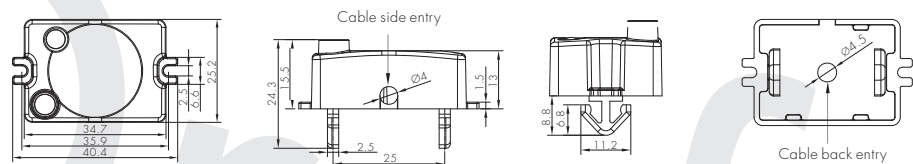

N. SAM21
 HF sensor head
 IP65
 The cable length is around 65cm.

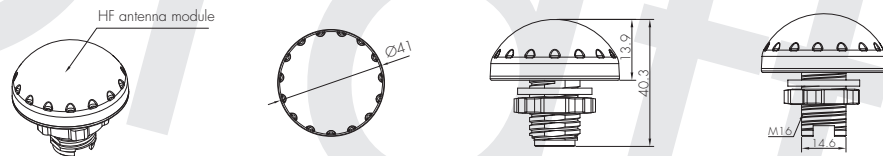

O. SAM22
 HF sensor head
 Flush mount
 The cable length is around 65cm.

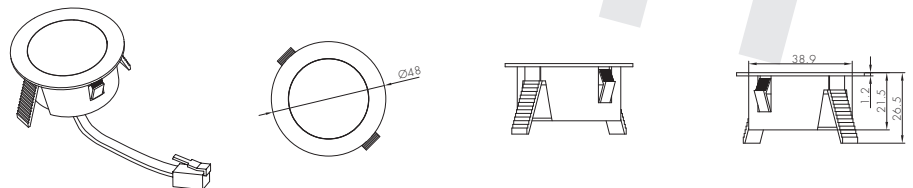

P. SAM22/AA
 HF sensor head
 Adjustable angle
 The cable length is around 65cm.

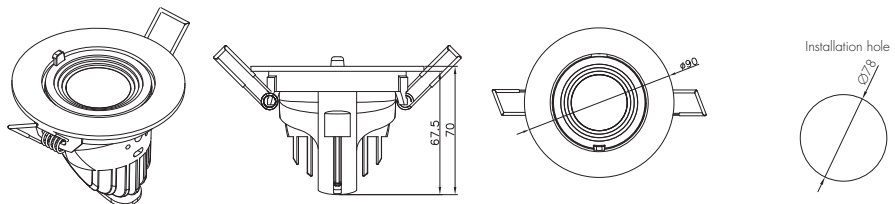

Q. SAM23
 HF sensor head
 Photocell advance™
 Daylight sensor
 For highbay application
 The cable length is around 30cm.

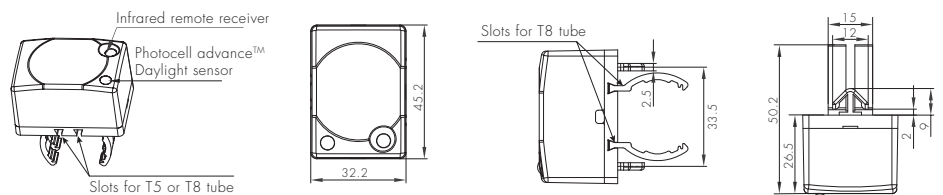

Detection Pattern

SAM23

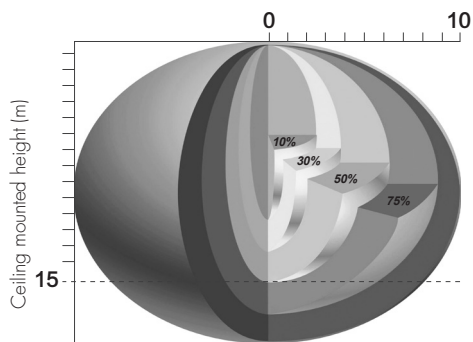

Ceiling mounted detection pattern (m)

SAM20 & SAM21 & SAM22 & SAM22/AA

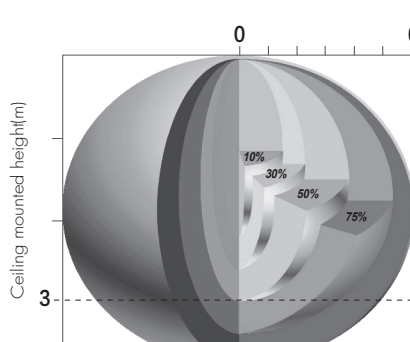

Ceiling mounted detection pattern (m)

HIRO5 & HIRO5/FM & HIRO5/AA & HIRO7

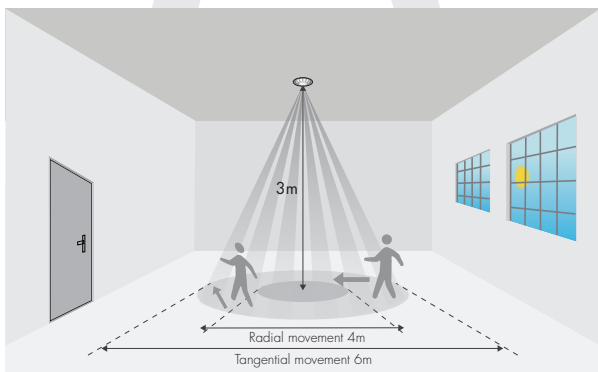

HIR12

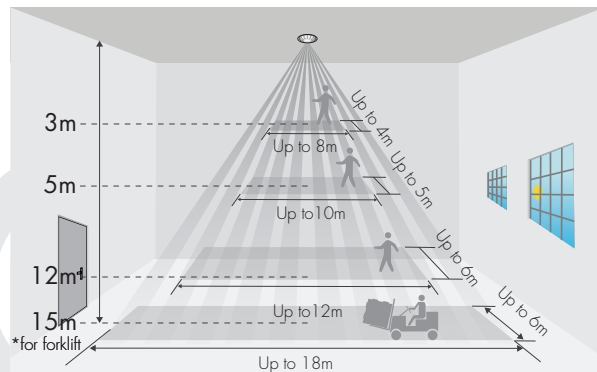

HIR63

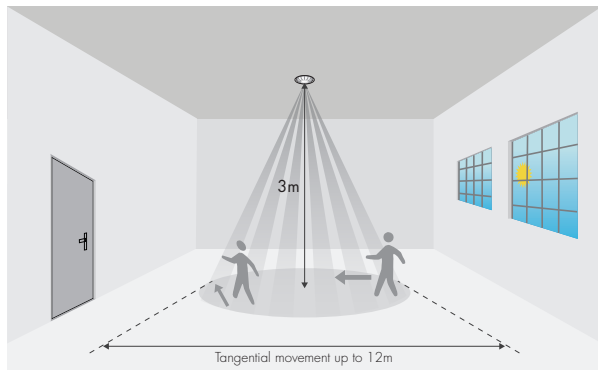

HIR63/R

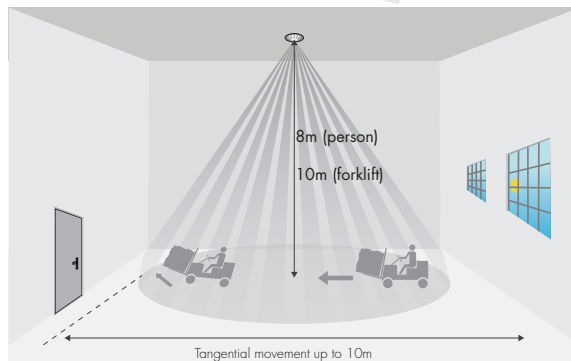

*The detection patterns are based upon 5km/h movement speed.

HIR1 1 Series (High-bay)



HIR1 1 series: High-bay lens detection pattern for forklift @ Ta = 20°C
(Recommended installation height 10m-15m)

A: Tangential movement	B: Radial movement	Mount height	Tangential (A)	Radial (B)
		10m	max 380m ² (Ø = 22m)	max 201m ² (Ø = 16m)
		11m	max 452m ² (Ø = 24m)	max 201m ² (Ø = 16m)
		12m	max 452m ² (Ø = 24m)	max 201m ² (Ø = 16m)
		13m	max 452m ² (Ø = 24m)	max 177m ² (Ø = 15m)
		14m	max 452m ² (Ø = 24m)	max 133m ² (Ø = 13m)
		15m	max 452m ² (Ø = 24m)	max 113m ² (Ø = 12m)



HIR1 1 series: High-bay lens detection pattern for single person @ Ta = 20°C
(Recommended installation height 2.5m-12m)

A: Tangential movement	B: Radial movement	Mount height	Tangential (A)	Radial (B)
		2.5m	max 50m ² (Ø = 8m)	max 7m ² (Ø = 3m)
		6m	max 104m ² (Ø = 11.5m)	max 7m ² (Ø = 3m)
		8m	max 154m ² (Ø = 14m)	max 7m ² (Ø = 3m)
		10m	max 227m ² (Ø = 17m)	max 7m ² (Ø = 3m)
		11m	max 269m ² (Ø = 18.5m)	max 7m ² (Ø = 3m)
		12m	max 314m ² (Ø = 20m)	max 7m ² (Ø = 3m)

Additional Information / Documents

1. Regarding precautions for Bluetooth product installation and operation, please kindly refer to www.hytronik.com/download/knowledge ->Bluetooth Products - Precautions for Product Installation and Operation
2. Regarding precautions and usage for LiFePO4 battery, please kindly refer to www.hytronik.com/download/knowledge ->LiFePO4 Battery - Precautions and Usage
3. Data sheet is subject to change without notice. Please always refer to the most recent release on www.hytronik.com/products/bluetooth-technology ->Bluetooth Emergency Driver/Inverter
4. Regarding Hytronik standard guarantee policy, please refer to www.hytronik.com/download/knowledge ->Hytronik Standard Guarantee Policy