

SensorDIM™ - Integrated HF Sensor and LED Driver

HYTRONIK®

HEC6025/I

Tri-level Control with Photocell Advance™

Applications

Occupancy sensor and constant current LED driver, 2-in-1.





Suitable for building into the fixture for:

- Office / Commercial Lighting
- Classroom
- Meeting Room

Use for retrofit and new luminaire designs/installations



Features

-  Special photocell to measure and differentiate natural light from LED light from behind the fixture cover
-  Tri-level dimming control based upon occupancy (also known as corridor function)
-  DIP switch offers multiple current selections for different luminaire requirements
-  Easy-on-the-eye operation which makes the light turning on/off less uncomfortable
-  5 Year Warranty

Technical Data

Input Characteristics

Model No.	HEC6025/I
Mains voltage	220~240VAC 50/60Hz
Input current	0.14 - 0.12A
Input power	31W (Max.)
Warming-up	20s

Driver Data

Off load voltage	51V
Power factor	≥0.9
Efficiency	84% (Max.)
Output current	220/400/400/570mA

Safety and EMC

EMC standard (EMC)	EN55015, EN61547 EN6100-3-2, EN61000-3-3
Safety standard (LVD)	EN61347-1, EN61347-2-13
Dielectric strength	Input→output: 3000VAC / 5mA / 1min
Abnormal protection	Output short-circuit protection
Certification	CE, EMC, RED, RCM

Sensor Data

Model No.	HEC6025/I
Sensor principle	High Frequency (microwave)
Operation frequency	5.8GHz +/- 75MHz
Transmission power	<0.2mW
Detection range	Max. (∅ x H) 12m x 6m
Detection angle	30° ~ 150°
Setting adjustments:	
Sensitivity	100% / 50%
Hold time	5s / 90s / 3min / 10min
Daylight threshold	Disable / 50lux / 10lux / 2lux
Stand-by period	0s / 10s / 10min / +∞
Stand-by dimming level	10% / 30%

Environment

Operation temperature	Ta: -20°C ~ +60°C
Case temperature (Max.)	Tc: +80°C
IP rating	IP20

CE emc RED  CB IP20

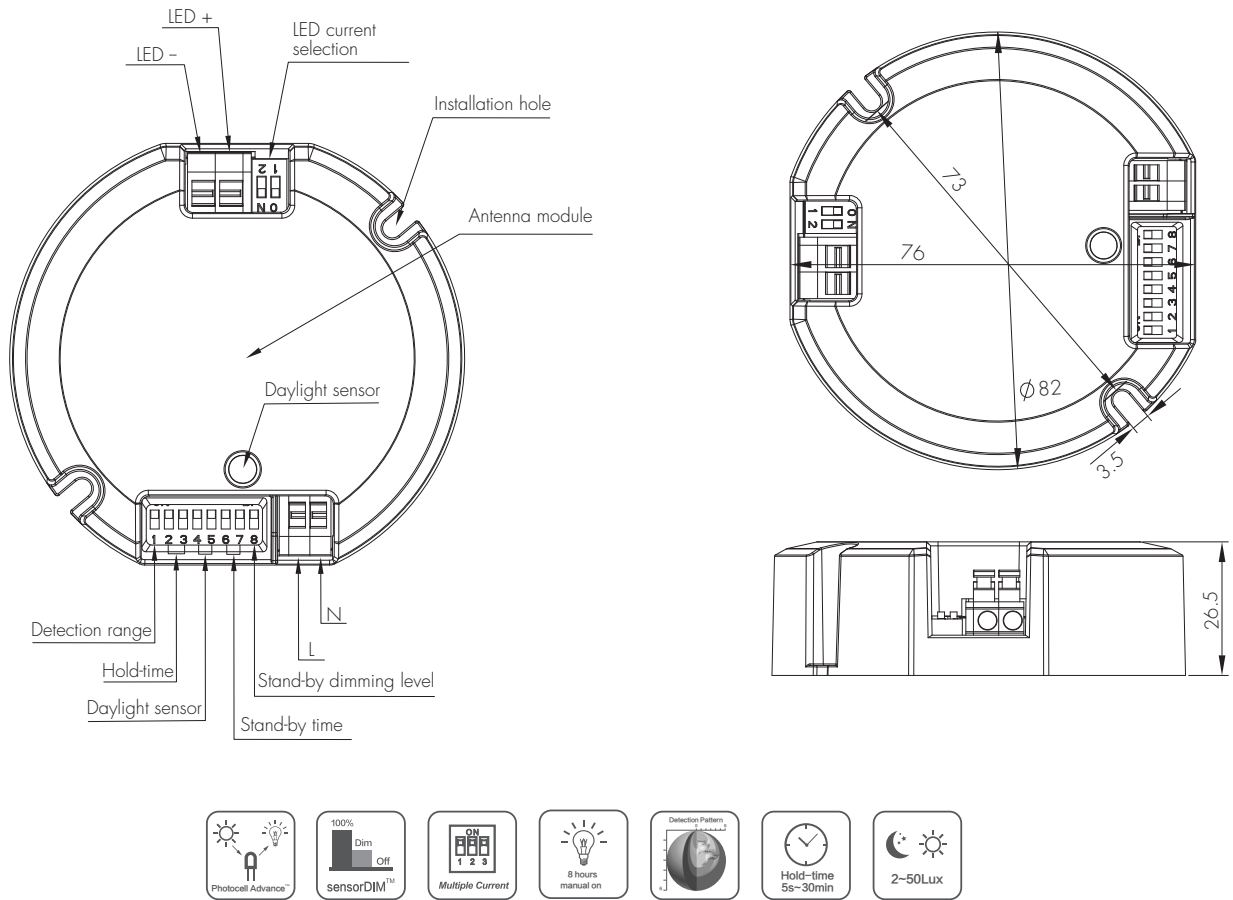

2 in 1 and cost effective! This is a smart integration of microwave motion sensor and multiple current selection LED driver, which gives pre-selected constant current to drive the LEDs to work based upon movement detection.

Functions and Features

1 Photocell Advance™ Function

It's well known that LED lights have a totally different spectrum to natural light. Hytronik uses this principle and comes up with special photocell and sophisticated software algorithm to measure and differentiate natural light from LED light from behind the fixture cover, so that this photocell can ignore internal LED light and only respond to the natural light outside. Our technology has no infringement to the existing patents in the market.

Settings on this demonstration:

Hold-time: 10min

Daylight threshold: 50lux

Stand-by dimming level: 10%

Stand-by period: +∞

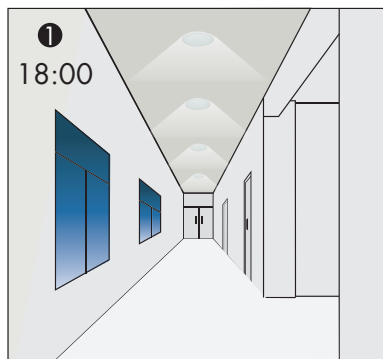

The light automatically turns on at dim level when natural light lux level drops below pre-set daylight threshold.

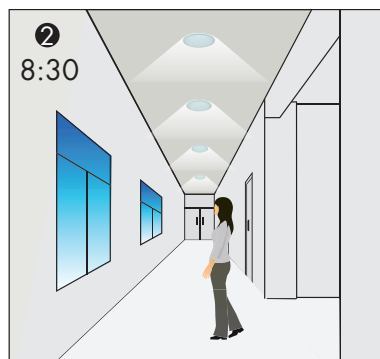

With insufficient natural light, the light switches on at 100% when there is motion detected.

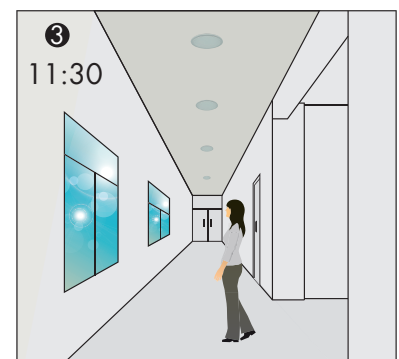

The light turns off completely whenever natural light reaches above pre-set daylight threshold, even with presence.

2 Tri-level Control (Corridor Function)

Hytronik builds this function inside the motion sensor to achieve tri-level control, for some areas which require a light change notice before switch-off. The sensor offers 3 levels of light: 100%→dimmed light→off; and 2 periods of selectable waiting time: motion hold-time and stand-by period; Selectable daylight threshold and freedom of detection area.

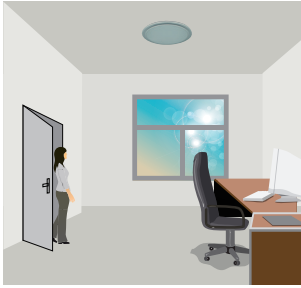

With sufficient natural light, the light does not switch on when presence is detected.

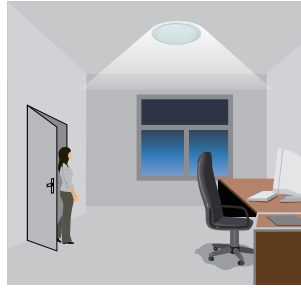

With insufficient natural light, the sensor switches on the light automatically when presence is detected.

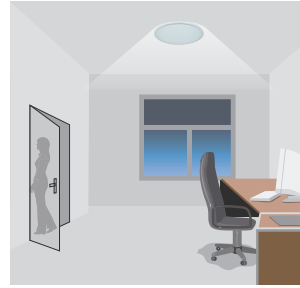

After hold-time, the light dims to stand-by level preset.



Light switches off automatically after the stand-by period elapses.

3 8H Manual on Mode for LED Lamp

Rapidly turn off/on the power supply three times within 3 seconds, the light will be 100% on for 8 hours, and then goes to sensor mode automatically after 8 hours. Useful when sensor function is not needed in special occasion.

Note: this 8H manual on mode can be cancelled by turning off/on the power supply one time within 1 second.

Detection Pattern

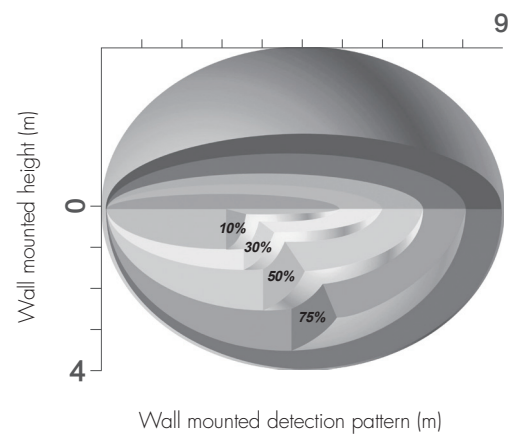
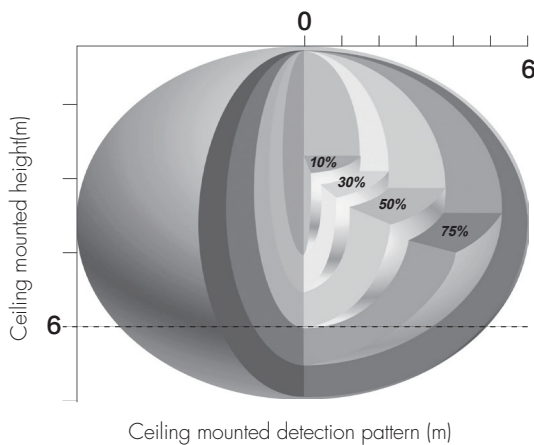

DIP Switch Settings

1 Detection Range

Sensor sensitivity can be adjusted by selecting the combination on the DIP switches to fit precisely for each specific application.

	1			
I	●	100%		I – 100%
II	○	50%		II – 50%

2 Hold Time

Select the DIP switch configuration for the light on-time after presence detection. This function is disabled when natural light is sufficient.

	2	3			
I	●	●	5s		I – 5s
II	●	○	90s	II – 90s	
III	○	●	1min	III – 3min	
IV	○	○	3min	IV – 10min	

3 Daylight Threshold

Set the level according to the fixture and environment. The light will not turn on if ambient lux level exceeds the daylight threshold preset.

Please note that the ambient lux level refers to internal light reaching the sensor.

Disabling the daylight sensor will put the sensor into occupancy detection only mode.

	4	5	
I	●	●	Disable
II	●	○	50Lux
III	○	●	10Lux
IV	○	○	2Lux



- I – Disable
- II – 50Lux
- III – 10Lux
- IV – 2Lux

4 Stand-by period (corridor function)

This is the time period you would like to keep at the low light output level before it is completely switched off in the long absence of people.

Note: "0s" means on/off control; "+∞" means the stand-by period is infinite and the light is effectively controlled by the daylight sensor, off when natural light is sufficient and automatically on at dimming level when insufficient.

	6	7	
I	●	●	0s
II	●	○	5min
III	○	●	90min
IV	○	○	+∞



- I – 0s
- II – 10s
- III – 10min
- IV – +∞

5 Stand-by dimming level

The setting is used to select the desired dimmed light level used in periods of absence for enhanced comfort and safety.

	8	
I	●	10%
II	○	30%



- I – 10%
- II – 30%

LED Driver Specification

1 LED Current Selections



I	●	●	570mA
II	○	●	400mA
III	●	○	400mA
IV	○	○	220mA
	1	2	Current



The current can be easily configured by choosing the correct combination of the DIP switches (see table on the left).

2 LED Maximum Load and Voltage

This multiple current LED driver has a wide range of loading capacity:

Maximum load @ different currents:	3.5~10W (220mA)	6~18W (400mA)
	6~18W (400mA)	8.5~24W (570mA)

Maximum voltage @ different currents:	15~45V (220mA)	15~45V (400mA)
	15~45V (400mA)	15~42V (570mA)