

## DALI-to Bluetooth Converter/Translator Module

HBIREM29

Low-bay

HBIREM29/W

Wide range Low-bay

HBIREM29/R

Reinforced Low-bay

HBIREM29/H

High-bay

# HYTRONIK®



### Product Description

HBIREM29 is a DALI/Bluetooth converter but integrated with a PIR sensor inside, which converts a standard DALI/DALI2 emergency driver output to Bluetooth output, it enables users to manage and customize monthly functional and annual duration tests based on the Koolmesh Emergency system. It can be used as normal Bluetooth stand-alone PIR sensor either. The high-end Koolmesh platform provides powerful and convenient features, for users, they can effortlessly view, edit, and oversee the entire emergency system; for features, scheduling a monthly self-test or annual self-test in the app, checking the DALI/DALI2 emergency drivers' status, including automatic email notification upon detecting the fault, automatic monthly/annually (functional/duration test) emergency report generation, etc. All the settings and parameters can be set in Koolmesh app, all the information such as reports can be viewed and downloaded from Koolmesh IoT platform.

In addition, HBIREM29 can control several DALI/DALI2 DT6 or DT8 drivers at the same time.



HBIREM29



HBIREM29/R



HBIREM29/W



HBIREM29/H

### App Features

Quick setup mode & advanced setup mode

Web app/platform for project deployment & data analysis

Koolmesh Pro app on iPad for on-site configuration

Floorplan feature to simplify project planning

coming soon

One-key device replacement

Device social relations check

Staircase function (primary & secondary)

Remote control via gateway support HBGW01

Heat map

Dynamic daylight harvest auto-adaptation

Grouping luminaires via mesh network

Scenes

Dusk/Dawn photocell (Twilight function)

Tri-level control

Daylight harvest

Circadian rhythm (Human centric lighting)

Push switch configuration

Detailed motion sensor settings

Schedule

Astro timer (sunrise and sunset)

Power-on status (memory against power loss)

Offline commissioning

Bulk commissioning (copy and paste settings)

Different permission levels via authority management

Network sharing via QR code or keycode

Interoperability with Hytronik Bluetooth product portfolio

Compatible with EnOcean BLE switches

Internet-of-Things (IoT) featured

Device firmware update over-the-air (OTA)

Continuous development in progress...

### Hardware Features

80mA DALI broadcast output

Support to control DT8 LED drivers

2 Push inputs for flexible manual control

IP20/IP54 Ceiling/Surface mount box available as accessory

Two types of blind inserts / blanking plates

User-friendly design for installation

High bay version available (up to 1.5m in height)

5-year warranty

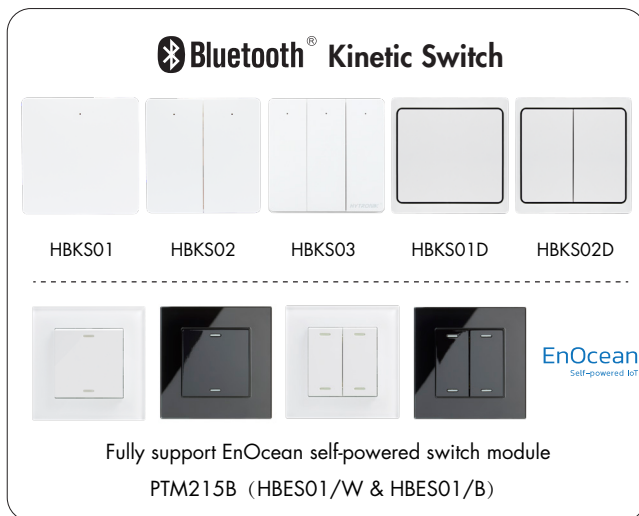

### Note:

1. 1 pc HBIREM29 convertor for 1 pc 3rd party DALI/DALI2 emergency driver.
2. 1 pc HBIREM29 convertor can control several DALI/DALI2 DT6 or DT8 drivers at the same time.
3. With Bluetooth gateway HBGW01, users can remotely control and monitor emergency system via Koolmesh mobile/tablet app & web app platform.
4. HBIREM29 & 3rd Party standard DALI/DALI2 emergency driver does not need to connect to central DALI PSU.
5. HBIREM29 provides power supply to the 3rd party standard DALI/DALI2 emergency driver and DT6 or DT8 drivers.

### Technical Specifications

Bluetooth Transceiver	
Operation frequency	2.4 GHz - 2.483 GHz
Transmission power	4 dBm
Range (Typical indoor)	10~30m
Protocol	Bluetooth® 5.0 SIG Mesh

Input & Output Characteristics	
Operating voltage	220~240VAC 50/60Hz
Stand-by power	< 1W
Switched power	Max. 40 devices, 80mA
Warming-up	20s

Sensor Data	
Sensor Model	PIR detection
HBIREM29	Installation Height : 6m Detection Range(Ø) : 9m
HBIREM29/R	Installation Height : 6m Detection Range(Ø) : 10m
HBIREM29/W	Installation Height : 6m Detection Range(Ø) : 18m
HBIREM29/H	Installation height: 1.5m (forklift) 1.2m (person) Detection range (Ø): 24m
Detection angle	360°

Safety & EMC	
EMC standard (EMC)	EN55015, EN61000, EN61547
Safety standard (LVD)	EN60669-1, EN60669-2-1 AS/NZS60669-1/-2-1
RED	EN300328, EN301489-1/-1.7
Certification	CB, CE, EMC, RED, RCM

Environment	
Operation temperature	Ta: -20°C ~ +50°C
IP rating	IP20
IP rating (facial part)	IP54

\* For more details of detection range, please refer to "detection pattern" section.

\* IP54 (facial part) only for lens of standard, /R, /H

## Mechanical Structure & Dimensions

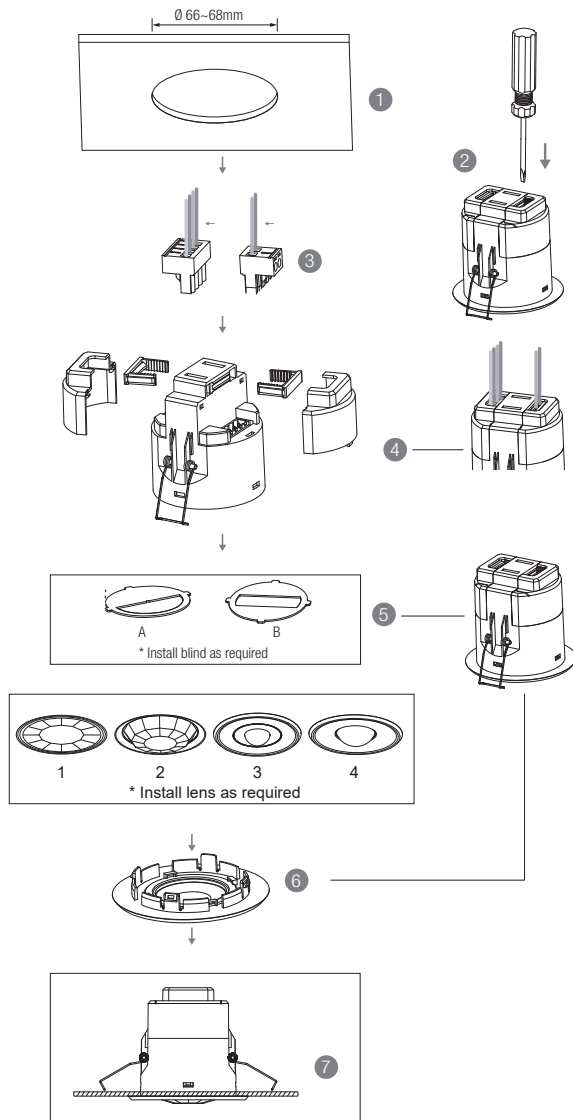

1. Ceiling (drill hole  $\varnothing$  66~68mm)
2. Carefully prise off the cable clamps.
3. Make connections to the pluggable terminal blocks.
4. Insert plug connectors and secure using the provided cable clamps, then clip terminal covers to the base.
5. Fit detection blind (if required) and desired lens.
6. Clip fascia to body.
7. Bend back springs and insert into ceiling.

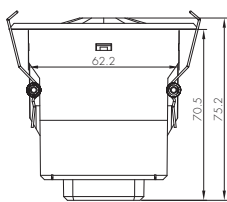
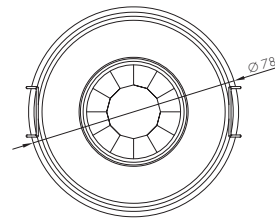

HBIREM29

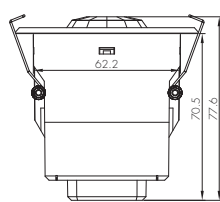

HBIREM29/R

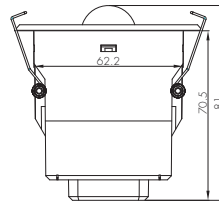

HBIREM29/W

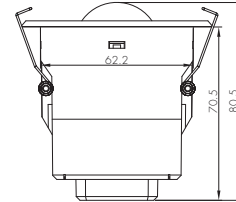

HBIREM29/H

## Wire Preparation

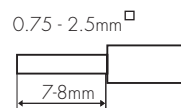

Pluggable screw terminal. It is recommended to make connections to the terminal before fitting to the sensor.

1. 200 metres (total) max. for 1mm<sup>2</sup> CSA (Ta = 50°C)
2. 300 metres (total) max. for 1.5mm<sup>2</sup> CSA (Ta = 50°C)

## Wiring Diagram

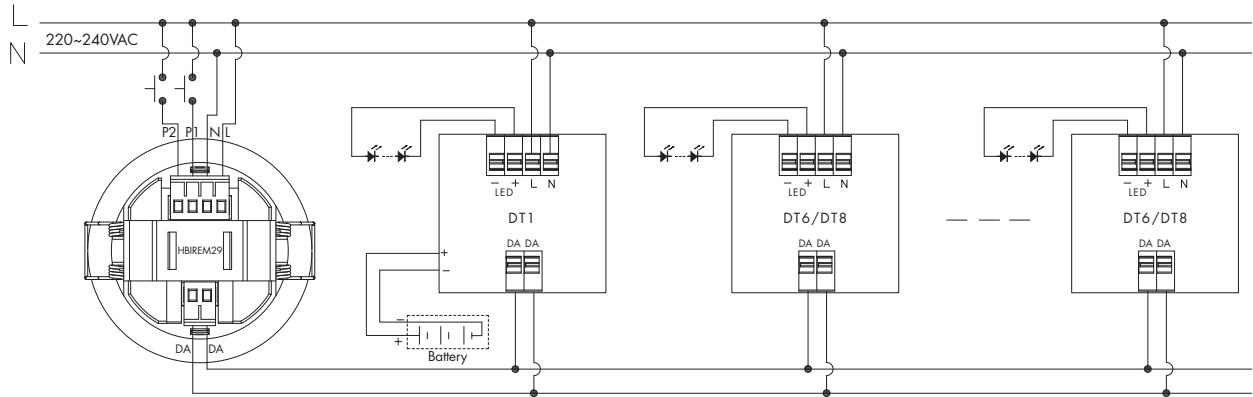

—This product should be installed by a qualified electrician.

## Placement Guide and Typical Range

### Smart Phone to Device Range

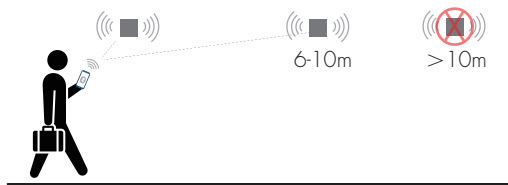

The smart device with the App installed will have a typical range of 10m, but varies from device to device. During commissioning, the installer will need to be in range of the devices when searching for devices to add to the network.

Once the devices have been added to the network via the App, the devices will start communicating within the wireless mesh. This means that once the network is complete, all devices are accessible from the smart device when in a 20m range of a single point.

Big and small silicon gasket used to make IP54 degree protection (mounted into HA09 housing for ceiling mount)

### Small silicon water-proof gasket dimension(size:mm)

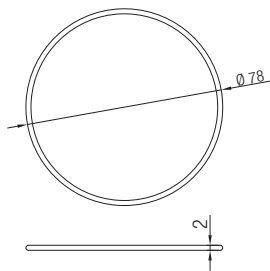

### Big silicon water-proof gasket dimension(size:mm)

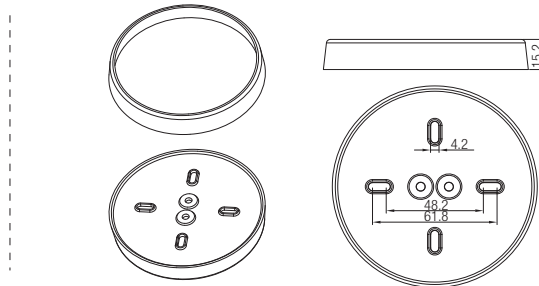

Note: The small silicon water-proof gasket is not suitable for HBIREM29/W and HBIREM29/UH  
The Big silicon water-proof gasket is not suitable for HBIREM29/W

# 1. HBIREM29 (Low-bay)



**HBIREM29:** Low-bay flat lens detection pattern for **single person** @ Ta = 20°C

(Recommended ceiling mount installation height **2.5m-6m**)

A: Tangential movement	B: Radial movement	Mount height	Tangential (A)	Radial (B)
		2.5m	max 50m <sup>2</sup> (Ø = 8m)	max 13m <sup>2</sup> (Ø = 4m)
		3m	max 64m <sup>2</sup> (Ø = 9m)	max 13m <sup>2</sup> (Ø = 4m)
		4m	max 38m <sup>2</sup> (Ø = 7m)	max 13m <sup>2</sup> (Ø = 4m)
		5m	max 38m <sup>2</sup> (Ø = 7m)	max 13m <sup>2</sup> (Ø = 4m)
		6m	max 38m <sup>2</sup> (Ø = 7m)	max 13m <sup>2</sup> (Ø = 4m)

Optional Accessory -- Ceiling/Surface Metal Mount Box: HA09/W, HA09/B, HA09/G

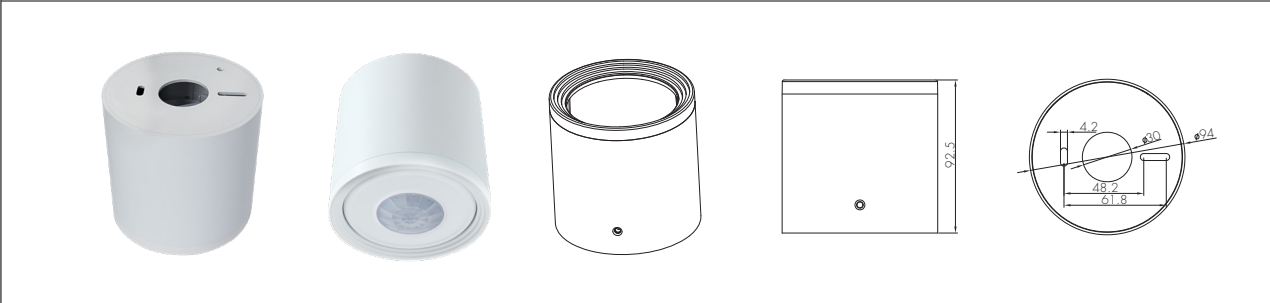

Optional Accessory -- Blind Insert for Blocking Certain Detection Angles

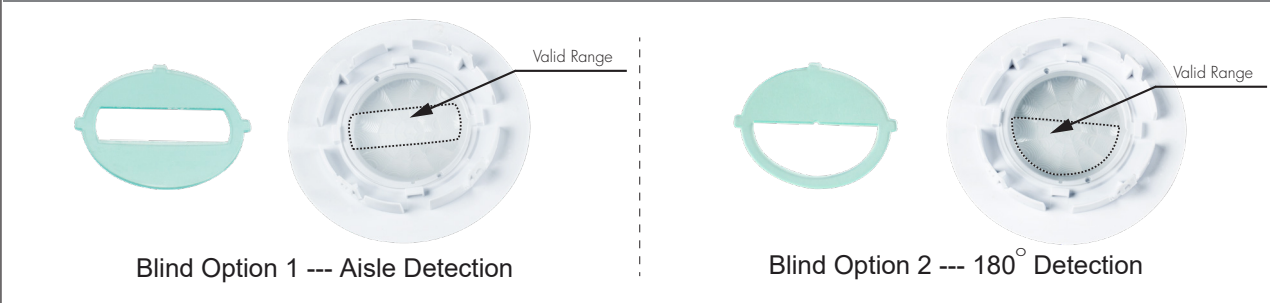

## 2. HBIREM29/R (Reinforced Low-bay)



**HBIREM29/R:** Low-bay convex lens detection pattern for **single person** @  $T_a = 20^\circ\text{C}$

(Recommended ceiling mount installation height **2.5m-6m**)

A: Tangential movement	B: Radial movement	Mount height	Tangential (A)	Radial (B)
		2.5m	max 79m <sup>2</sup> (∅ = 10m)	max 20m <sup>2</sup> (∅ = 5m)
		3m	max 79m <sup>2</sup> (∅ = 10m)	max 20m <sup>2</sup> (∅ = 5m)
		4m	max 64m <sup>2</sup> (∅ = 9m)	max 20m <sup>2</sup> (∅ = 5m)
		5m	max 50m <sup>2</sup> (∅ = 8m)	max 20m <sup>2</sup> (∅ = 5m)
		6m	max 50m <sup>2</sup> (∅ = 8m)	max 20m <sup>2</sup> (∅ = 5m)

Optional Accessory --- Ceiling/Surface Metal Mount Box: HA09/W, HA09/B, HA09/G

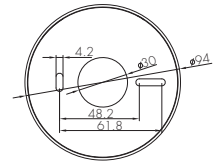
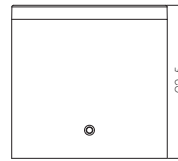
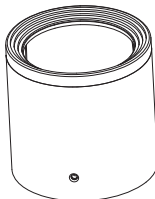

Optional Accessory --- Blind Insert for Blocking Certain Detection Angles

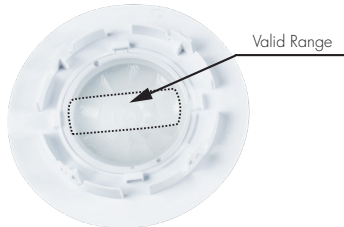

Blind Option 1 --- Aisle Detection

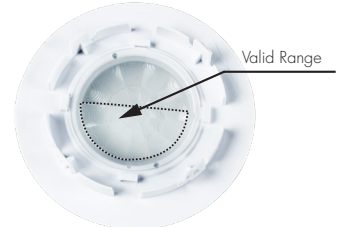

Blind Option 2 --- 180° Detection

## 3. HBIREM29/W (Wide range Low-bay)



**HBIREM29/W:** Low-bay convex lens detection pattern for **single person** @  $T_a = 20^\circ\text{C}$

(Recommended ceiling mount installation height **2.5m-6m**)

A: Tangential movement	B: Radial movement	Mount height	Tangential (A)	Radial (B)
		2.5m	max 254m <sup>2</sup> (∅ = 18m)	max 28m <sup>2</sup> (∅ = 6m)
		3m	max 254m <sup>2</sup> (∅ = 18m)	max 28m <sup>2</sup> (∅ = 6m)
		4m	max 154m <sup>2</sup> (∅ = 14m)	max 28m <sup>2</sup> (∅ = 6m)
		5m	max 113m <sup>2</sup> (∅ = 12m)	max 28m <sup>2</sup> (∅ = 6m)
		6m	max 79m <sup>2</sup> (∅ = 10m)	max 13m <sup>2</sup> (∅ = 4m)

Optional Accessory --- Ceiling/Surface Metal Mount Box: HA09/W, HA09/B, HA09/G

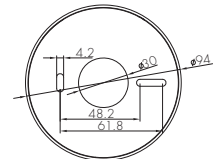
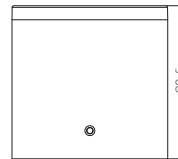
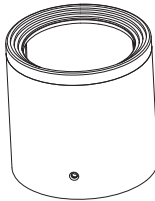

### 3. HBIREM29/H (High-bay)



**HBIREM29/H:** High-bay lens detection pattern for **forklift** @  $T_a = 20^\circ\text{C}$

(Recommended ceiling mount installation height **10m-15m**)

A: Tangential movement	B: Radial movement	Mount height	Tangential (A)	Radial (B)
		10m	max 380m <sup>2</sup> (Ø = 22m)	max 201m <sup>2</sup> (Ø = 16m)
		11m	max 452m <sup>2</sup> (Ø = 24m)	max 201m <sup>2</sup> (Ø = 16m)
		12m	max 452m <sup>2</sup> (Ø = 24m)	max 201m <sup>2</sup> (Ø = 16m)
		13m	max 452m <sup>2</sup> (Ø = 24m)	max 177m <sup>2</sup> (Ø = 15m)
		14m	max 452m <sup>2</sup> (Ø = 24m)	max 133m <sup>2</sup> (Ø = 13m)
		15m	max 452m <sup>2</sup> (Ø = 24m)	max 113m <sup>2</sup> (Ø = 12m)



**HBIREM29/H:** High-bay lens detection pattern for **single person** @  $T_a = 20^\circ\text{C}$

(Recommended ceiling mount installation height **2.5m-12m**)

A: Tangential movement	B: Radial movement	Mount height	Tangential (A)	Radial (B)
		2.5m	max 50m <sup>2</sup> (Ø = 8m)	max 7m <sup>2</sup> (Ø = 3m)
		6m	max 104m <sup>2</sup> (Ø = 11.5m)	max 7m <sup>2</sup> (Ø = 3m)
		8m	max 154m <sup>2</sup> (Ø = 14m)	max 7m <sup>2</sup> (Ø = 3m)
		10m	max 227m <sup>2</sup> (Ø = 17m)	max 7m <sup>2</sup> (Ø = 3m)
		11m	max 269m <sup>2</sup> (Ø = 18.5m)	max 7m <sup>2</sup> (Ø = 3m)
		12m	max 314m <sup>2</sup> (Ø = 20m)	max 7m <sup>2</sup> (Ø = 3m)

Optional Accessory --- Ceiling/Surface Metal Mount Box: HA09/W, HA09/B, HA09/G

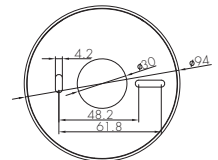
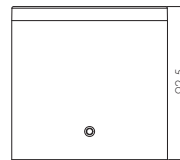

Optional Accessory --- Blind Insert for Blocking Certain Detection Angles

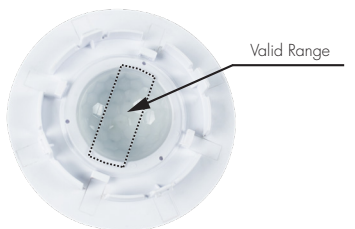

Blind Option 1 --- Aisle Detection

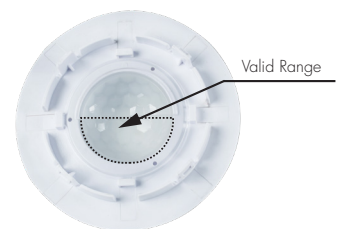

Blind Option 2 --- 180° Detection

## Normal Mode

It is the mode in which mains supply is available, with the battery charged or charging. In this mode, HBIREM29 is a Bluetooth stand-alone PIR sensor with ability to create scenes and controllable by Push switch, schedules and app.

## Emergency Mode

It is the mode in which mains supply has failed and whilst the control gear is powered by the battery until deep discharge point. In this mode, HBIREM29 is unable to be controlled by other motion sensor, Push switch, schedules and app. However, some emergency parameters can still be conjured via the app, such as time scheduled for self-test, duration for extended emergency mode etc.

## Rest Mode

It's the mode in which the luminaires are intentionally off whilst the control gear is powered by the battery. To enter this mode, the prerequisite is that there is no mains supply. In this mode, the luminaires will be turned off automatically and HBIREM29 is powered by the battery. If the luminaires are forced to turn on in this mode, HBIREM29 will then be adjusted to emergency mode. When mains supply is recovered, HBIREM29 will return to normal mode.

## Inhibit Mode

It is the mode in which HBIREM29 is powered from mains but prevented from going into emergency mode in the event mains failure. Please enter this mode only in special applications whereby emergency functions is not needed, such as when electricians need to cut off power supply when doing examinations and maintenance work of HBIREM29.

## Extended Emergency Mode

It is the mode in which the control gear continues to operate the luminaires in the same way as in emergency mode for the programmed prolong time after the restorations of the mains supply. When this mode is enabled, HBIREM29 will remain in emergency mode even when mains supply is recovered. In this mode, the user must set the time extended for emergency mode; when the time extended elapses, HBIREM29 will return to normal mode.

## Self test (Monthly)

HBIREM29 carries out routine test on emergency lighting based on pre-programmed time via the app & web app platform or after receiving manual commands from the app & web app platform. During the self test process, tests for load connections (such as open circuit, short-circuit) and battery connections (such as open circuit, short-circuit, polarity reversal etc.) will be carried out.

All the DALI emergency drivers Self Test feedbacks, results and related Events (Such as the open circuit and short circuit of the load connection, open circuit and short circuit for battery connection) are generated by the driver itself, the HBIREM29 convertor series will only retrieve the data from the emergency driver and translate the DALI feedback into Bluetooth Mesh data correctly and accurately and display to the end user interface (App and Web app Platform). It will not contain any Emergency Self Test circuit in the products itself.

## Self test (Annually)

The test is carried out mainly to check the battery level. The user must make sure that the battery for DALI emergency driver is fully charged before HBIREM29 carries out annual test. Also, the battery lifetime statistics will be analysed and displayed on a chart basis.

## Push switch function

Users can connect Push switch to HBIREM29 to achieve multiple functions such as manually trigger monthly self test, annually self test, invalid and back to normal mode. Those options can be selected in Koolmesh app Push switch settings.



## Dimming Interface Operation Notes

### Switch-Dim

The provided Switch-Dim interface allows for a simple dimming method using commercially available non-latching (momentary) wall switches. Detailed Push switch configurations can be set on Koolmesh app.

Switch Function	Action	Descriptions
Push switch	Short press (<1 second) * Short press has to be longer than 0.1s, or it will be invalid.	- Turn on/off - Turn on only - Turn off only - Recall a scene - Quit manual mode - Do nothing
	Double push	- Turn on only - Turn off only - Recall a scene - Quit manual mode - Do nothing
	Long press (≥1 second)	- Dimming - Colour tuning - Do nothing
Sensor-link	/	- Upgrade a normal on/off motion sensor to a Bluetooth controlled motion sensor
Emergency Self-Test Function	Short press (<1 second) * Short press has to be longer than 0.1s, or it will be invalid.	- Start Self test (Monthly) - Stop Self test - Start Self test (Annually) - Invalid
	Long press (≥1 second)	- Start Self test (Monthly) - Stop Self test - Start Self test (Annually) - Invalid
Fire Alarm (VFC signal only)	Refer to <b>Koolmesh</b> ® App User Manual V2.1	- Able to connect the Fire Alarm system - Once the fire alarm system is triggered, all the luminaries controlled by the Push Switch will enter the preset scene (normally it's full on), after the fire alarm system gives the ending signal, all the luminaries controlled by this Push Switch will revert back to normal status.

## Additional Information / Documents

- To learn more about detailed product features/functions, please refer to [www.hytronik.com/download ->knowledge ->Introduction of App Scenes and Product Functions](http://www.hytronik.com/download->knowledge->Introduction%20of%20App%20Scenes%20and%20Product%20Functions)
- Regarding precautions for Bluetooth product installation and operation, please kindly refer to [www.hytronik.com/download ->knowledge ->Bluetooth Products - Precautions for Product Installation and Operation](http://www.hytronik.com/download->knowledge->Bluetooth%20Products%20-%20Precautions%20for%20Product%20Installation%20and%20Operation)
- Regarding precautions for PIR Sensors installation and operation, please kindly refer to [www.hytronik.com/download ->knowledge ->PIR Sensors - Precautions for Product Installation and Operation](http://www.hytronik.com/download->knowledge->PIR%20Sensors%20-%20Precautions%20for%20Product%20Installation%20and%20Operation)
- Data sheet is subject to change without notice. Please always refer to the most recent release on [www.hytronik.com/products/bluetooth technology ->Bluetooth Sensors](http://www.hytronik.com/products/bluetooth%20technology->Bluetooth%20Sensors)
- Regarding Hytronik standard guarantee policy, please refer to [www.hytronik.com/download ->knowledge ->Hytronik Standard Guarantee Policy](http://www.hytronik.com/download->knowledge->Hytronik%20Standard%20Guarantee%20Policy)