

DALI-2 HF Sensor

HYTRONIK®

HCD418

Tri-level Control for Independent DALI-2



Applications

Occupancy detector with tri-level control suitable for indoor use.

Suitable for building into the fixture:

- Office / Commercial Lighting
- Classroom
- Meeting Room

Use for retrofit and new luminaire designs/installations



Features

- Tri-level dimming control based upon occupancy (also known as corridor function)
- DALI-2 dimming control method (DALI power supply circuit included)
- 5-Year Warranty

Technical Data

Input Characteristics

Model No.	HCD418
Mains voltage	220~240V~ 50/60Hz
Stand-by power	<0.5W
Output	I guaranteed: 32mA I max: 40 mA U rated: 15VDC
Warming-up	20s

Safety and EMC

EMC standard (EMC)	EN55015, EN61000
Safety standard (LVD)	EN60669, AS/NZS60669
Radio Equipment (RED)	EN300440, EN301489, EN62479
Certification	Semko, CB, CE, EMC, RED, RCM

Sensor Data

Model No.	HCD418
Sensor principle	High Frequency (microwave)
Operation frequency	5.8GHz +/- 75MHz
Transmission power	<2mW
Detection range	Max. (Ø x H) 12m x 5m
Detection angle	30° ~ 150°
Sensitivity	10% / 50% / 75% / 100%
Hold time	30s ~ 30min (selectable)
Daylight threshold	2 ~ 50 lux, disabled
Stand-by period	0s ~ 1h, +∞ (selectable)
Stand-by dimming level	5% / 10% / 20% / 50%

Environment

Operation temperature	Ta: -35°C ~ +70°C
Case temperature (Max.)	Tc: +80°C
IP rating	IP20

Mechanical Structure & Dimensions

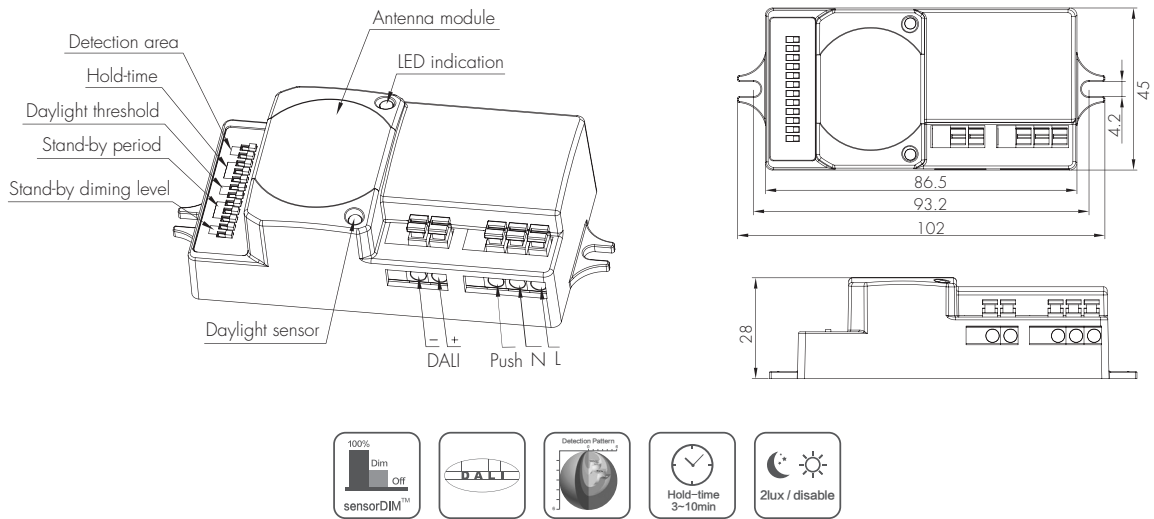

Note: We recommend the mounting distance between sensor to sensor should be more than 2m to prevent sensors from false-triggering.

This sensor is specially designed for small scale, decentralised retrofit project, which contains a DALI power supply circuit and gives DALI output to the DALI driver to carry out on/off and dimming command. No extra DALI power supply is needed.

Wiring Diagram

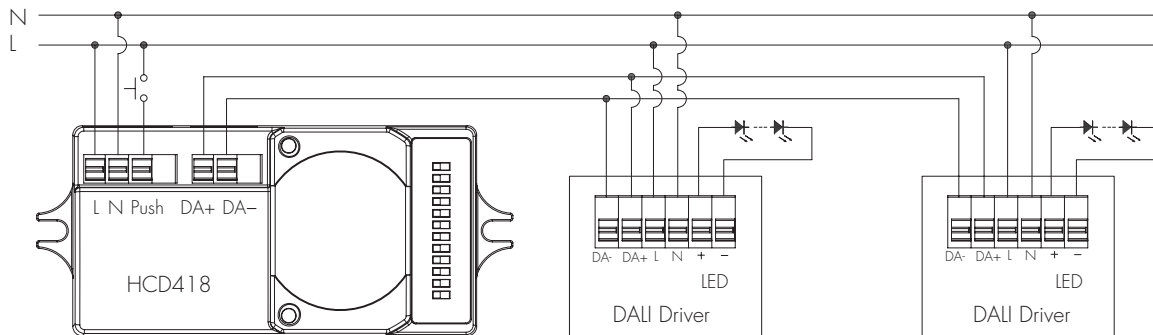

Detection Pattern

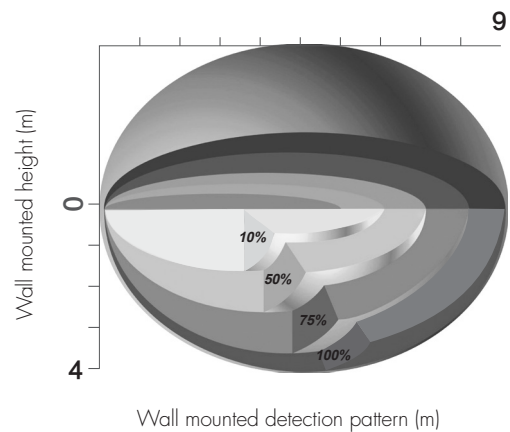
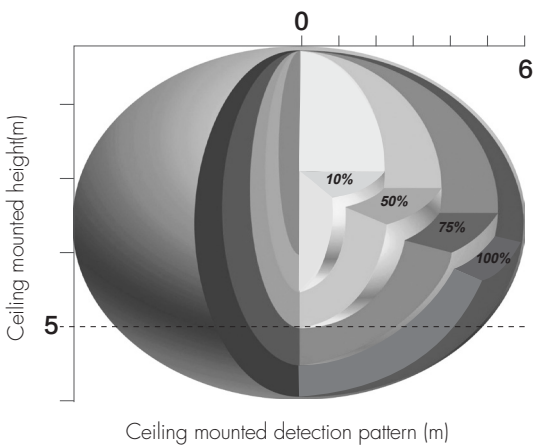

1 Tri-level Control (Corridor Function)

Hytronik builds this function inside the motion sensor to achieve tri-level control, for some areas which require a light change notice before switch-off. The sensor offers 3 levels of light: 100%→dimmed light →off; and 2 periods of selectable waiting time: motion hold-time and stand-by period; Selectable daylight threshold and freedom of detection area.

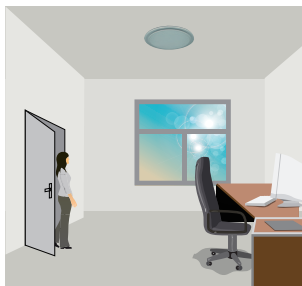

With sufficient natural light, the light does not switch on when presence is detected.

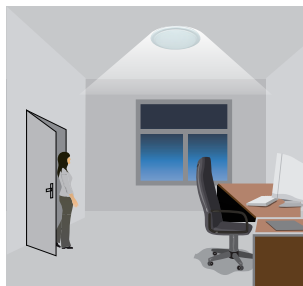

With insufficient natural light, the sensor switches on the light automatically when presence is detected.

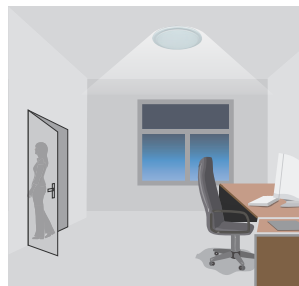

After hold-time, the light dims to stand-by level preset.

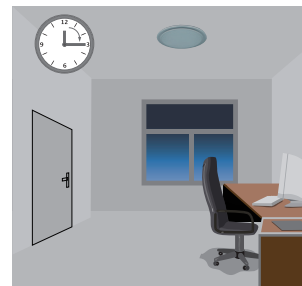

Light switches off automatically after the stand-by period elapses.

2 Manual Override

This sensor reserves the access of manual override function for end-user to switch on/off, or adjust the brightness by push-switch, which makes the product more user-friendly and offers more options to fit some extra-ordinary demands:

* Short Push (< 1 s): on/off function;

On → Off: the light turns off immediately and cannot be triggered ON by motion until the expiration of pre-set hold-time. After this period, the sensor goes back to normal sensor mode.

Off → On: the light turns on and goes to sensor mode, no matter if ambient Lux level exceeds the daylight threshold or not.

* Long Push (> 1 s): adjust the hold-time brightness level between 10% and 100%.

Note: if end-user do not want this manual override function, just leave the "push" terminal unconnected to any wire.

DIP Switch Settings

1 Detection Range

Sensor sensitivity can be adjusted by selecting the combination on the DIP switches to fit precisely for each specific application.

	1	2	
I	●	●	100%
II	●	○	75%
III	○	●	50%
IV	○	○	10%



I – 100%
II – 75%
III – 50%
IV – 10%

2 Hold Time

Select the DIP switch configuration for the light on-time after presence detection. This function is disabled when natural light is sufficient.

	1	2	3	
I	●	●	●	Test
II	●	●	○	30s
III	●	○	●	1min
IV	●	○	○	5min
V	○	●	●	10min
VI	○	●	○	20min
VII	○	○	○	30min



I – Test
II – 30s
III – 1min
IV – 5min
V – 10min
VI – 20min
VII – 30min

3 Daylight Threshold

Set the level according to the fixture and environment. The light will not turn on if ambient lux level exceeds the daylight threshold preset.

Please note that the ambient lux level refers to internal light reaching the sensor.

Disabling the daylight sensor will put the sensor into occupancy detection only mode.

	1	2	
I	●	●	Disable
II	●	○	50Lux
III	○	●	10Lux
IV	○	○	2Lux



I – Disable
II – 50Lux
III – 10Lux
IV – 2Lux

4 Stand-by period (corridor function)

This is the time period you would like to keep at the low light output level before it is completely switched off in the long absence of people.

Note: "0s" means on/off control; "+∞" means the stand-by period is infinite and the light never switches off but stays at dimming level.

	1	2	3	
I	●	●	●	0s
II	●	●	○	10s
III	●	○	●	1min
IV	●	○	○	5min
V	○	●	●	10min
VI	○	●	○	30min
VII	○	○	●	1H
VIII	○	○	○	+∞



I – 0s
II – 10s
III – 1min
IV – 5min
V – 10min
VI – 30min
VII – 1H
VIII – +∞

5 Stand-by dimming level

The setting is used to select the desired dimmed light level used in periods of absence for enhanced comfort and safety.

	1	2	
I	●	●	5%
II	●	○	10%
III	○	●	20%
IV	○	○	50%



I – 5%
II – 10%
III – 20%
IV – 50%

Additional Information / Documents

- Regarding precautions for microwave sensor installation and operation, please kindly refer to www.hytronik.com/download ->knowledge ->Microwave Sensors - Precautions for Product Installation and Operation
- Regarding Hytronik standard guarantee policy, please refer to www.hytronik.com/download ->knowledge ->Hytronik Standard Guarantee Policy