

Product Description

HBEM038 is a wireless DALI/Bluetooth convertor with 30mA DALI power supply built in, which converts a standard DALI/DALI2 emergency driver output to Bluetooth output. It can work with a wide range of microwave and PIR sensor heads by plug and play. In the meantime, it enables users to manage and customize monthly functional and annual duration tests based on the Koolmesh Emergency system. The high-end Koolmesh platform provides powerful and convenient features, for users, they can effortlessly view, edit, and oversee the entire emergency system; for features, scheduling a monthly self-test or annual self-test in the app, checking the DALI/DALI2 emergency drivers' status, including automatic email notification upon detecting the fault, automatic monthly/annually (functional/duration test) emergency report generation, etc. All the settings and parameters can be set in Koolmesh app, all the information such as reports can be viewed and downloaded from Koolmesh IoT platform.



In addition, HBEM038 can control serval DALI/DALI2 DT6 or DT8 drivers at the same time.

App Features

- Quick setup mode & advanced setup mode
- Web app/platform for project deployment & data analysis
- Koolmesh Pro app on iPad for on-site configuration
- Floorplan feature to simplify project planning
- D4i supported
- One-key device replacement
- Device social relations check
- Staircase function (primary & secondary)
- Remote control via gateway support HBGW01
- Heat map
- Dynamic daylight harvest auto-adaptation
- Grouping luminaires via mesh network
- Scenes
- Dusk/Dawn photocell (Twilight function)
- Tri-level control
- Daylight harvest
- Push switch configuration
- Detailed motion sensor settings
- Schedule
- Astro timer (sunrise and sunset)
- Power-on status (memory against power loss)
- Offline commissioning
- Bulk commissioning (copy and paste settings)
- Different permission levels via authority management
- Network sharing via QR code or keycode

- Interoperability with Hytronik Bluetooth product portfolio
- Compatible with EnOcean BLE switches
- Internet-of-Things (IoT) featured
- Device firmware update over-the-air (OTA)
- Continuous development in progress...

Hardware Features

- DALI bus power supply:
I guaranteed:30mA
I max:80mA
- Plug'n'Play for flexible installation and cost saving assemble
- Support to control DT8 LED drivers
- 2 Push inputs for flexible manual control
- 5-year warranty

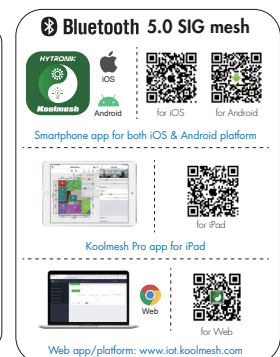
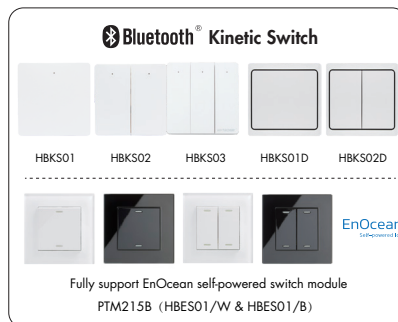

Note:

1. 1pc HBEM038 convertor for 1pc 3rd party DALI/DALI2 emergency driver.
2. 1pc HBEM038 convertor can control serval DALI/DALI2 DT6 or DT8 drivers at the same time.
3. With Bluetooth gateway HBGW01, users can remotely control and monitor emergency system via Koolmesh mobile/tablet app & web app platform.
4. HBEM038 & 3rd Party standard DALI/DALI2 emergency driver does not need to connect to central DALI PSU.
5. HBEM038 provides power supply to the 3rd party standard DALI/DALI2 emergency driver and DT6 or DT8 drivers.

Technical Specifications

Bluetooth Transceiver	
Operation frequency	2.4 GHz - 2.483 GHz
Transmission power	4 dBm
Range (Typical indoor)	10~30m
Protocol	Bluetooth® 5.0 SIG Mesh

Safety & EMC	
EMC standard (EMC)	EN55015, EN61000, EN61547
Safety standard (LVD)	EN60669-1, EN60669-2-1
RED	EN300328, EN301489-1/-17
Certification	Semko, CB, CE, EMC, RED, RCM

Input & Output Characteristics	
Operating voltage	220~240VAC 50/60Hz
Stand-by power	<1W
Warming-up	20s

Environment	
Operation temperature	Ta: -20°C ~ +55°C
Case temperature (Max.)	Tc: +75°C
IP rating	IP20

DALI Bus Power Supply	
I guaranteed	30mA
I max	80mA

Mechanical Structure & Dimensions

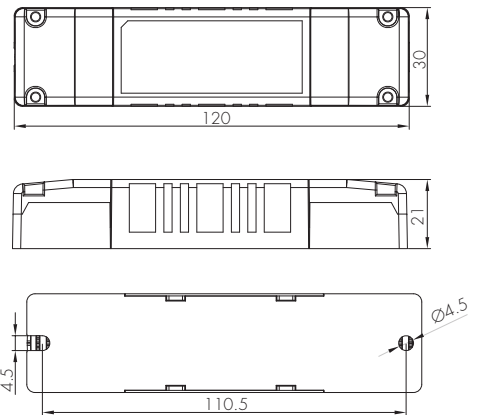
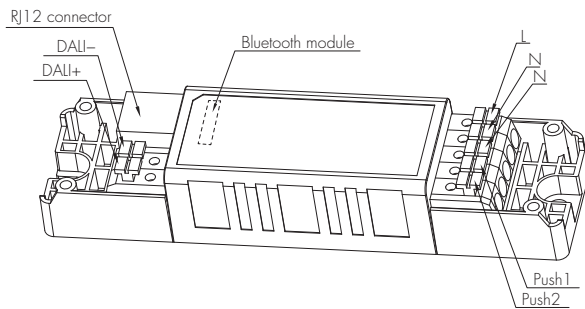

Wire Preparation

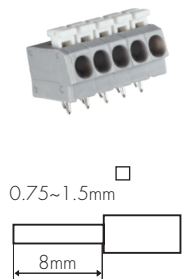

To make or release the wire from the terminal, use a screwdriver to push down the button.

Wiring Diagram

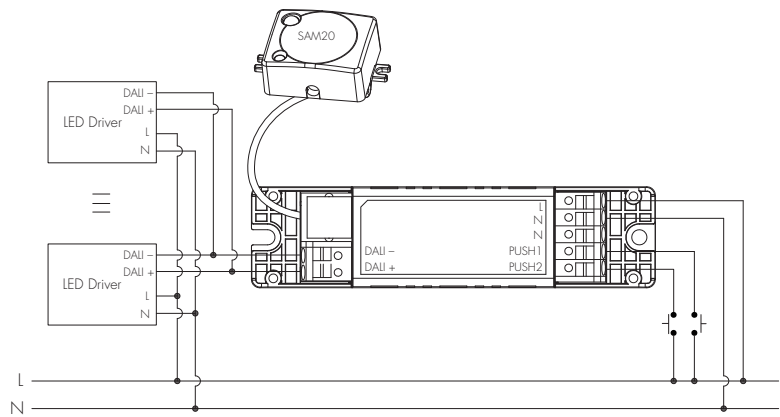

Technical Specifications for Sensor Heads

PIR Sensor Properties		
Sensor principle	PIR detection	
Operating voltage	5VDC	
Detection range *	HIRO5 & HIRO5/FM HIRO5/AA & HIRO7	Max installation height: 3m; Max detection range: 6m (diameter)
	HIR11	Max installation height: 15m (forklift); 12m (single person); Max detection range: 24m (diameter)
	HIR12	Max installation height: 15m (forklift); 12m (single person); Max detection range: 18*6m (L*W)
	HIR63	Max installation height: 3m; Max detection range: 12m (diameter)
	HIR63/R	Max installation height: 12m (forklift); 8m (single person); Max detection range: 14m (diameter)

HF Sensor Properties		
Sensor principle	High Frequency (microwave)	
Operating voltage	5VDC	
Operation frequency	5.8GHz +/- 75MHz	
Transmission power	<0.2mW	
Detection range *	SAM20 & SAM21 SAM22 & SAM22/AA	Max installation height: 3m; Max detection range: 12m (diameter)
	SAM23	Max installation height: 15m (forklift); 12m (single person); Max detection range: 20m (diameter)

* The detection range is heavily influenced by sensor placement (angle) and different walking paces. It may be reduced under certain conditions.

PIR & microwave sensor heads

The range of PIR and microwave sensor heads below offers powerful number of Plug'n'Play feature options to expand the flexibility of luminaire design. This approach to luminaire design reduces space requirements and component costs whilst simplifying production.

A. HIRO5

PIR sensor head
The cable length is around 30cm.

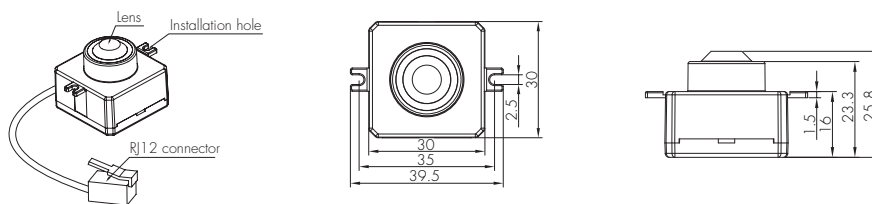

B. HIRO5/FM

PIR sensor head
The cable length is around 30cm.

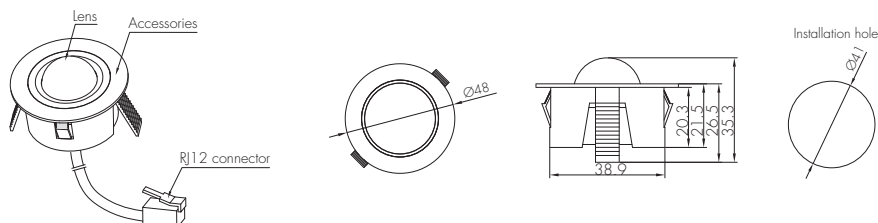

C. HIRO5/AA

PIR sensor head
Adjustable angle
The cable length is around 30cm.

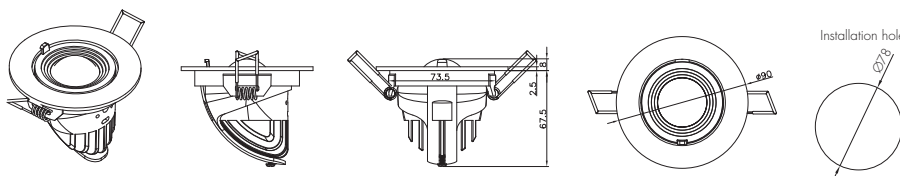

D. HIR07

PIR sensor head
 Photocell Advance™
 The cable length is around 30cm.

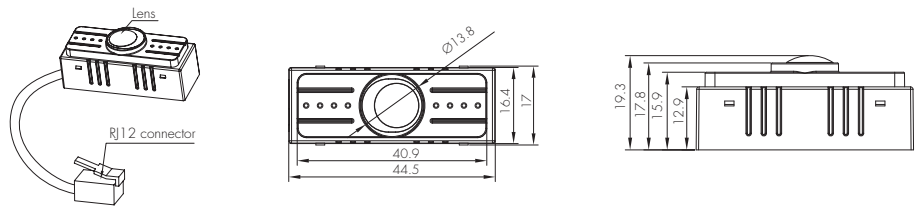

E. HIR11/S

PIR sensor head
 Surface mounting
 For highbay application
 IP65 (facia / lens part)
 The cable length is around 30cm.

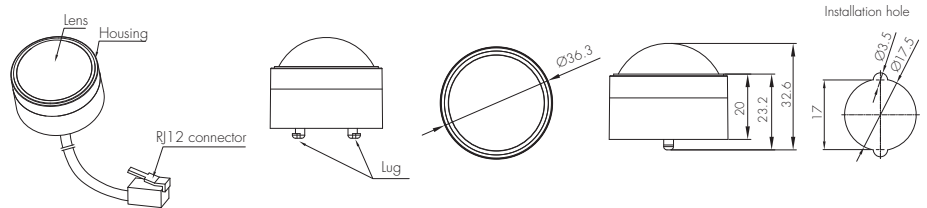

F. HIR11/F

PIR sensor head
 Flush mounting
 For highbay application
 IP65 (facia / lens part)
 The cable length is around 30cm.

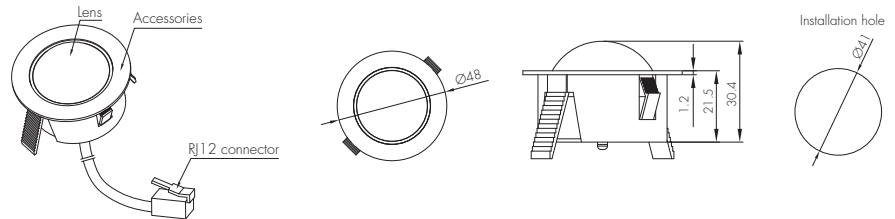

G. HIR11/C

PIR sensor head
 Screw to the luminaire by conduit
 For highbay application
 IP65 (facia / lens part)
 The cable length is around 30cm.

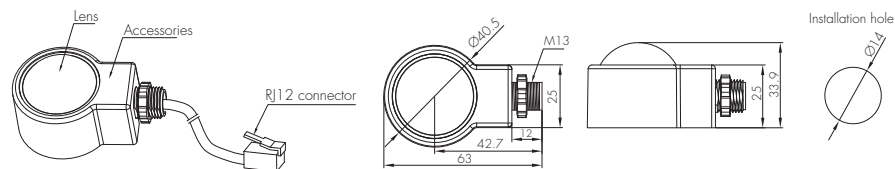

H. HIR12

PIR sensor head
 For highbay application
 IP65 (facia / lens part)
 The cable length is around 30cm.

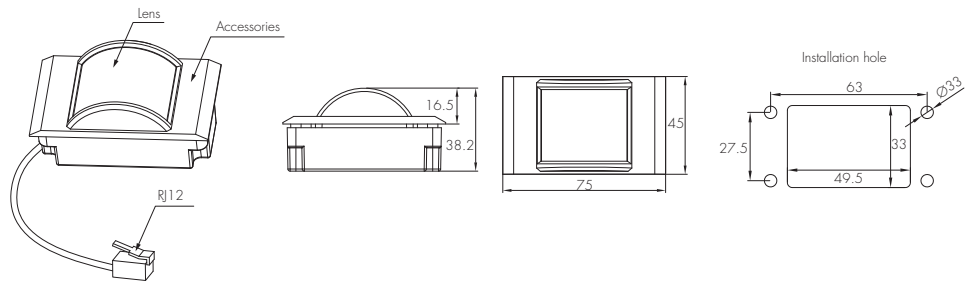

Installation for HIR12



We suggest that the metal plate thickness to be 0.8mm - 1.6mm to ensure perfect focal length for the PIR lens.

I. HIR63

PIR sensor head
 The cable length is around 30cm.

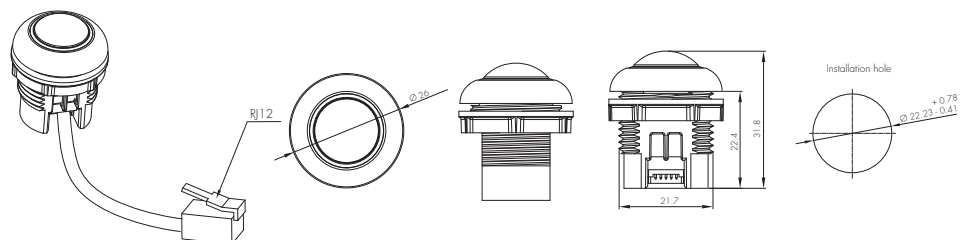

J. HIR63 with HA04
 PIR sensor head
 Optional accessory
 The cable length is around 30cm.

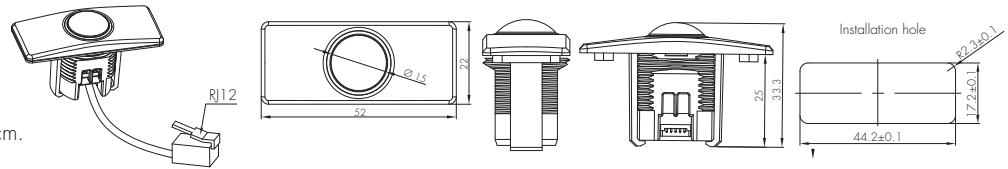

K. HIR63 with HA05
 PIR sensor head
 Optional accessory
 The cable length is around 30cm.

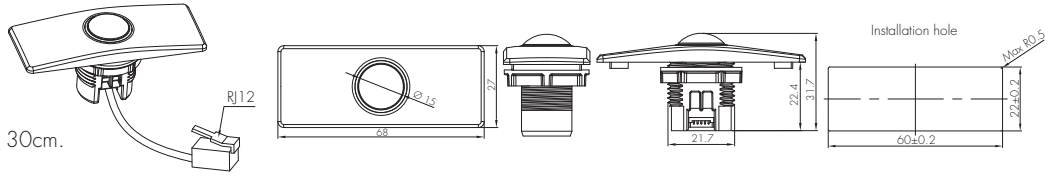

L. HIR63/R
 PIR sensor head
 IP65 (facia / lens part)
 The cable length is around 30cm.

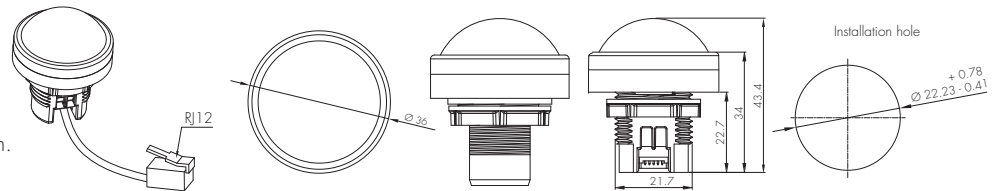

M. SAM20
 HF sensor head
 Photocell Advance™
 The cable length is around 30cm.

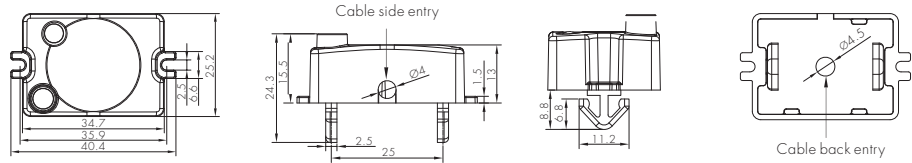

N. SAM21
 HF sensor head
 IP65
 The cable length is around 30cm.

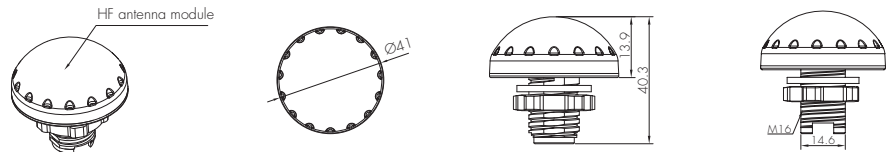

O. SAM22
 HF sensor head
 Flush mount
 The cable length is around 30cm.

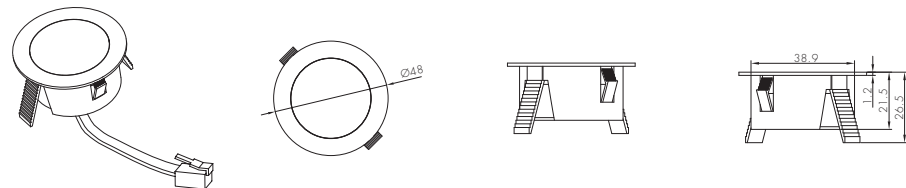

P. SAM22/AA
 HF sensor head
 Adjustable angle
 The cable length is around 30cm.

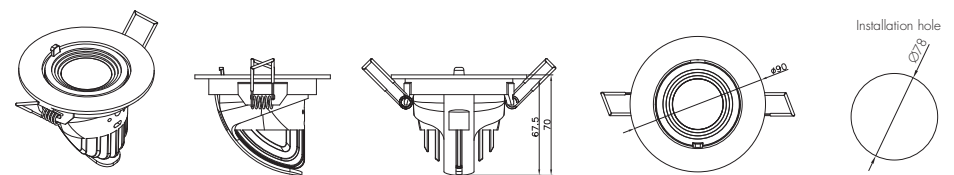

Q. SAM23
 HF sensor head
 Photocell advance™
 Daylight sensor
 For highbay application
 The cable length is around 30cm.

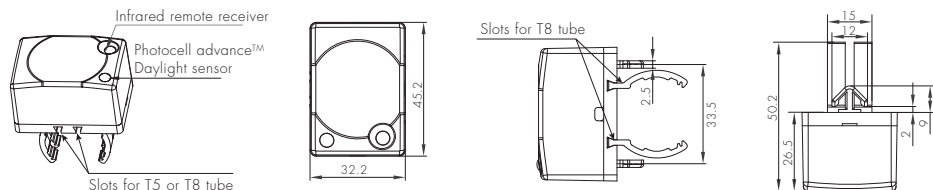

Optional Accessory: Reinforced Bluetooth Antenna

For some special applications, customers may need a larger Bluetooth transmission for both smartphone to device and device to device. Thanks to the reinforced Bluetooth antenna (optional black or white color to choose from), with it being added to the control base HBEM038, the transmission distance (smartphone to device) enlarges to 20m, the distance of device to device is around 50m.



HA01B

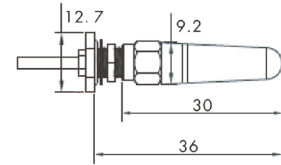
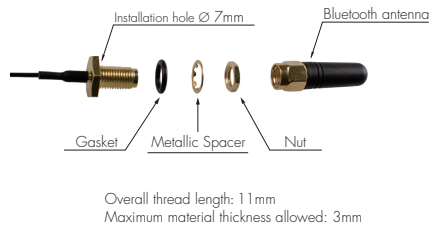

HA01W

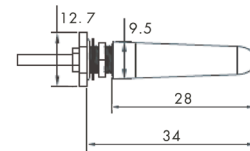
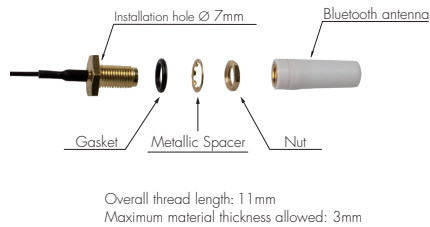

Installation Method



Solder the antenna to the Bluetooth module



Drill a 7mm hole in the fixture
Assemble the antenna parts in turn



Make sure the antenna head is outside the fixture

Detection Pattern

SAM23

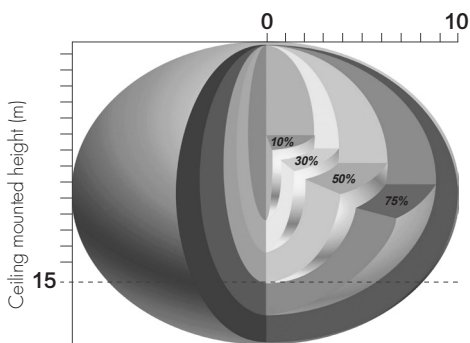

Ceiling mounted detection pattern (m)

SAM20 & SAM21 & SAM22 & SAM22/AA

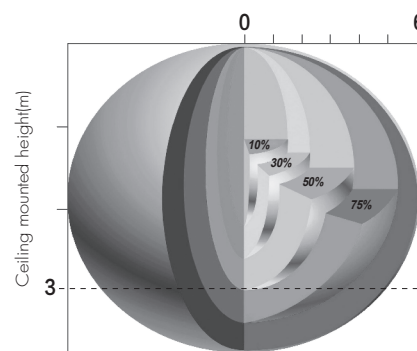

Ceiling mounted detection pattern (m)

HIRO5 & HIRO5/FM & HIRO5/AA & HIRO7

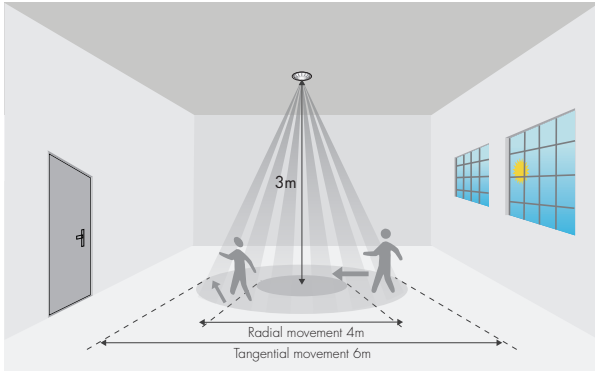

HIR12

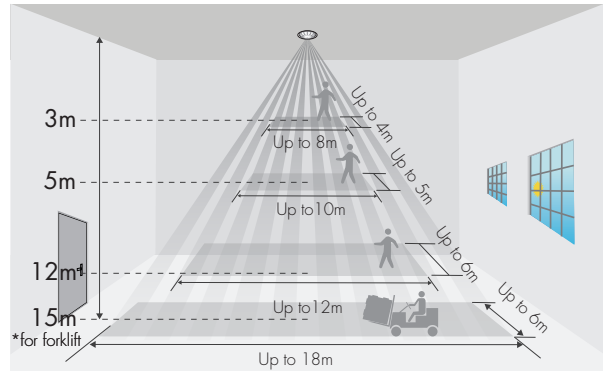

HIR63

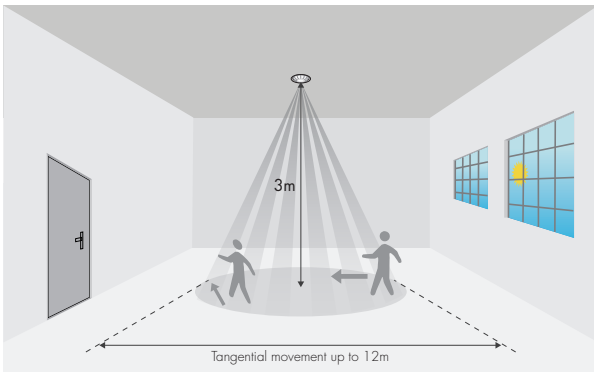

HIR63/R

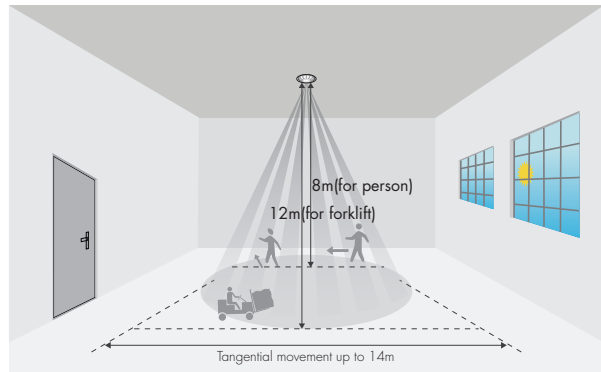

*The detection patterns are based upon 5km/h movement speed.

HIR11 (High-bay)



HIR11: High-bay lens detection pattern for forklift @ Ta = 20°C
(Recommended installation height 10m-15m)

A: Tangential movement	B: Radial movement	Mount height	Tangential (A)	Radial (B)
		10m	max 380m ² (Ø = 22m)	max 201m ² (Ø = 16m)
		11m	max 452m ² (Ø = 24m)	max 201m ² (Ø = 16m)
		12m	max 452m ² (Ø = 24m)	max 201m ² (Ø = 16m)
		13m	max 452m ² (Ø = 24m)	max 177m ² (Ø = 15m)
		14m	max 452m ² (Ø = 24m)	max 133m ² (Ø = 13m)
		15m	max 452m ² (Ø = 24m)	max 113m ² (Ø = 12m)



HIR11: High-bay lens detection pattern for single person @ Ta = 20°C
(Recommended installation height 2.5m-12m)

A: Tangential movement	B: Radial movement	Mount height	Tangential (A)	Radial (B)
		2.5m	max 50m ² (Ø = 8m)	max 7m ² (Ø = 3m)
		6m	max 104m ² (Ø = 11.5m)	max 7m ² (Ø = 3m)
		8m	max 154m ² (Ø = 14m)	max 7m ² (Ø = 3m)
		10m	max 227m ² (Ø = 17m)	max 7m ² (Ø = 3m)
		11m	max 269m ² (Ø = 18.5m)	max 7m ² (Ø = 3m)
		12m	max 314m ² (Ø = 20m)	max 7m ² (Ø = 3m)

Normal Mode

It is the mode in which mains supply is available, with the battery charged or charging. In this mode, if there is no motion sensor head is plugged, then it is a standard Bluetooth dimmer with DALI broadcasting function; if there is a motion sensor head is plugged, then it will be a standard built-in Bluetooth motion sensor with DALI broadcasting function. Both conditions are with ability to create scenes and controllable by motion sensor, Push switch, schedules and app.

Emergency Mode

It is the mode in which mains supply has failed and whilst the control gear is powered by the battery until deep discharge point. In this mode, HBEMO38 is unable to be controlled by motion sensor, Push switch, schedules and app. However, some emergency parameters can still be conjured via the app, such as time scheduled for self-test, duration for extended emergency mode etc.

Rest Mode

It's the mode in which the luminaires are intentionally off whilst the control gear is powered by the battery. To enter this mode, the prerequisite is that there is no mains supply. In this mode, the luminaires will be turned off automatically and HBEMO38 is powered by the battery. If the luminaires are forced to turn on in this mode, HBEMO38 will then be adjusted to emergency mode. When mains supply is recovered, HBEMO38 will return to normal mode.

Inhibit Mode

It is the mode in which HBEMO38 is powered from mains but prevented from going into emergency mode in the event mains failure. Please enter this mode only in special applications whereby emergency functions is not needed, such as when electricians need to cut off power supply when doing examinations and maintenance work of HBEMO38.

Extended Emergency Mode

It is the mode in which the control gear continues to operate the luminaires in the same way as in emergency mode for the programmed prolong time after the restorations of the mains supply. When this mode is enabled, HBEMO38 will remain in emergency mode even when mains supply is recovered. In this mode, the user must set the time extended for emergency mode; when the time extended elapses, HBEMO38 will return to normal mode.

Self test (Monthly)

HBEMO38 carries out routine test on emergency lighting based on pre-programmed time via the app & web app platform or after receiving manual commands from the app & web app platform. During the self test process, tests for load connections (such as open circuit, short-circuit) and battery connections (such as open circuit, short-circuit, polarity reversal etc.) will be carried out.

All the DALI emergency drivers Self Test feedbacks, results and related Events (Such as the open circuit and short circuit of the load connection, open circuit and short circuit for battery connection) are generated by the driver itself, the HBEMO38 convertor will only retrieve the data from the emergency driver and translate the DALI feedback into Bluetooth Mesh data correctly and accurately and display to the end user interface (App and Web app Platform). It will not contain any Emergency Self Test circuit in the products itself.

Self test (Annually)

The test is carried out mainly to check the battery level. The user must make sure that the battery for DALI emergency driver is fully charged before HBEMO38 carries out annual test. Also, the battery lifetime statistics will be analysed and displayed on a chart basis.

Push switch function

Users can connect Push switch to HBEMO38 to achieve multiple functions such as manually trigger monthly self test, annually self test, invalid and back to normal mode. Those options can be selected in Koolmesh app Push switch settings.

Dimming Interface Operation Notes

Switch-Dim

The provided Switch-Dim interface allows for a simple dimming method using commercially available non-latching (momentary) wall switches. Detailed Push switch configurations can be set on Koolmesh app.

Switch Function	Action	Descriptions
Push switch	Short press (<1 second) * Short press has to be longer than 0.1s, or it will be invalid.	- Turn on/off - Recall a scene - Turn on only - Quit manual mode - Turn off only - Do nothing
	Double push	- Turn on only - Quit manual mode - Turn off only - Do nothing - Recall a scene
	Long press (≥1 second)	- Dimming - Colour tuning - Do nothing
Sensorlink	/	- Upgrade a normal on/off motion sensor to a Bluetooth controlled motion sensor
Emergency Self-Test Function	Short press (<1 second) * Short press has to be longer than 0.1s, or it will be invalid.	- Start Self test (Monthly) - Stop Self test - Start Self test (Annually) - Invalid
	Long press (≥1 second)	- Start Self test (Monthly) - Stop Self test - Start Self test (Annually) - Invalid
Fire Alarm (VFC signal only)	Refer to Koolmesh™ App User Manual V2.1	- Able to connect the Fire Alarm system - Once the fire alarm system is triggered, all the luminaries controlled by the Push Switch will enter the preset scene (normally it's full on), after the fire alarm system gives the ending signal, all the luminaries controlled by this Push Switch will revert back to normal status.

Additional Information / Documents

- For full explanation of Hytronik Photocell Advance™ technology, please kindly refer to [www.hytronik.com/download ->knowledge ->Introduction of Photocell Advance](http://www.hytronik.com/download->knowledge->Introduction%20of%20Photocell%20Advance)
- To learn more about detailed product features/functions, please refer to [www.hytronik.com/download ->knowledge ->Introduction of App Scenes and Product Functions](http://www.hytronik.com/download->knowledge->Introduction%20of%20App%20Scenes%20and%20Product%20Functions)
- Regarding precautions for Bluetooth product installation and operation, please kindly refer to [www.hytronik.com/download ->knowledge ->Bluetooth Products - Precautions for Product Installation and Operation](http://www.hytronik.com/download->knowledge->Bluetooth%20Products%20-%20Precautions%20for%20Product%20Installation%20and%20Operation)
- Regarding precautions for microwave sensor installation and operation, please kindly refer to [www.hytronik.com/download ->knowledge ->Microwave Sensors - Precautions for Product Installation and Operation](http://www.hytronik.com/download->knowledge->Microwave%20Sensors%20-%20Precautions%20for%20Product%20Installation%20and%20Operation)
- Regarding precautions for PIR Sensors installation and operation, please kindly refer to [www.hytronik.com/download ->knowledge ->PIR Sensors - Precautions for Product Installation and Operation](http://www.hytronik.com/download->knowledge->PIR%20Sensors%20-%20Precautions%20for%20Product%20Installation%20and%20Operation)
- Data sheet is subject to change without notice. Please always refer to the most recent release on [www.hytronik.com/products/bluetooth technology ->DALI to Bluetooth Converter/Translator Module](http://www.hytronik.com/products/bluetooth%20technology->DALI%20to%20Bluetooth%20Converter/Translator%20Module)
- Regarding Hytronik standard guarantee policy, please refer to [www.hytronik.com/download ->knowledge ->Hytronik Standard Guarantee Policy](http://www.hytronik.com/download->knowledge->Hytronik%20Standard%20Guarantee%20Policy)