























## Product Description













This series is a Bluetooth dimming and color tuning LED driver with 40W to 80W max power output. It has a Switch-Dim interface via a Push switch. By connecting sensor heads like HIRO5, HIRO7, HIR11, HIR12, HIR63, HIR63/R, SAM20, SAM21, SAM22, SAM23 to the driver, it enables motion detection and Bluetooth mesh control. It is ideal for direct projects or new luminaire designs for lighting manufacturers. With Bluetooth wireless mesh networking, it makes communication between luminaires much easier without time-consuming hardwiring, which eventually saves costs for projects. Meanwhile, simple device setup and commissioning can be done via **Koolmesh**® app.



## App Features

-  Quick setup mode & advanced setup mode
-  Web app/platform for project deployment & data analysis
-  Koolmesh Pro app on iPad for on-site configuration
-  Floorplan feature to simplify project planning
-  One-key device replacement
-  Device social relations check
-  Staircase function (primary & secondary)
-  Remote control via gateway support HBGW series
-  Heat map
-  Grouping luminaires via mesh network
-  Scenes
-  Push switch configuration
-  Schedule
-  Astro timer (sunrise and sunset)
-  Power-on status (memory against power loss)
-  Offline commissioning
-  Bulk commissioning (copy and paste settings)
-  Different permission levels via authority management
-  Network sharing via QR code or keycode
-  Interoperability with Hytronik Bluetooth product portfolio
-  Compatible with EnOcean BLE switches
-  Internet-of-Things (IoT) featured
-  Device firmware update over-the-air (OTA)
-  Continuous development in progress...

## Hardware Features

-  Switch-Dim with two Push inputs
-  Flicker free (1-100%)
-  Tunable white
-  Standby power <0.5W
-  Active PFC design
-  Logarithmic Dimming
-  Linear Dimming
-  Configurable constant current (CC) output via DIP switch
-  Short-circuit Protection
-  Overload Protection
-  Open-circuit Protection
-  5-year warranty

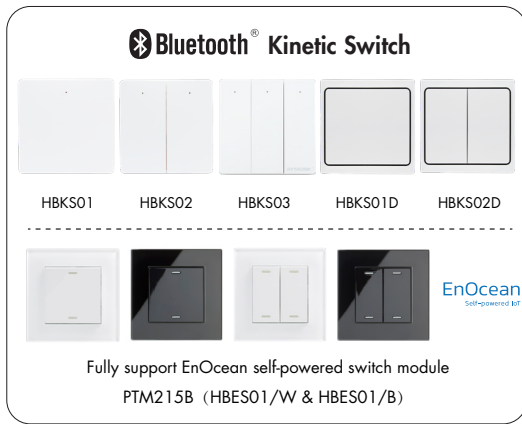

## Output Configuration

HED8040/BT, 1x40W

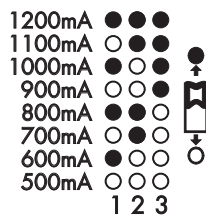

HED8060/BT, 1x60W

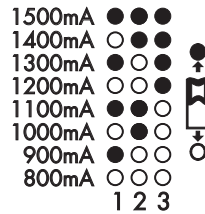

HED8080/BT, 1x80W

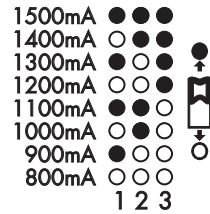

⚠ Warning: Please make sure the correct current is selected before starting the driver!

## Technical Specifications

	Model No.	HED8040/BT	HED8060/BT	HED8080/BT
Input	Input Voltage	220~240VAC 50/60Hz	220~240VAC 50/60Hz	220~240VAC 50/60Hz
	Input Current	210~190mA	310~280mA	425~385mA
	Power Factor	0.95	0.95	0.95
	Input Power	45W	68W	93W
	Max. Efficiency	88%	88%	88%
Output	Ripple Current	<3%	<3%	<3%
	Uout Max.	60V	60V	100V
	Turn-on Time	<0.5s	<0.5s	<0.5s
	Stand-by Power	<0.5W	<0.5W	<0.5W
	Dimming Interface	Switch-Dim	Switch-Dim	Switch-Dim
Environment	Operation Temp.	-20 ~ +50°C	-20 ~ +50°C	-20 ~ +50°C
	Case Temp. (Max.)	80°C	80°C	80°C
	Operating Humidity	10~90%	10~90%	10~90%
	Storage Temperature	-40~+70°C	-40~+70°C	-40~+70°C
	IP Rating	IP20	IP20	IP20
	Protection Class	Class I	Class I	Class I

Safety and EMC	EMC Standard	EN55015 EN61547 EN61000-3-2/-3-3
	Safety Standard	EN61347-1 EN61347-2-13
	RED	EN300 328 EN301489-1/-17 EN50663
	Dielectric strength	Input→output: 3000VAC / 5mA / 1min
	Abnormal protection	Output short-circuit protection, Open-circuit protection, Overload protection

Model No.	Max. output power/current/voltage range			
HED8040/BT	10-23W/ 500mA /20-46V	12-28W/ 600mA /20-46V	14-32W/ 700mA /20-46V	16-37W/ 800mA /20-46V
	18-40W/ 900mA /20-44V	20-40W/1000mA/20-40V	22-40W/ 1100mA /20-36V	
	24-40W/ 1200mA /20-33V			
HED8060/BT	16-37W/800mA /20-46V	18-42W/ 900mA /20-46V	20-46W/ 1000mA /20-46V	22-51W/ 1100mA /20-46V
	24-55W/ 1200mA /20-46V	26-60W/1300mA /20-46V	28-60W/ 1400mA /20-43V	30-60W/ 1500mA /20-40V
HED8080/BT	16-52W/800mA /20-65V	18-58.5W/ 900mA /20-65V	20-65W/ 1000mA /20-65V	
	22-71.5W/1100mA /20-65V	24-78W/ 1200mA /24-65V	26-78W/ 1300mA /24-60V	
	28-78.4W/1400mA /20-56V	30-81W/ 1500mA /20-54V		

## Mechanical Structure & Dimensions

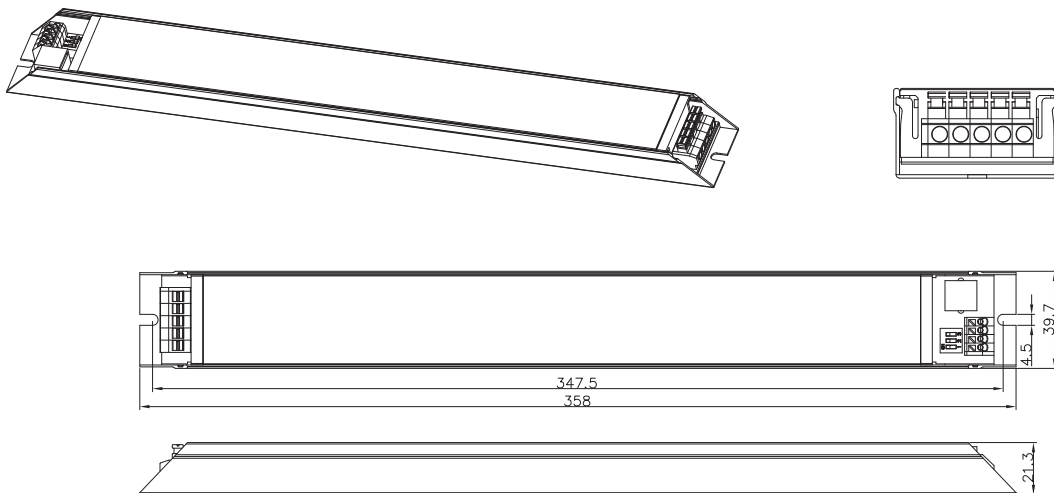
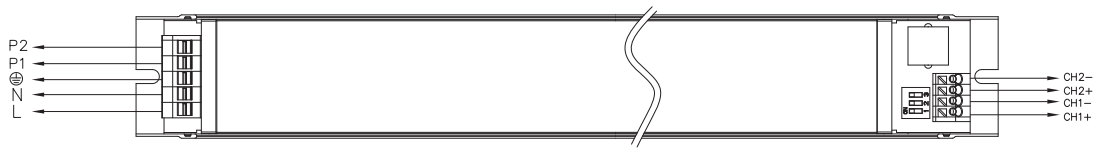

## Wire Preparation



To make or release the wire from the terminal, use a screwdriver to push down the button.

## Wiring Diagram

Model: HED8040/BT HED8060/BT HED8080/BT

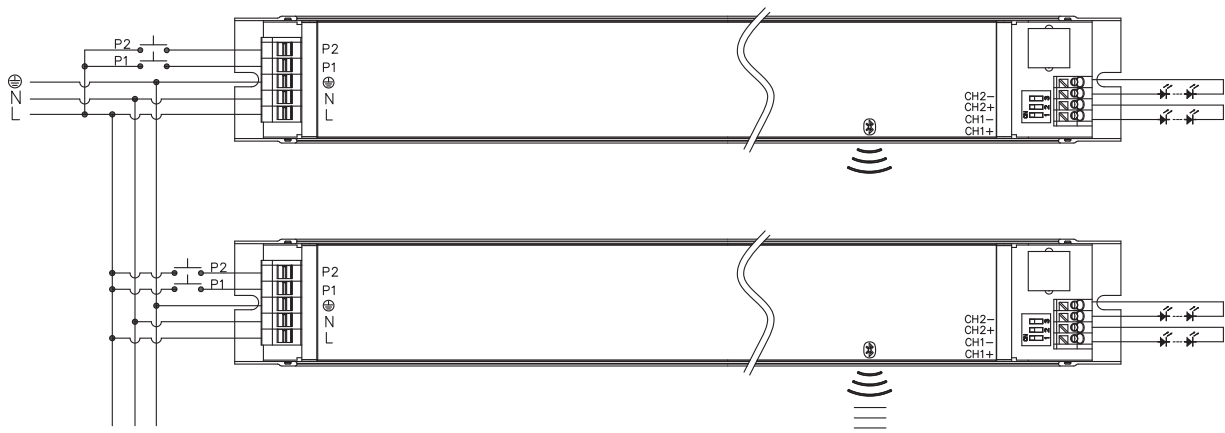

## Loading and In-rush Current

Model	HED8040/BT	HED8060/BT	HED8080/BT
In-rush Current (I <sub>max.</sub> )	25.3A	25.3A	30A
Pulse Time	56μs	56μs	400μs

## Circuit Breaker Information

Automatic circuit breaker type	B16A	B10A	B13A	B20A	B25A
HED8040/BT	46	29	38	58	73
HED8060/BT	31	19	25	38	48
HED8080/BT	23	15	19	29	36

The data above is calculated according to the formula: Maximum Amount =  $16 / (P_n / 230)$ . In order to provide a more reliable reference in real application, the data have been revised to take 60% of the number calculated, i.e.  $16 / (P_n / 230) \times 60\%$ . Please kindly take note that the calculation is based on ABB circuit breaker series S200. Actual values may differ due to different types of circuit breaker used and installation environment.

# Performance Characteristics

HED8040/BT

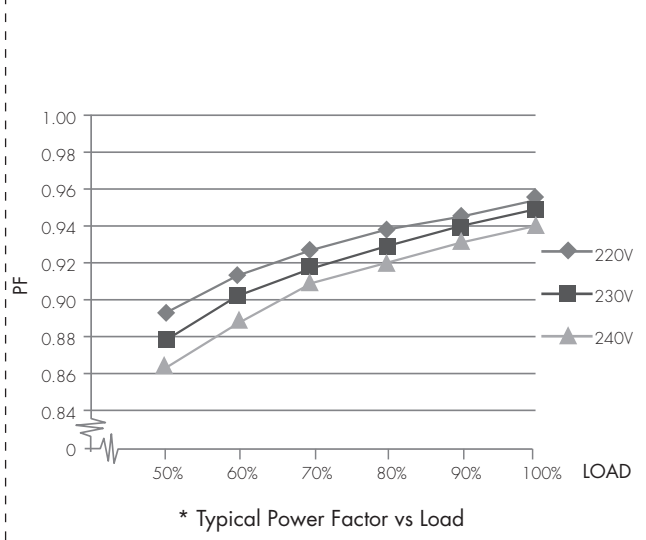
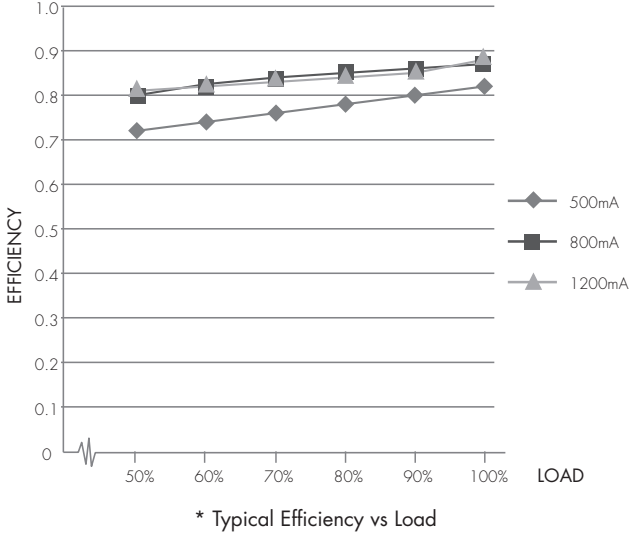

HED8060/BT

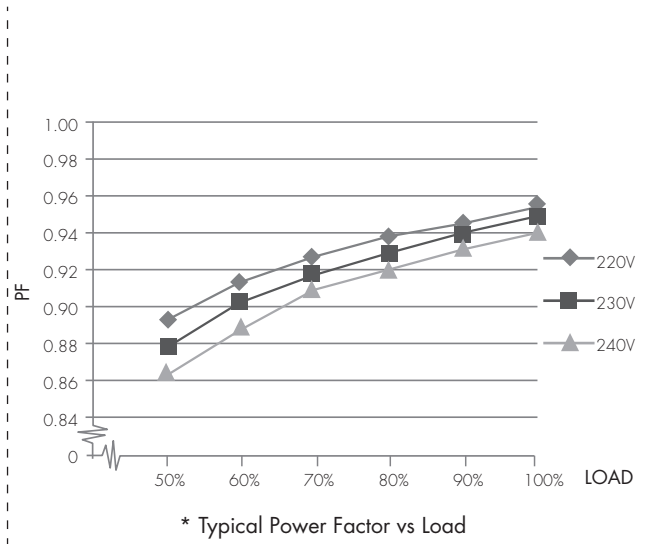
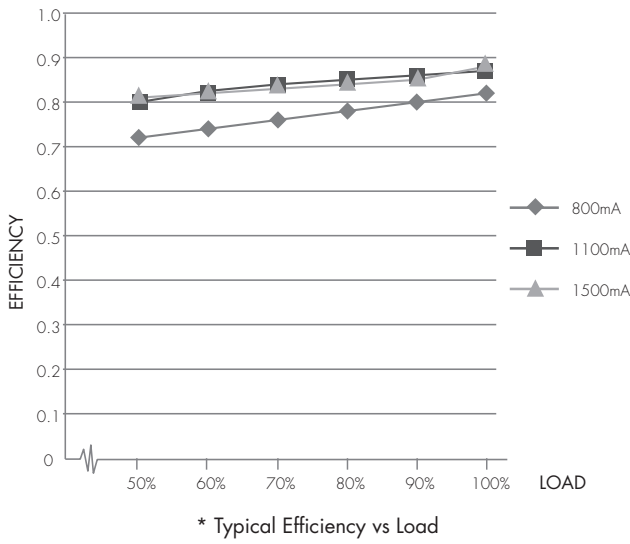

HED8080/BT

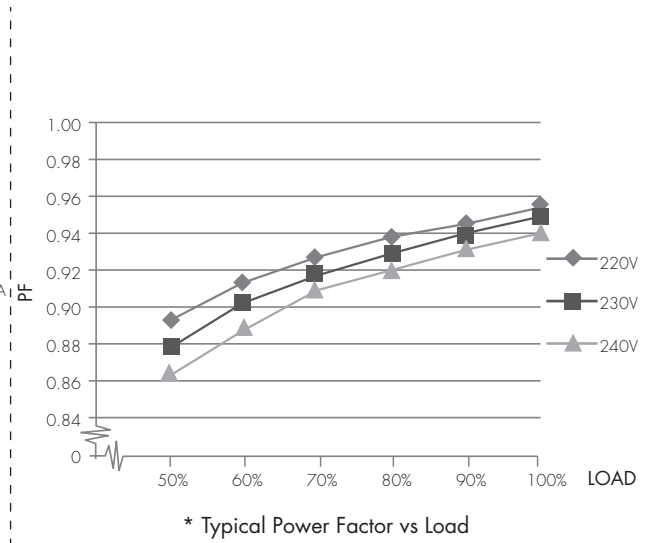
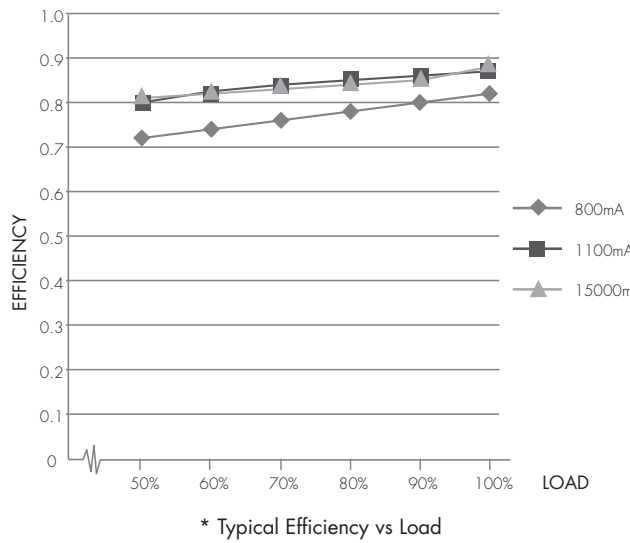

## Dimming Characteristics

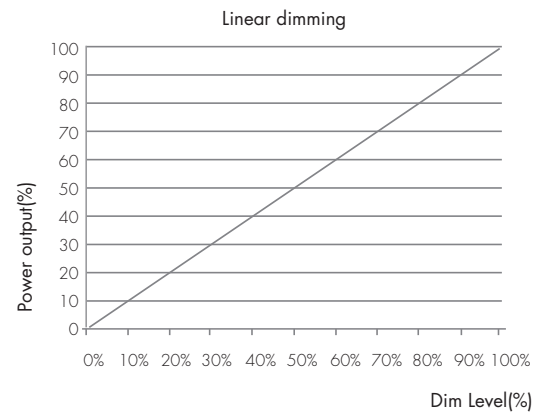
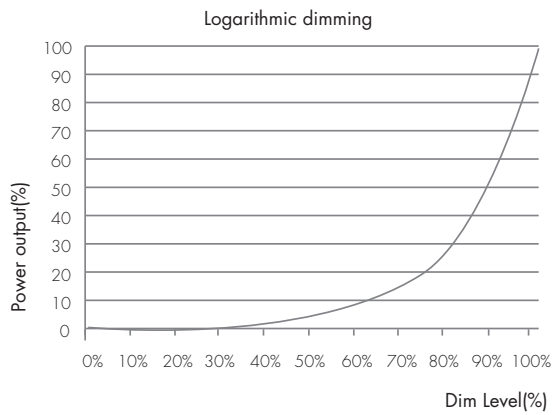

## Technical Specifications for Sensor Heads

PIR Sensor Properties		
Sensor principle	PIR detection	
Operating voltage	5VDC	
Detection range *	HIRO5 & HIRO5/FM & HIRO7	Max installation height: 3m; Max detection range: 6m (diameter)
	HIR11	Max installation height: 15m (forklift); 12m (single person); Max detection range: 24m (diameter)
	HIR12	Max installation height: 15m (forklift); 12m (single person); Max detection range: 18m*6m (L*W)
	HIR63	Max installation height: 3m; Max detection range: 12m (diameter)
	HIR63/R	Max installation height: 12m (forklift); 8m (single person); Max detection range: 14m (diameter)

HF Sensor Properties		
Sensor principle	High Frequency (microwave)	
Operating voltage	5VDC	
Operation frequency	5.8GHz +/- 75MHz	
Transmission power	<0.2mW	
Detection range *	SAM20 & SAM21 SAM22	Max installation height: 3m; Max detection range: 12m (diameter)
	SAM23	Max installation height: 15m (forklift); 12m (single person); Max detection range: 20m (diameter)

\* The detection range is heavily influenced by sensor placement (angle) and different walking paces. It may be reduced under certain conditions.

## PIR & microwave sensor heads

The range of PIR and microwave sensor heads below offers powerful number of Plug'n'Play feature options to expand the flexibility of luminaire design. This approach to luminaire design reduces space requirements and component costs whilst simplifying production.

### A. HIRO5

PIR sensor head  
The cable length is around 65cm.

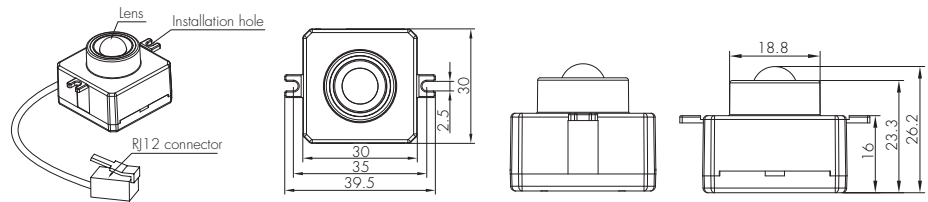

### B. HIRO5/FM

PIR sensor head  
The cable length is around 65cm.

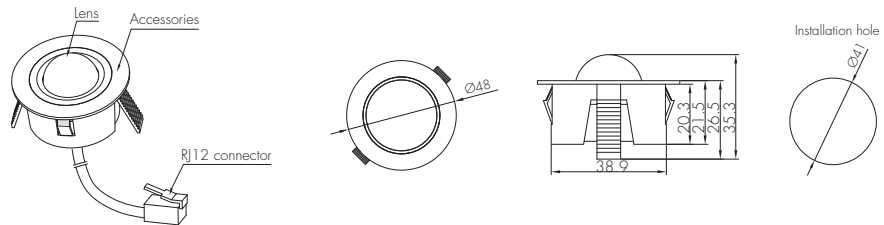

### C. HIRO7

PIR sensor head  
Photocell Advance™  
The cable length is around 30cm.

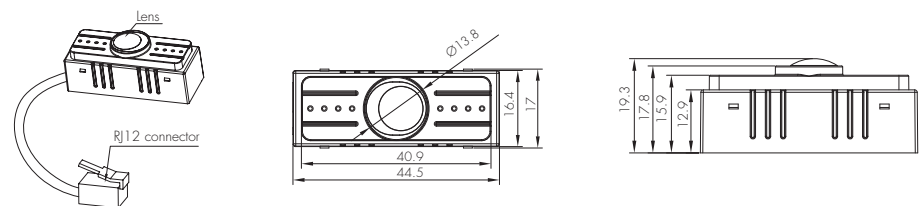

### D. HIR11/S

PIR sensor head  
Surface mounting  
For highbay application  
IP65 (facia / lens part)  
The cable length is around 65cm.

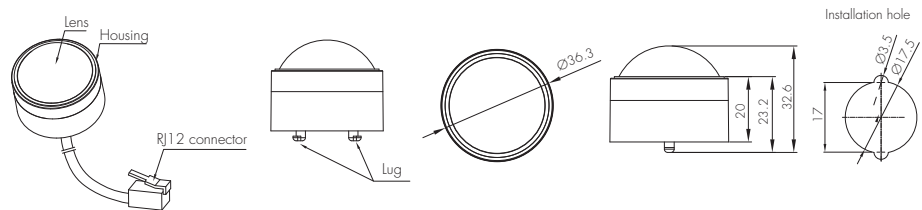

### E. HIR11/F

PIR sensor head  
Flush mounting  
For highbay application  
IP65 (facia / lens part)  
The cable length is around 65cm.

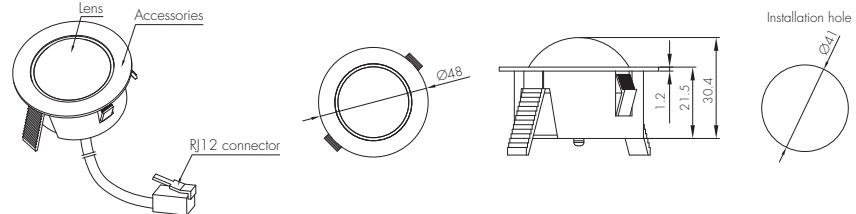

### F. HIR11/C

PIR sensor head  
Screw to the luminaire by conduit  
For highbay application  
IP65 (facia / lens part)  
The cable length is around 65cm.

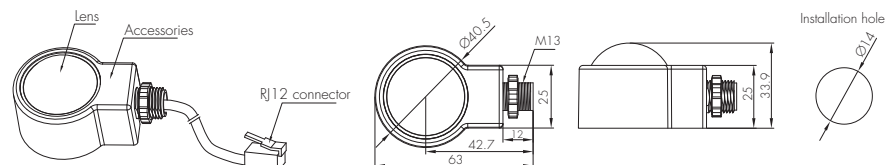

**G. HIR12**

PIR sensor head  
 For highbay application  
 IP65 (facia / lens part)  
 The cable length is around 65cm.

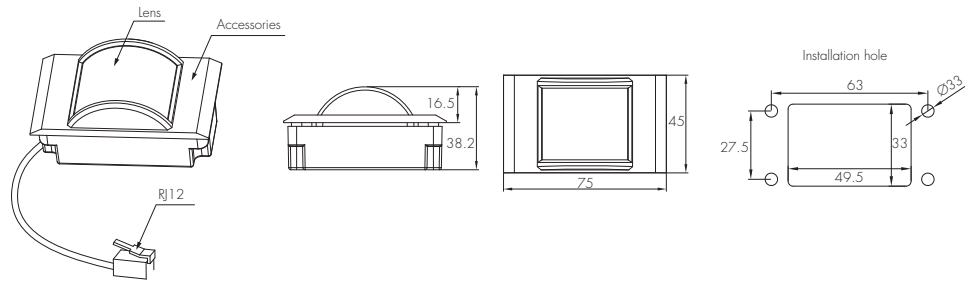

**Installation for HIR12**

We suggest that the metal plate thickness to be 0.8mm - 1.6mm to ensure perfect focal length for the PIR lens.

**H. HIR63**

PIR sensor head  
 The cable length is around 30cm.

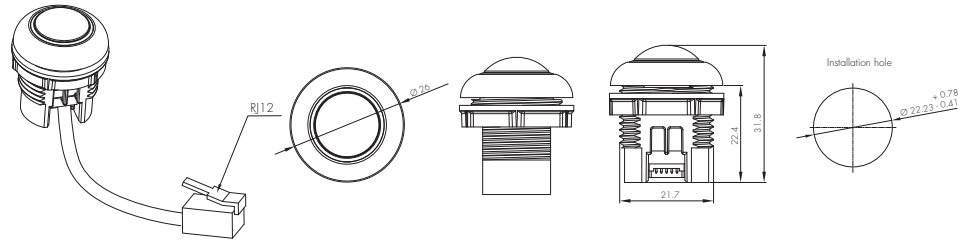

**I. HIR63 with HA04**

PIR sensor head  
 Optional accessory  
 The cable length is around 30cm.

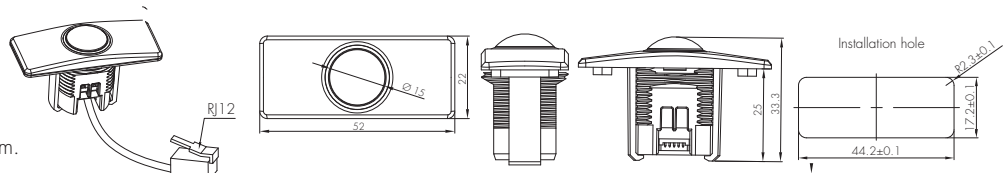

**J. HIR63 with HA05**

PIR sensor head  
 Optional accessory  
 The cable length is around 30cm.

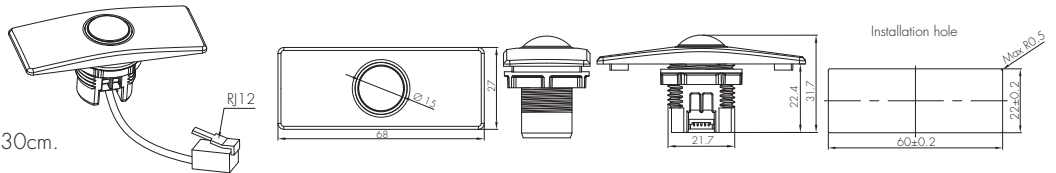

**K. HIR63/R**

PIR sensor head  
 IP65 (facia / lens part)  
 The cable length is around 30cm.

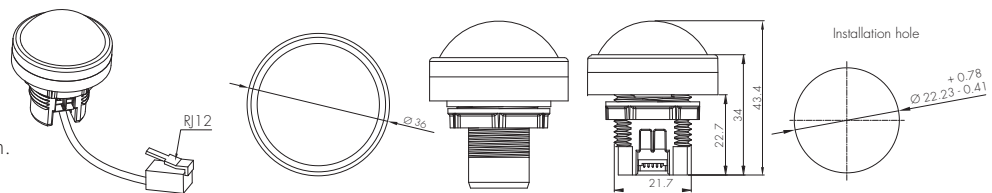





## HIR11 (High-bay)



**HIR11: High-bay lens detection pattern for forklift @ Ta = 20°C**  
**(Recommended installation height 10m-15m)**

A: Tangential movement	B: Radial movement	Mount height	Tangential (A)	Radial (B)
		10m	max 380m <sup>2</sup> (Ø = 22m)	max 201m <sup>2</sup> (Ø = 16m)
		11m	max 452m <sup>2</sup> (Ø = 24m)	max 201m <sup>2</sup> (Ø = 16m)
		12m	max 452m <sup>2</sup> (Ø = 24m)	max 201m <sup>2</sup> (Ø = 16m)
		13m	max 452m <sup>2</sup> (Ø = 24m)	max 177m <sup>2</sup> (Ø = 15m)
		14m	max 452m <sup>2</sup> (Ø = 24m)	max 133m <sup>2</sup> (Ø = 13m)
		15m	max 452m <sup>2</sup> (Ø = 24m)	max 113m <sup>2</sup> (Ø = 12m)



**HIR11: High-bay lens detection pattern for single person @ Ta = 20°C**  
**(Recommended installation height 2.5m-12m)**

A: Tangential movement	B: Radial movement	Mount height	Tangential (A)	Radial (B)
		2.5m	max 50m <sup>2</sup> (Ø = 8m)	max 7m <sup>2</sup> (Ø = 3m)
		6m	max 104m <sup>2</sup> (Ø = 11.5m)	max 7m <sup>2</sup> (Ø = 3m)
		8m	max 154m <sup>2</sup> (Ø = 14m)	max 7m <sup>2</sup> (Ø = 3m)
		10m	max 227m <sup>2</sup> (Ø = 17m)	max 7m <sup>2</sup> (Ø = 3m)
		11m	max 269m <sup>2</sup> (Ø = 18.5m)	max 7m <sup>2</sup> (Ø = 3m)
		12m	max 314m <sup>2</sup> (Ø = 20m)	max 7m <sup>2</sup> (Ø = 3m)

### HIRO5 & HIRO5/FM & HIRO7

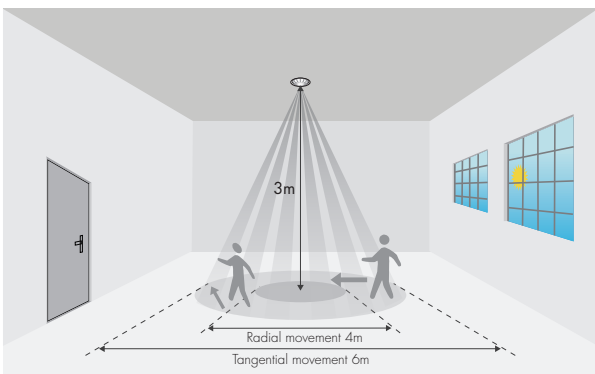

### HIR12

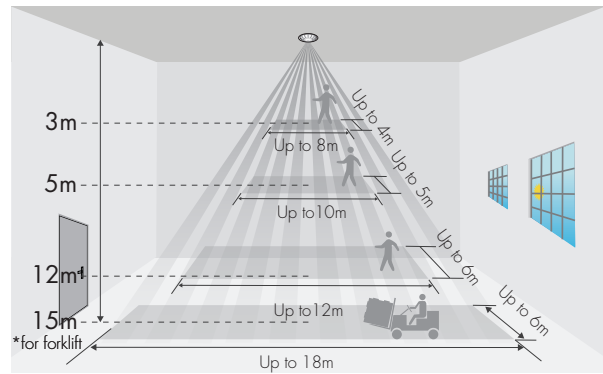

HIR63

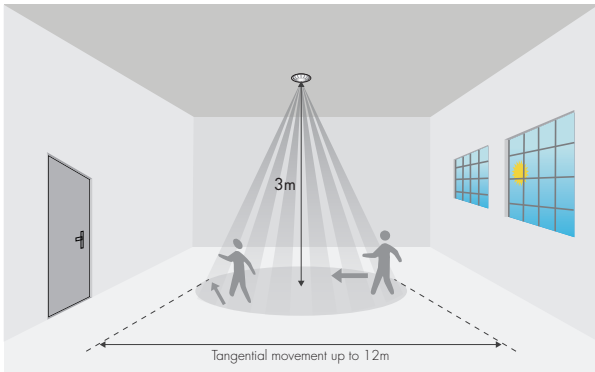

HIR63/R

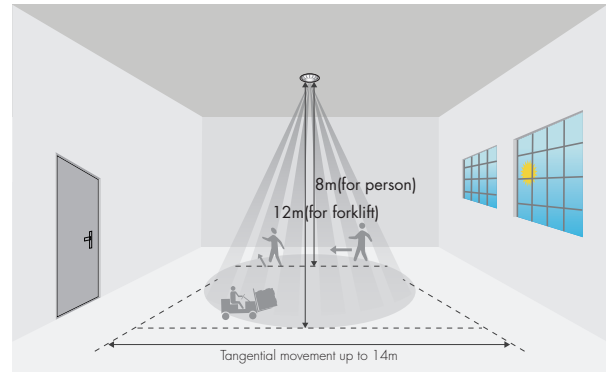

\*The detection patterns are based upon 5km/h movement speed.

### Dimming Interface Operation Notes

#### Switch-Dim

The provided Switch-Dim interface allows for a simple dimming method using commercially available non-latching (momentary) wall switches. Up to 64 LED drivers may be connected to one switch. Detailed Push switch configurations can be set on Koolmesh app.

Switch Function	Action	Descriptions
Push switch	Short press (<1 second) * Short press has to be longer than 0.1s, or it will be invalid.	- Turn on/off - Recall a scene - Turn on only - Quit manual mode - Turn off only - Do nothing
	Double push	- Turn on only - Quit manual mode - Turn off only - Do nothing - Recall a scene
	Long press (≥1 second)	- Dimming - Colour tuning - Do nothing
Sensorlink	/	- Upgrade a normal on/off motion sensor to a Bluetooth controlled motion sensor
Emergency Self-Test Function	Short press (<1 second) * Short press has to be longer than 0.1s, or it will be invalid.	- Start Self test (Monthly) - Start Self test (Annually) - Stop Self test - Invalid
	Long press (≥1 second)	- Start Self test (Monthly) - Start Self test (Annually) - Stop Self test - Invalid
Fire Alarm (VFC signal only)	Refer to <b>Koolmesh™</b> App User Manual V2.1	- Able to connect the Fire Alarm system - Once the fire alarm system is triggered, all the luminaries controlled by the Push Switch will enter the preset scene (normally it's full on), after the fire alarm system gives the ending signal, all the luminaries controlled by this Push Switch will revert back to normal status.

## Additional Information / Documents

1. To learn more about detailed product features/functions, please kindly refer to <https://hytronik.com/product/hed8040-bt>
2. Regarding precautions for Bluetooth product installation and operation, please kindly refer to <https://hytronik.com/service/downloads> (Bluetooth Products Precautions for Product Installation and Operation)
3. Regarding precautions for LED Drivers installation and operation, please kindly refer to <https://hytronik.com/service/downloads> (LED Drivers Precautions for Product Installation and Operation)
4. Data sheet is subject to change without notice. Please always refer to the most recent release on <https://hytronik.com/products/led-drivers>
5. Regarding Hytronik standard guarantee policy, please kindly refer to <https://hytronik.com/service/downloads> (Guarantee Conditions document)