

## Daylight Harvest HF Sensor

HCD418/DH

Independent DALI sensor with Photocell Advance™

# HYTRONIK®

### Applications

Occupancy detector with daylight harvest suitable for building into the fixture:

- Office / Commercial Lighting
- Classroom

Use for new luminaire designs and installations

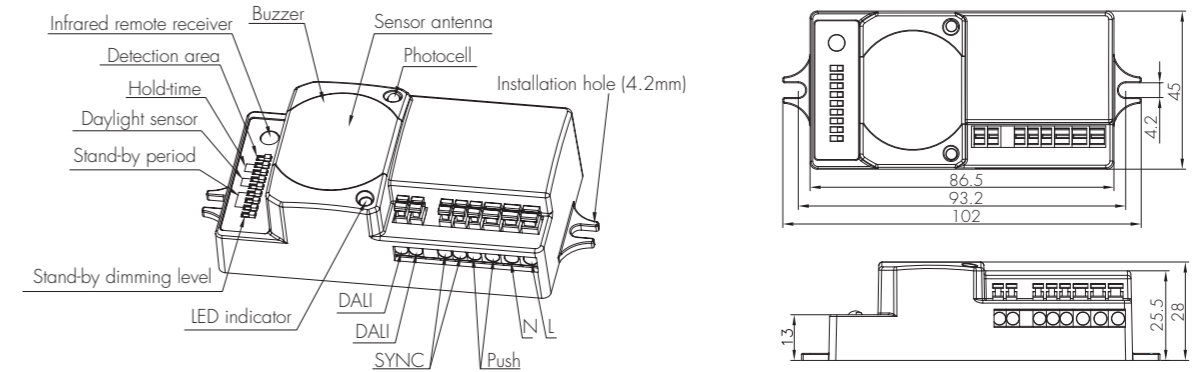

### Features

- ☯ Daylight harvest function to regulate light output for maintaining required lux level
- ☯ Special photocell to measure and differentiate natural light from LED light from behind the fixture cover
- ☯ Tri-level dimming control based upon occupancy (also known as corridor function)
- ☯ Synchronised dimming with multiple sensor circuits
- ☯ One-key commissioning via programmable remote control
- ☯ DALI dimming control method (DALI power supply circuit included)
- ☯ 5 Year, 50,000hr Warranty

### Technical Data

#### Input Characteristics

Model No.	HCD418/DH
Mains voltage	120~277VAC 50/60Hz
Stand-by power	<1W
Switched power	Max. 20 devices, 40mA
Warming-up	20s

#### Safety and EMC

EMC standard (EMC)	EN55015, EN61000
Safety standard (LVD)	EN60669, AS/NZS60669
Radio Equipment (RED)	EN300440, EN301489, EN62479
Certification	Semko, CB, CE, EMC, RED, RCM

CE emc RED CB IP20

#### Sensor Data

Model No.	HCD418/DH
Sensor principle	High Frequency (microwave)
Operation frequency	5.8GHz +/- 75MHz
Transmission power	<0.2mW
Detection range	Max. (Ø x H) 12m x 6m
Detection angle	30° ~ 150°
Setting adjustments:	
Sensitivity	50% / 100%
Hold time	5s ~ 30min (selectable)
Daylight threshold	2 ~ 50 lux, disabled
Stand-by period	0s ~ 1h, +∞ (selectable)
Stand-by dimming level	10% / 30%

#### Environment

Operation temperature	Ta: -20°C ~ +60°C
Case temperature (Max.)	Tc: +80°C
IP rating	IP20



This sensor is specially designed for small scale, decentralised retrofit project, which contains a DALI power supply circuit and gives DALI output to the DALI driver to carry out on/off and dimming command. No extra DALI power supply is needed.

### Functions and Features

#### 1 Photocell Advance™ Function

It's well known that LED lights have a totally different spectrum to natural light. Hytronik uses this principle and comes up with special photocell and sophisticated software algorithm to measure and differentiate natural light from LED light from behind the fixture cover, so that this photocell can ignore internal LED light and only respond to the natural light outside. Our technology has no infringement to the existing patents in the market.

#### 2 Daylight Harvest

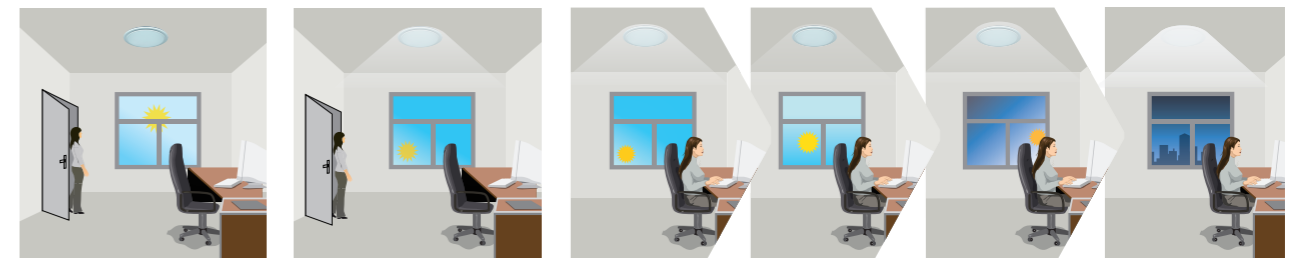

Light will not switch on when natural light is sufficient, even there is motion detected.

The light switches on automatically with presence when natural light is insufficient.

The light turns on at full or dims to maintain the lux level. The light output regulates according to the level of natural light available.

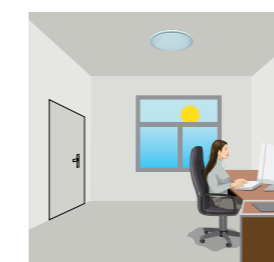

The light switches off when the ambient natural light is sufficient.

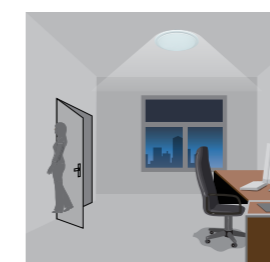

The light dims to stand-by period after hold-time and stays on selected minimum dimming level.



The light switches off completely after the stand-by period.

#### Note:

1. The light automatically turns on at target dim level or turns off based upon ambient natural light lux level during stand-by period if it is preset to '+∞'.
2. The target lux level can be adjusted by RC or a long press on the push switch.

### 3 Synchronisation Function

By connecting the "SYNC" terminals in parallel (maximum 10pcs, see wiring diagram), no matter which sensor detects motion, all HCD418/DH in the group will turn on the lights (ambient natural light is below daylight threshold). The detection area is widely enlarged in this way while other settings such as hold-time, stand-by period, stand-by dimming level and daylight threshold on each individual unit stay the same.

### 4 Manual Override

This sensor reserves the access of manual override function for end-user to switch on/off, or adjust the target lux level by push-switch, which makes the product more user-friendly and offers more options to fit some extra-ordinary demands:

- \* Short Push (< 1 s): on/off function;
  - On → Off: the light turns off immediately and cannot be triggered ON by motion until the expiration of pre-set hold-time. After this period, the sensor goes back to normal sensor mode.
  - Off → On: the light turns on and goes to sensor mode, no matter if ambient Lux level exceeds the daylight threshold or not.
- \* Long Push (> 1 s): adjust the target lux level by turning the light up or down. Both the adjustment on RC and push switch can overwrite each other, the last adjustment remains in memory.

*Note: if end-user do not want this manual override function, just leave the "push" terminal unconnected to any wire.*

### 5 Semi-auto Mode (Absence Detection)

It is easy to forget to switch off the light, in office, corridor, even at home. And in many other cases, people do not want to have a sensor to switch on the light automatically, for example, when people just quickly pass-by, there is no need to have the light on. The solution is to apply this "absence detector": motion sensor is employed, but only activated on the manual press of the push switch, the light keeps being ON in the presence, and dims down in the absence, and eventually switches off in the long absence.

This is a good combination of sensor automation and manual override control, to have the maximum energy saving, and at the same time, to keep efficient and comfortable lighting.

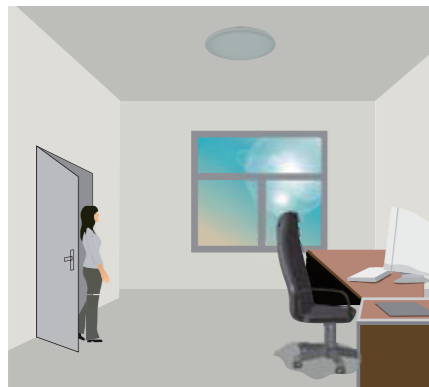

The light does not switch on when there is presence being detected.



Short push to activate the sensor and switch on the light

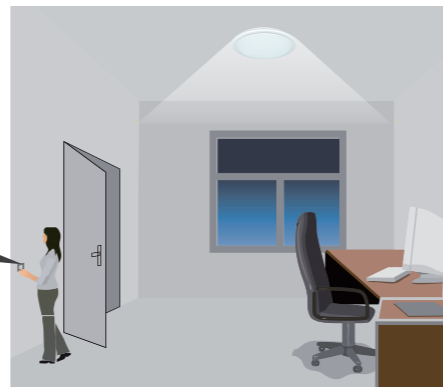

The light turns on full, and the sensor stays in sensor mode.

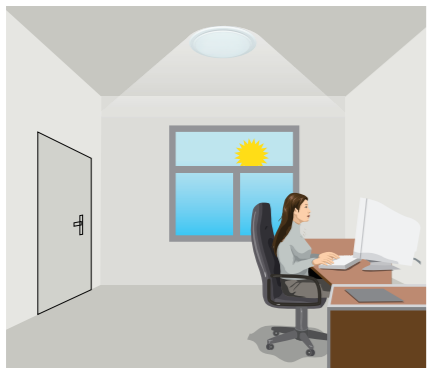

The light keeps being ON during the presence.

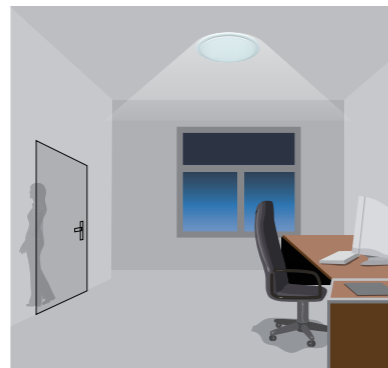

People left, the light dims to stand-by level after the hold-time.

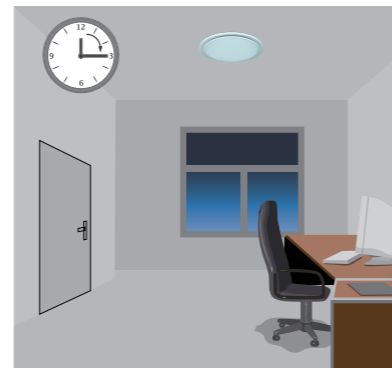

The light switches off automatically after the stand-by period elapses.

*Note: end-user can choose either function 4 or function 5 for application. Default function is manual override.*

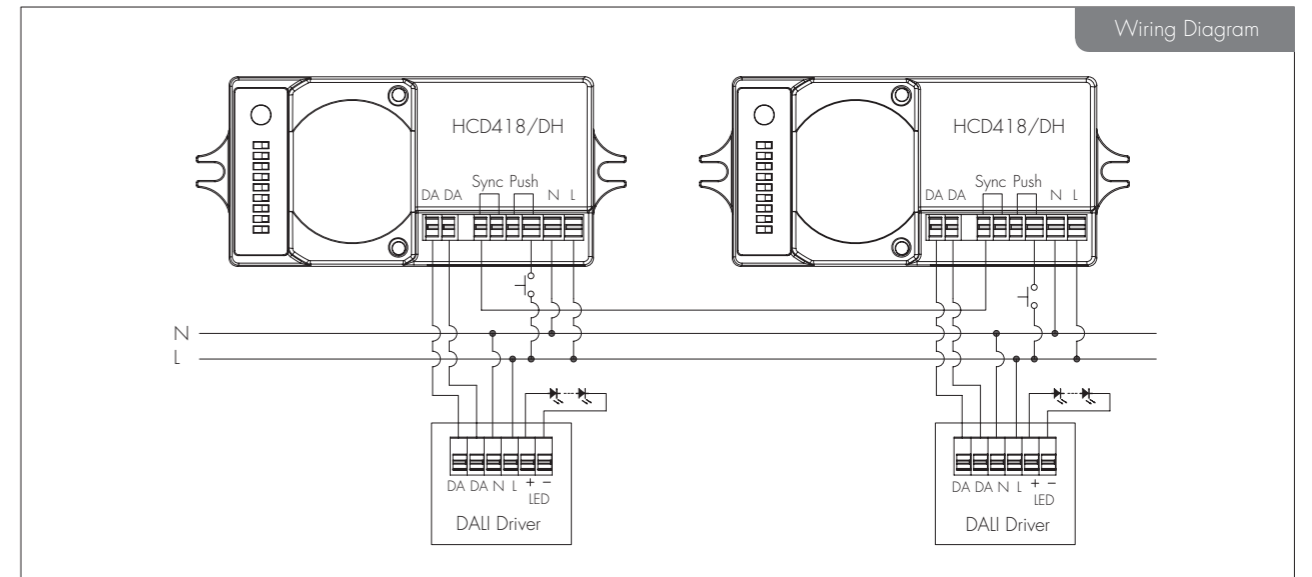

### Detection Pattern

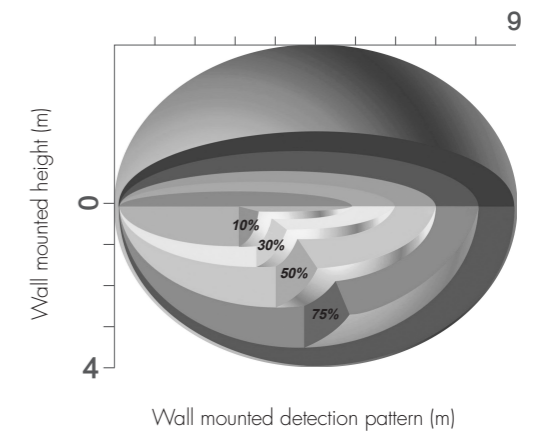
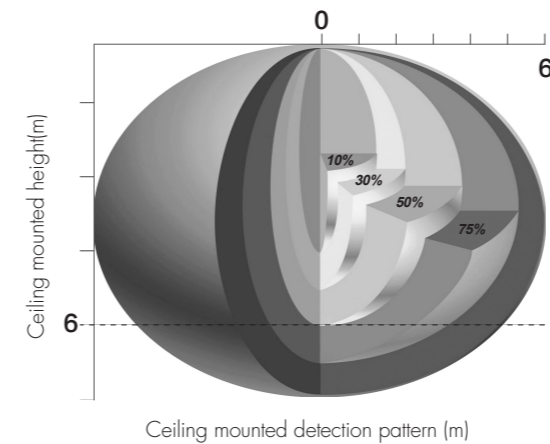

### DIP Switch Settings

#### 1 Detection Range

Sensor sensitivity can be adjusted by selecting the combination on the DIP switches to fit precisely for each specific application.

	I	100%	●
II	50%	○	○

I – 100%  
II – 50%

#### 2 Hold Time

Select the DIP switch configuration for the light on-time after presence detection. This function is disabled when natural light is sufficient.

	2	3	5s
I	●	●	3min
II	●	○	10min
III	○	●	30min
IV	○	○	

I – 5s  
II – 3min  
III – 10min  
IV – 30min

### 3 Daylight Threshold

Set the level according to the fixture and environment. The light will not turn on if ambient lux level exceeds the daylight threshold preset.

Please note that the ambient lux level refers to internal light reaching the sensor.

Disabling the daylight sensor will put the sensor into occupancy detection only mode.

	4	5	
I	●	●	Disable
II	●	○	50Lux
III	○	●	10Lux
IV	○	○	2Lux

- I – Disable
- II – 50Lux
- III – 10Lux
- IV – 2Lux

### 4 Stand-by period (corridor function)

This is the time period you would like to keep at the low light output level before it is completely switched off in the long absence of people.

Note: "0s" means on/off control;

"∞" means the stand-by period is infinite and the light is effectively controlled by the daylight sensor, off when natural light is sufficient and automatically on at dimming level when insufficient.

	6	7	8	
I	●	●	●	0s
II	●	●	○	10s
III	●	○	●	1min
IV	●	○	○	5min
V	○	●	●	10min
VI	○	●	○	30min
VII	○	○	●	1h
VIII	○	○	○	+∞

- I – 0s
- II – 10s
- III – 1min
- IV – 5min
- V – 10min
- VI – 30min
- VII – 1h
- VIII – ∞

### 5 Stand-by dimming level

The setting is used to select the desired dimmed light level used in periods of absence for enhanced comfort and safety.

	9	
I	●	10%
II	○	30%

- I – 10%
- II – 30%



### Power output

Press the buttons to select light output at 80% (at initial 10,000 hours) or 100%.

Note: "Sensor off" and "Twilight" functions are disabled.



### Brightness +/-

Press these two buttons to adjust the light output brightness and set a new target lux level. The built-in daylight sensor can measure ambient daylight level from behind the diffuser and calculates how much artificial light is needed to maintain the target lux level.



### Scene program - 1-key commissioning

1. Press button "Start" to program.
2. Select the buttons in "Detection range", "Daylight threshold", "Hold-time", "Stand-by time", "Stand-by dimming level" to set all parameters.
3. Press button "Memory" to save all the settings programmed in the remote control.
4. Press button "Apply" to set the settings to each sensor unit(s).  
For example, to set detection range 100%, daylight threshold Disable, hold-time 5min, stand-by time ∞, stand-by dimming level 30%, the steps should be: Press button "Start", button "100%", "Disable", "Shift", "5min", "Shift", "∞", "30%", "Memory". By pointing to the sensor unit(s) and pressing "Apply", all settings are passed on the sensor(s).

### Detection range

Press buttons in zone "Detection range" to set detection range at 100% / 75% / 50% / 10%.

### Daylight threshold

Press buttons in zone "Daylight threshold" to set daylight sensor at 2Lux / 10Lux / 50Lux / 100Lux / 300Lux / 500Lux / Disable.

Note: To set daylight sensor at 100Lux / 300Lux / 500Lux, press "Shift" button first.

### Ambient daylight threshold

1. Press button "Shift", the red LED starts to flash.
2. Press button "Ambient", the surrounding lux level is sampled and set as the new daylight threshold.

### Hold-time

Press buttons in zone "hold-time" to set the hold-time at 2s / 30s / 1min / 5min / 10min / 15min / 20min / 30min.

Note: 1. To set hold-time at 30s / 5min / 15min / 30min, press "Shift" button first.

2. 2s is for testing purpose only, stand-by period and daylight sensor settings are disabled in this mode.

\* To exit from Test mode, press button "RESET" or any button in "Hold-time".

### Stand-by time (corridor function)

Press buttons in zone "stand-by time" to set the stand-by period at 0s / 10s / 1min / 5min / 10min / 30min / 1h / ∞.

Note: "0s" means on/off control; "∞" means the stand-by time is infinite and the light is effectively controlled by the daylight sensor, off when natural light is sufficient and automatically on at dimming level when insufficient.

### Stand-by dimming level

Press the button in zone "stand-by dimming level" to set the stand-by dimming level at 10% / 20% / 30% / 50%.

### Daylight harvest auto-configuration

1. Press button "Shift", the red LED starts to flash.
  2. Select a time period and the sensor will do light level measurement and determine/save the lowest light level (commission line) with 100% light on, so as to set the target lux level automatically.
- Note: 1. Make sure the light level measurement covers the night time.  
2. The fixture will go into sensor mode after the measurement, all sensor setting remain unchanged.

### Dual tech & RF mode

All buttons in this zone are disabled.

## Settings (Remote Control HRC-11)



### Permanent ON/OFF function

Press button "ON/OFF" to select permanent ON or permanent OFF mode.

\* Press button "AUTO", "RESET" or "Ambient" to quit this mode.



### Reset Settings

Press button "RESET", all settings go back to DIP switch settings.



### Shift Button

Press button "Shift", the LED on the top left corner will flash to indicate mode selection. All values / settings in RED are valid for 20 seconds.



### AUTO mode

Press button "AUTO" to initiate automatic mode. The sensor starts working and all settings remain as before the light is switched ON/OFF.



### SEMI-AUTO mode

1. Press button "Shift", the red LED flashes for indication.
2. Press button "SEMI-AUTO/AUTO" to initiate semi-auto mode. The fixture is manually turned on by pressing the push-switch, and goes off automatically after stand-by time. (Absence detection mode)

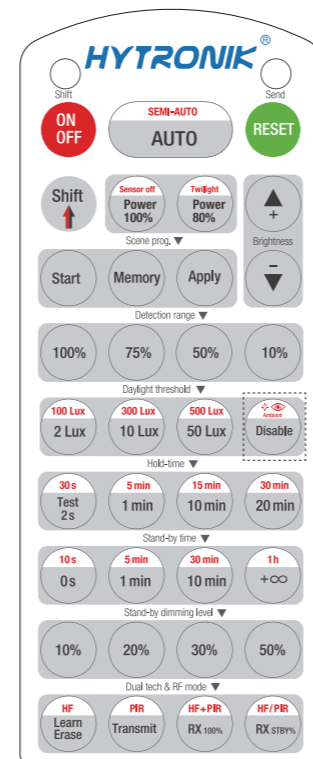

HRC-11