

Product Description

HTG01/F & HTG02/F are Bluetooth modules with a real-time chip built in that can keep real time running for up to 12 weeks during power loss, which is very convenient for Bluetooth system/network where there is constant need for power on/off. When a product group mesh network is created, the entire network takes HTG01/F or HTG02/F as the authoritative time. External Bluetooth antenna can be connected for a longer Bluetooth broadcast distance.

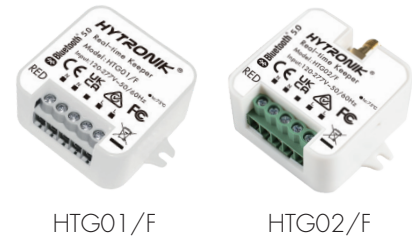

App Features

- Compatible with EnOcean BLE switches
- Grouping luminaires via mesh network
- Device firmware update over-the-air (OTA)
- Continuous development in progress...

Hardware Features

- Two optional reinforced antenna available
- Bluetooth range extender
- Ability to keep real-time for up to 12 weeks during power loss
- Compact design with two screw holes to be built inside luminaires
- Short-circuit protection
- 5-year warranty

Typical Switch Box Mounting

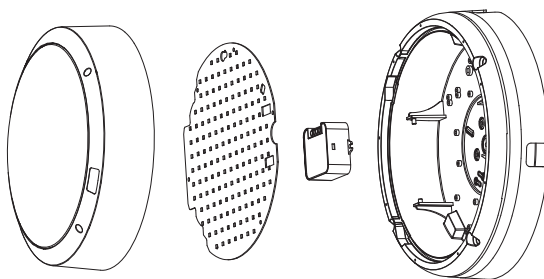

Bluetooth 5.0 SIG mesh

Smartphone app for both iOS & Android platform

Koolmesh Pro app for iPad

Web app/platform: www.iot.koolmesh.com

Optional accessory: Reinforced Bluetooth antenna



HTG01/F

- ※ Standard version
- ※ Keep up to 12 weeks time during power loss
- ※ Repeater / Bluetooth range extender
- ※ Up to 30m transmission distance
- ※ 2 screw holes for mounting



HTG02/F

- ※ Reinforced version
- ※ Keep up to 12 weeks time during power loss
- ※ Repeater / Bluetooth range extender
- ※ 2 screw holes for mounting



Antenna option 1

※ Up to 50m transmission distance



Antenna option 2

※ Up to 50m transmission distance

Technical Specifications

Bluetooth Transceiver	
Operation frequency	2.4 GHz - 2.483 GHz
Transmission power	4 dBm
Range (Typical indoor)	10~30m
Protocol	Bluetooth® 5.0 SIG Mesh

Safety & EMC	
EMC standard (EMC)	EN 55015, EN61547, EN 61000-3-2/3-3
Safety standard (LVD)	EN61347-1, EN 61347-2-11
RED	EN 300328, EN 301489-1/-17

Input & Output Characteristics	
Operating voltage	120~277VAC 50/60Hz

Environment	
Operation temperature	Ta: -20°C ~ +60°C
Storage temperature	-40°C ~ 70°C
Relative humidity	10 ~ 90%
IP rating	IP20
Insulation	Class II

Mechanical Structure & Dimensions

HTG01/F

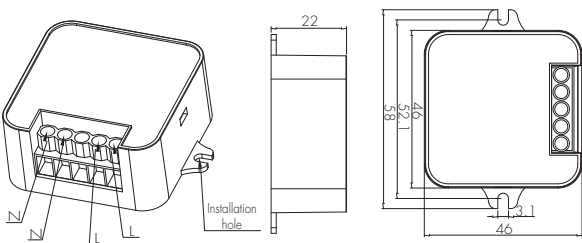

HTG02/F

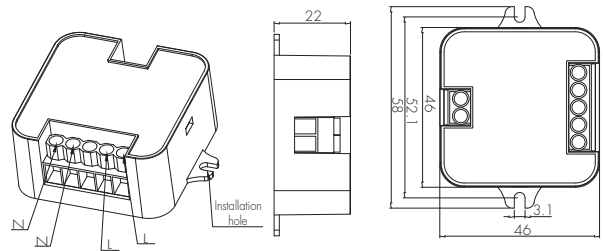

Wire Preparation



To make or release the wire from the terminal, use a screwdriver to push down the button.

Wiring Diagram

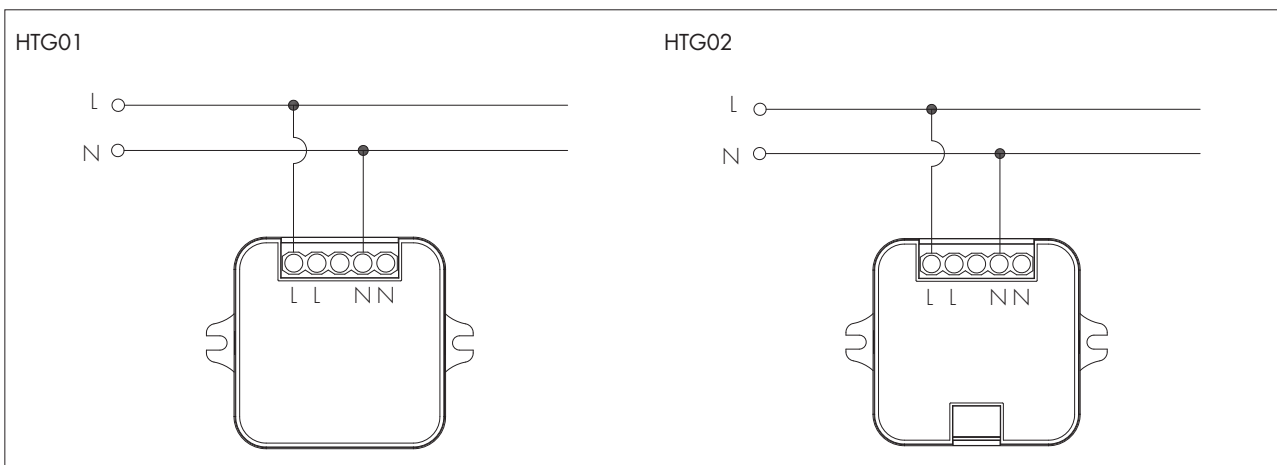

Optional accessory: Reinforced Bluetooth antenna

For some special Applications, customers may need a larger Bluetooth transmission for both smartphone to device and device to device. Thanks to the reinforced Bluetooth antenna (optional 1 or optional 2 to choose from), with it being added to the HTG01/F or HTG02/F, the transmission distance (smartphone to device) enlarges to 20m, the distance of device to device is around 50m.



Option 1

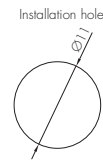
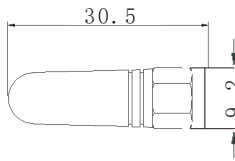

Option 2

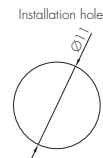
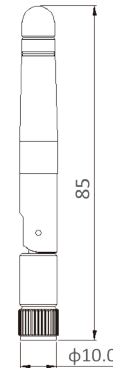
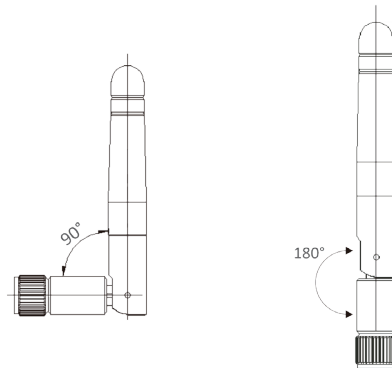

Additional Information / Documents

1. To learn more about detailed product features/functions, please refer to [www.hytronik.com/download->knowledge->Introduction of App Scenes and Product Functions](http://www.hytronik.com/download->knowledge->Introduction%20of%20App%20Scenes%20and%20Product%20Functions)
2. Regarding precautions for Bluetooth product installation and operation, please kindly refer to [www.hytronik.com/download->knowledge->Bluetooth Products - Precautions for Product Installation and Operation](http://www.hytronik.com/download->knowledge->Bluetooth%20Products%20-%20Precautions%20for%20Product%20Installation%20and%20Operation)
3. Regarding Hytronik standard guarantee policy, please refer to [www.hytronik.com/download->knowledge->Hytronik Standard Guarantee Policy](http://www.hytronik.com/download->knowledge->Hytronik%20Standard%20Guarantee%20Policy)