

Product Description

HMW28DCVFC/PRO is Microwave standalone motion sensor integrated with Hytronik True presence detection technology, On/Off control with one relay channel output, which is NO (normally open contact). The Hytronik True presence detection technology works to detect human breathing rather than the mirror movements. No matter if the person sit/stand statically or turns their back to the sensor. The sensor can accurately recognize presence and keeps the lights on all the time. It is ideal for typical indoor applications such as classroom, office, healthcare, and other commercial areas.



Features



Store settings in the remote for easy commissioning when programming multiple sensors



Intelligent photodiode - lights and sensors only operate when needed, natural light has priority



Max withstandable in-rush current: 120A@160μs



VFC: Volt-free Contact/Dry Contact ON/OFF relay switch

– 24VDC@5A

– 250VAC@5A



Black & White & Gray metal surface mount box option



User-friendly design for installation



5 Year warranty

Technical Data

Input Characteristics

Input voltage	12~48 DC
Stand-by power	30mA
Max withstandable in-rush current	120A@160μs
VFC: Volt-free Contact /Dry Contact	– 24VDC@5A – 250VAC@5A

Safety and EMC

EMC standard (EMC)	EN61547, EN55015, EN61000-3/2/-3-3
Safety standard (LVD)	EN60669-1, EN60669-2-1
RED	EN300400, EN301489-1/-3/-17 EN50663, EN30328
Certification	UKCA, CE, RCM

Sensor Data

Sensor Model	Presence Motion detection
Detection range (Max.)*	Installation Height : 3m Detection Range(Ø) : 10m
Detection angle	360°

* For more details of detection range, please refer to "detection pattern" section.

Environment

Operation temperature	Ta: -20°C ~ +50°C
Storage temperature	-40°C ~ +70°C
IP rating	IP20
Relative humidity	10 ~ 90%

Mechanical Structure

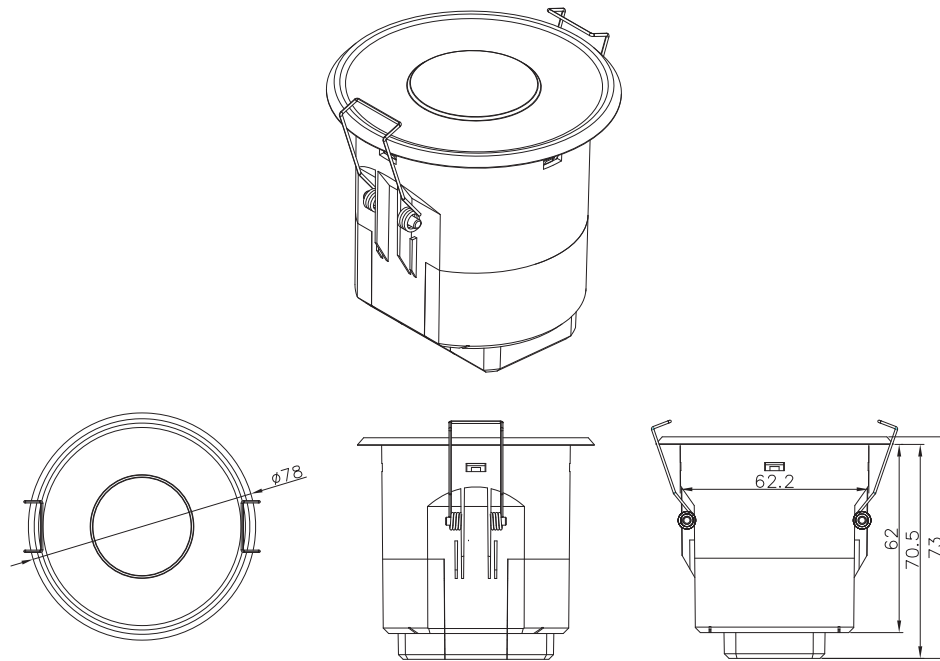

Note:

1. We recommend the mounting distance between sensor to sensor should be more than 2m to prevent sensors from false-triggering.
 2. The face-to-face installation between sensors and sensors or other radio sources is not recommended, or false trigger issue will potentially behave. Make sure the installed environment is free of any obvious vibration, strong air blows, curtain swing, water flow in pipe
- The recommended mounting distance between sensor to sensor is >3m to prevent sensors from false-triggering and furtherly adjust per actual environment.

Wiring Diagram

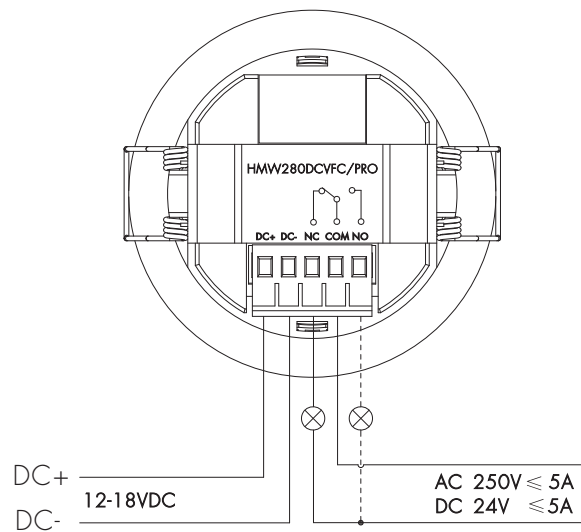

Wire Preparation

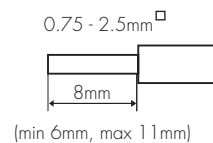

Pluggable screw terminal. It is recommended to make connections to the terminal before fitting to the sensor.

Detection Pattern

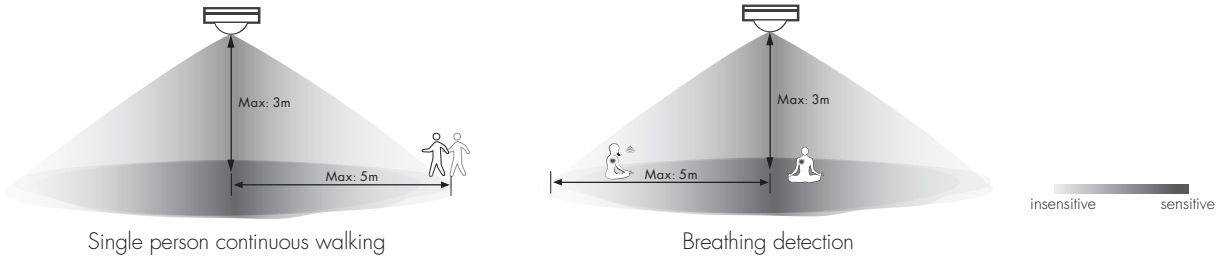

Single person continuous walking

Breathing detection

When it's in breathing & true presence detection mode and in sitting situation, facing to sensor directly will have a better detection range than 90 degrees side facing to sensor.

Optional Accessory --- Ceiling/Surface Metal Mount Box: HA09/W, HA09/B, HA09/G

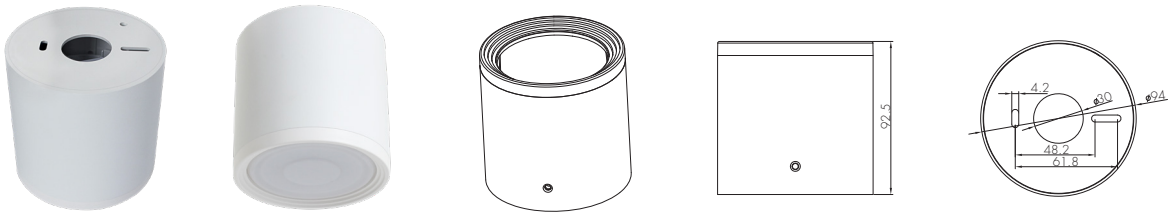

Big and small silicon gasket used to make IP54 degree protection when mounted into HA09 housing for ceiling mount

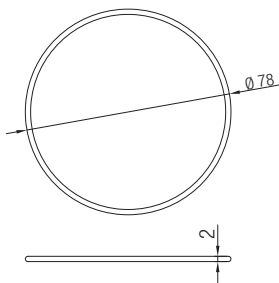

Small silicon water-proof gasket dimension(size:mm)

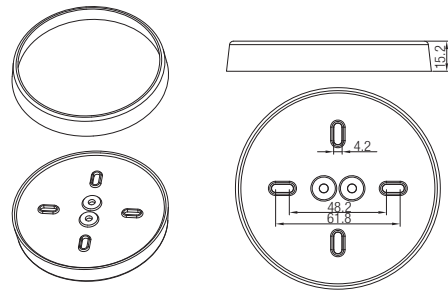

Big silicon water-proof gasket dimension(size:mm)

Optional Accessory --- HA08

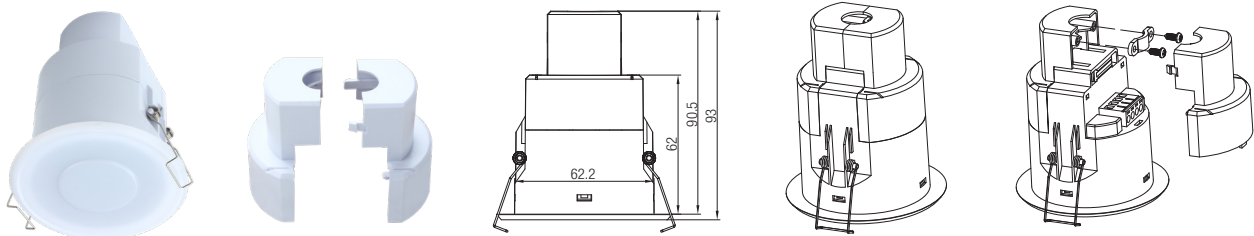

*Note: Optional Accessory HA09 & HA08 can not be used together.

1 On/ off Control

This sensor is a motion switch, which turns on the light upon detection of motion or breathing, and turns off after a pre-selected hold-time when there is no movement or breathing. A daylight sensor is also built in to prevent the light from switching on when there is sufficient natural light.

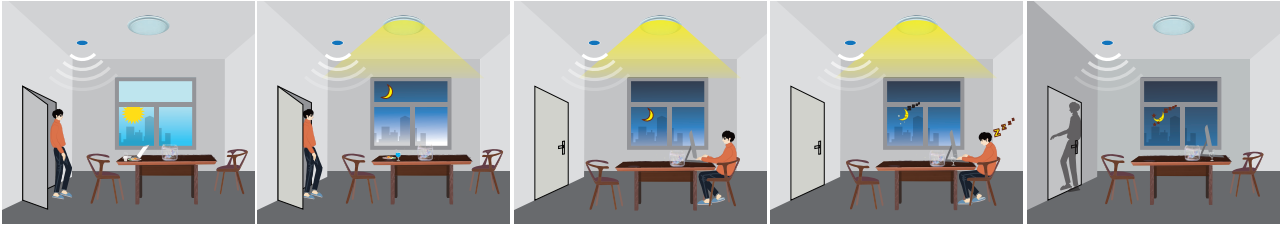

2 Lux Off Function

The built-in photodiode will also automatically turn off the light when the ambient natural light exceeds the programmed lux level for more than 5min, regardless of whether motion is detected or not.

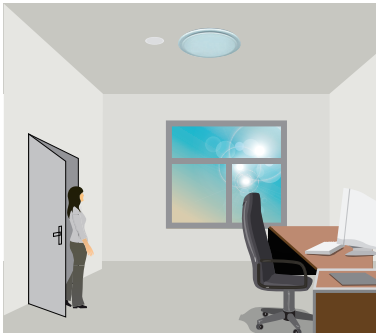

With sufficient natural light, the light does not switch on when presence is detected.

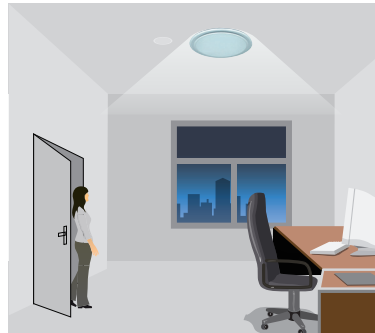

With insufficient natural light, the sensor switches on the light automatically when presence is detected.

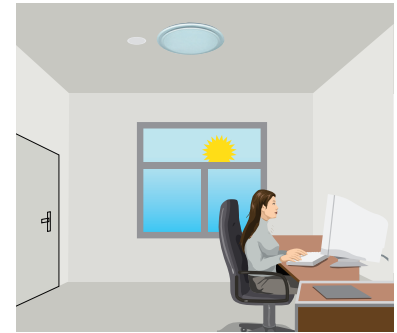

The sensor switches off the light when natural light is sufficient, even with presence.

Settings (Remote Control HRC-12)

ON / OFF

Permanent ON/OFF function

Press button "ON/OFF" to select permanent ON or permanent OFF mode.

* Press button "AUTO", "RESET" or "Ambient" to quit this mode.

The mode will change to AUTO Mode after power failure.

RESET

Reset Settings

Press button "RESET", all settings go back to default values as below:

Detection range: 100%; Hold-time: 5min; Lux disabled

AUTO

Sensor mode

Press "Auto Mode" button, the sensor starts to function and all settings remain the same as the latest status before the light is switched on/off.

SEMI
AUTO

SEMI-AUTO mode

This key is not applicable on this product.



HRC-12

Detection range

Press buttons in zone "HF sensor Detection range" to set detection range at 100% / 75% / 50% / 10%.

Daylight threshold

Press buttons in zone "Daylight threshold" to set daylight sensor at 2Lux / 10Lux / 50Lux / 100Lux / 300Lux / 500Lux / Disable.

Ambient daylight threshold

Press button "Ambient", the surrounding lux level is sampled and set as the new daylight threshold.

Hold-time

Press buttons in zone "hold-time" to set the hold-time at 5sec / 1min / 5min / 10min / 15min / 30min / 60min.

Note: 1. 5sec is test mode.

2. Press button 30min / 60min, the actual setting is 25min.

Additional Information / Documents

1. Regarding precautions for PIR sensor installation and operation, please kindly refer to [www.hytronik.com/download ->knowledge ->Microwave Sensors - Precautions for Product Installation and Operation](http://www.hytronik.com/download->knowledge->Microwave+Sensors+Precautions+for+Product+Installation+and+Operation)
2. Regarding Hytronik standard guarantee policy, please refer to [www.hytronik.com/download ->knowledge ->Hytronik Standard Guarantee Policy](http://www.hytronik.com/download->knowledge->Hytronik+Standard+Guarantee+Policy)