

## Flush Mount Presence Motion Sensor

### HMW28VFC/PRO

On/off control & Low-bay

# HYTRONIK®



### Product Description

HMW28VFC/PRO is Microwave standalone motion sensor integrated with Hytronik True presence detection technology, On/Off control with one relay channel output, which is NO (normally open contact). The Hytronik True presence detection technology works to detect human breathing rather than the mirror movements. No matter if the person sit/stand statically or turns their back to the sensor. The sensor can accurately recognize presence and keeps the lights on all the time. It is ideal for typical indoor applications such as classroom, office, healthcare, and other commercial areas.



### Features



Store settings in the remote for easy commissioning when programming multiple sensors



Intelligent photodiode - lights and sensors only operate when needed, natural light has priority



Max withstandable in-rush current: 120A@160µs



VFC: Volt-free Contact/Dry Contact ON/OFF relay switch

– 24VDC@5A

– 250VAC@5A



NO contact



Black & White & Gray metal surface mount box option



User-friendly design for installation



5 Year warranty

### Technical Data

#### Input Characteristics

Mains voltage	220~240VAC 50/60Hz
Stand-by power	<0.3W
Max withstandable in-rush current	120A@160µs
VFC: Volt-free Contact /Dry Contact	– 24VDC@5A – 250VAC@5A

#### Sensor Data

Sensor Model	Presence Motion detection
Detection range (Max.)*	Installation Height : 3m Detection Range(Ø) : 1.0m
Detection angle	360°

\* For more details of detection range, please refer to "detection pattern" section.

#### Safety and EMC

EMC standard (EMC)	EN61547, EN55015, EN61000-3/2/-3-3
Safety standard (LVD)	EN60669-1, EN60669-2-1
RED	EN300400, EN301489-1/-3/-17 EN50663, EN30328
Certification	UKCA, CE, RCM

#### Environment

Operation temperature	Ta: -20°C ~ +50°C
Storage temperature	-40°C ~ +70°C
IP rating	IP20
Relative humidity	10 ~ 90%

## Mechanical Structure

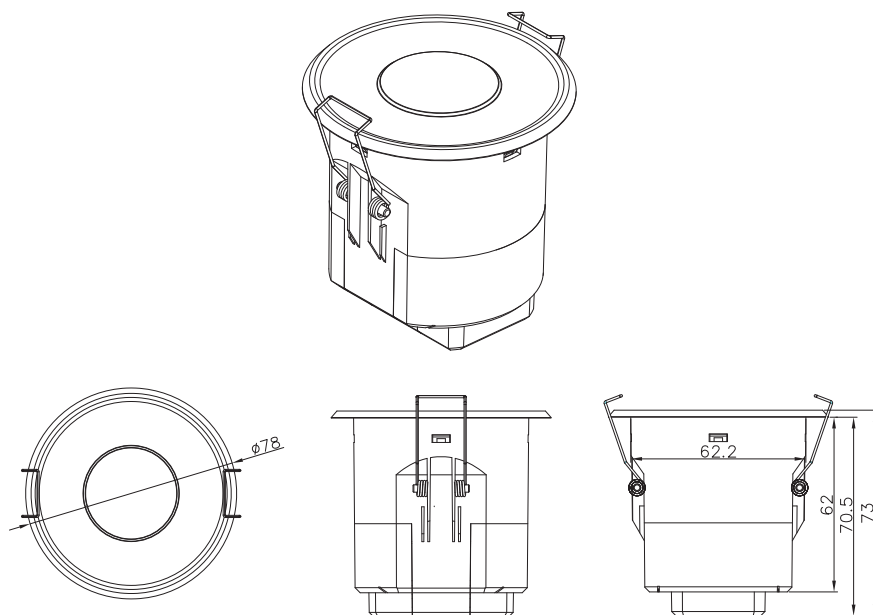

Note:

1. We recommend the mounting distance between sensor to sensor should be more than 2m to prevent sensors from false-triggering.
  2. The face-to-face installation between sensors and sensors or other radio sources is not recommended, or false trigger issue will potentially behave. Make sure the installed environment is free of any obvious vibration, strong air blows, curtain swing, water flow in pipe .....
- The recommended mounting distance between sensor to sensor is >3m to prevent sensors from false-triggering and furtherly adjust per actual environment.

## Wiring Diagram

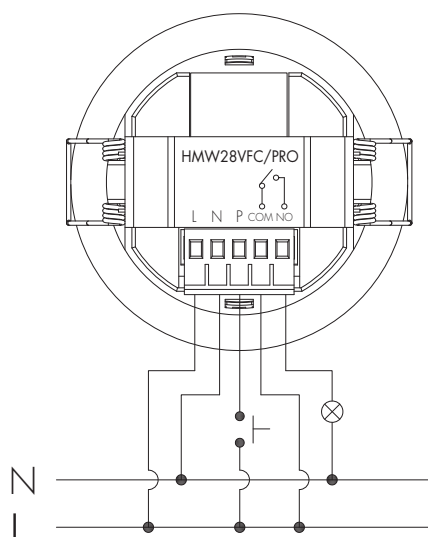

## Wire Preparation

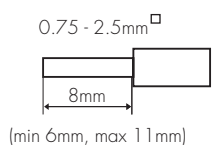
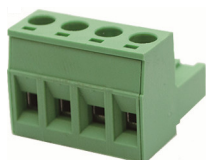

Pluggable screw terminal. It is recommended to make connections to the terminal before fitting to the sensor.

## Detection Pattern

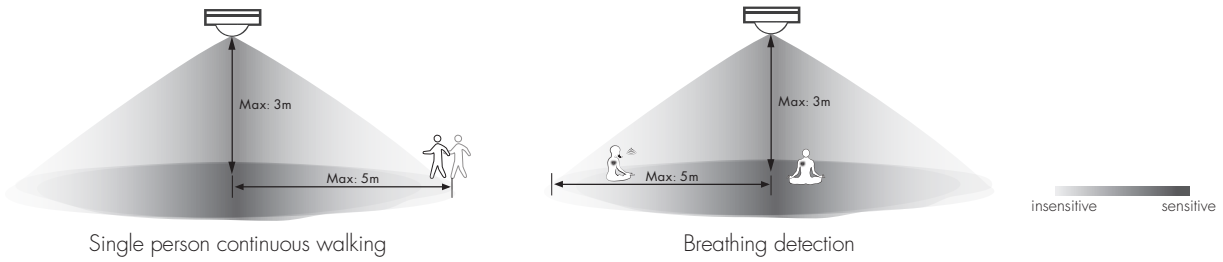

Single person continuous walking

Breathing detection

When it's in breathing & true presence detection mode and in sitting situation, facing to sensor directly will have a better detection range than 90 degrees side facing to sensor.

## Optional Accessory --- Ceiling/Surface Metal Mount Box: HA09/W, HA09/B, HA09/G

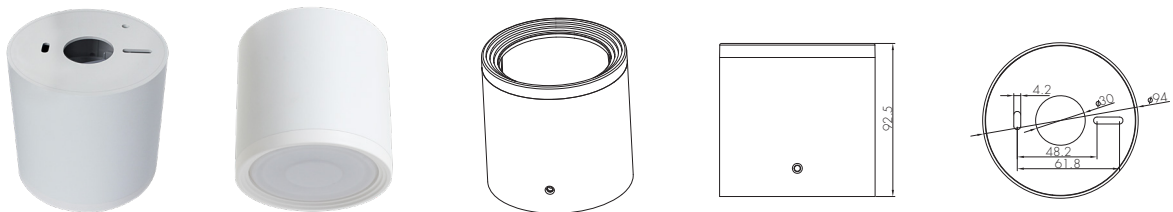

## Big and small silicon gasket used to make IP54 degree protection when mounted into HA09 housing for ceiling mount

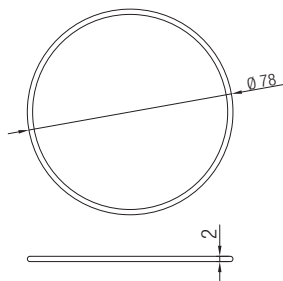

Small silicon water-proof gasket dimension(size:mm)

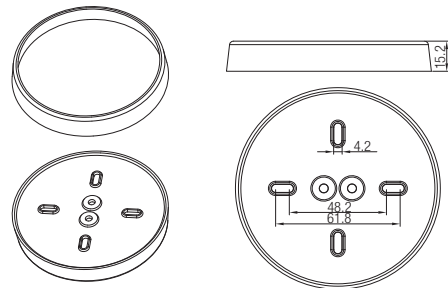

Big silicon water-proof gasket dimension(size:mm)

## Optional Accessory --- HA08

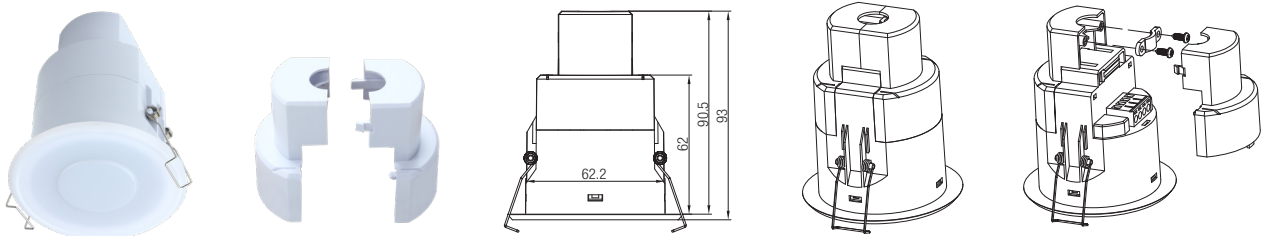

\*Note: Optional Accessory HA09 & HA08 can not be used together.

### 1 On/ off Control

This sensor is a motion switch, which turns on the light upon detection of motion or breathing, and turns off after a pre-selected hold-time when there is no movement or breathing. A daylight sensor is also built in to prevent the light from switching on when there is sufficient natural light.

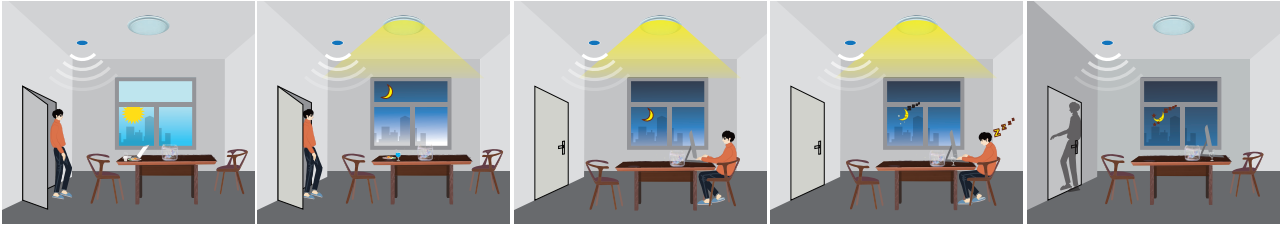

### 2 Lux Off Function

The built-in photodiode will also automatically turn off the light when the ambient natural light exceeds the programmed lux level for more than 5min, regardless of whether motion is detected or not.

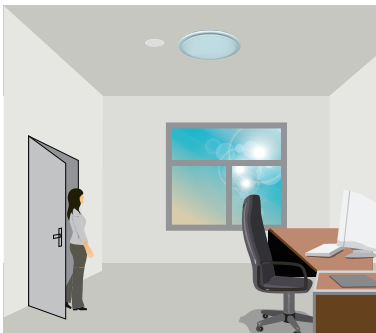

With sufficient natural light, the light does not switch on when presence is detected.

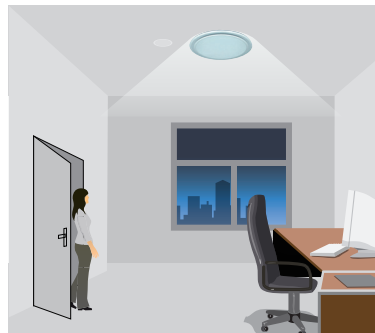

With insufficient natural light, the sensor switches on the light automatically when presence is detected.

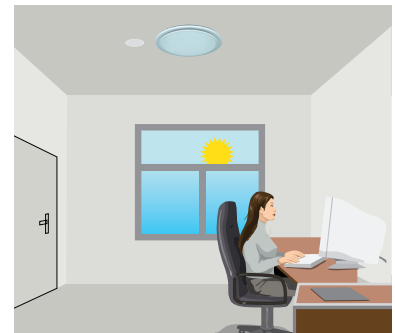

The sensor switches off the light when natural light is sufficient, even with presence.

### 3 Manual Override

With the help of push-switch, this sensor can be over-riden by the end-user to manually switch on/off the light, which makes the product more user-friendly and offers more options to fit some extra-ordinary demands:

\* Short Push (<1s): on/off function;

On → Off: the light turns off immediately and cannot be triggered ON by motion until the expiration of pre-set hold-time. After this period, the sensor goes back to normal sensor mode.

Off → On: the light turns on and goes to sensor mode, no matter if ambient Lux level exceeds the daylight threshold or not.

*Note: if end-user do not want this manual override function, just leave the "push" terminal unconnected to any wire.*

### 4 Semi-auto Mode (Absence Detection)

It is easy to forget to switch off the light, in office, corridor, even at home. And in many other cases, people do not want to have a sensor to switch on the light automatically, for example, when people just quickly pass-by, there is no need to have the light on. The solution is to apply this "absence detector": motion sensor is employed, but only activated on the manual press of the push-switch, the light keeps being ON in the presence, and switches off in the long absence.

*Note: end-user can choose either function 3 or function 4 for application. Default function is manual override.*

## Settings (Remote Control HRC-12)

ON / OFF

### Permanent ON/OFF function

Press button "ON/OFF" to select permanent ON or permanent OFF mode.

\* Press button "AUTO", "RESET" or "Ambient" to quit this mode.

The mode will change to AUTO Mode after power failure.

RESET

### Reset Settings

Press button "RESET", all settings go back to default values as below:

Detection range: 100%; Hold-time: 5min; Lux disabled

AUTO

### Sensor mode

Press "Auto Mode" button, the sensor starts to function and all settings remain the same as the latest status before the light is switched on/off.

SEMI  
AUTO

### SEMI-AUTO mode

Press "SEMI-AUTO" button, to enter semi-auto mode. The fixture is manually on by push-switch and automatically off in this mode.

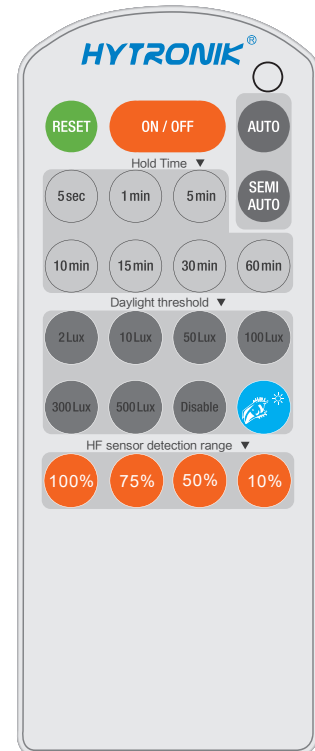

HRC-12

### Detection range

Press buttons in zone "HF sensor Detection range" to set detection range at 100% / 75% / 50% / 10%.

### Daylight threshold

Press buttons in zone "Daylight threshold" to set daylight sensor at 2Lux/ 10Lux / 50Lux / 100Lux / 300Lux / 500Lux / Disable.

### Ambient daylight threshold

Press button "Ambient", the surrounding lux level is sampled and set as the new daylight threshold.

### Hold-time

Press buttons in zone "hold-time" to set the hold-time at 5sec / 1min / 5min / 10min / 15min / 30min / 60min.

Note: 1. 5sec is test mode.

2. Press button 30min / 60min, the actual setting is 25min.

## Additional Information / Documents

1. Regarding precautions for HF sensor installation and operation, please kindly refer to [www.hytronik.com/download ->knowledge ->Microwave Sensors - Precautions for Product Installation and Operation](http://www.hytronik.com/download->knowledge->Microwave+Sensors+Precautions+for+Product+Installation+and+Operation)
2. Regarding Hytronik standard guarantee policy, please refer to [www.hytronik.com/download ->knowledge ->Hytronik Standard Guarantee Policy](http://www.hytronik.com/download->knowledge->Hytronik+Standard+Guarantee+Policy)