

## On/off Control Sensor

### HC038

Detached Linear Version with Remote Control

# HYTRONIK®

## Applications







Occupancy detector with on/off control suitable for indoor use:

- Office / Commercial Lighting
- Classroom
- Meeting Room

Use for new luminaire designs and installations



## Features

-  Special photocell to measure and differentiate natural light from LED light
-  Lux off function, daylight threshold prior to motion detection
-  On/off control based upon occupancy
-  One-touch daylight learning via remote control
-  Zero crossing detection circuit reduces in-rush current and prolongs relay life
-  Loop-in and loop-out terminal for efficient installation
-  5-year warranty

## Technical Data

### Input Characteristics

Model No.	HC038
Mains voltage	220~240VAC 50/60Hz
Stand-by power	<0.5W
Load ratings:	
HC038	400VA (capacitive) 800W (resistive)
Warming-up	20s

### Safety and EMC

EMC standard (EMC)	EN55015, EN61000
Safety standard (LVD)	EN60669, AS/NZS60669
Radio Equipment (RED)	EN300440, EN301489, EN62479
Certification	Semko, CB, CE, EMC, LVD, RCM

CE emc RED   CB IP20

### Sensor Data

Model No.	HIRO2/RC12 SAM13	HIRO4/RC12 SAM13/RC12
Sensor principle:		
HIRO2/RC12 HIRO4/RC12	PIR Detection	
SAM13 SAM13/RC12	High Frequency (microwave)	
Detection range:		
HIRO2/RC12 HIRO4/RC12	Max. (Ø x H) 6m x 3m	
SAM13 SAM13/RC12	Max. (Ø x H) 12m x 6m	
Detection angle	30° ~ 150°	

### Environment

Operation temperature	Ta: -20°C ~ +55°C
Case temperature (Max.)	Tc: +80°C
IP rating	IP20

Sensor Main Body  
HC038

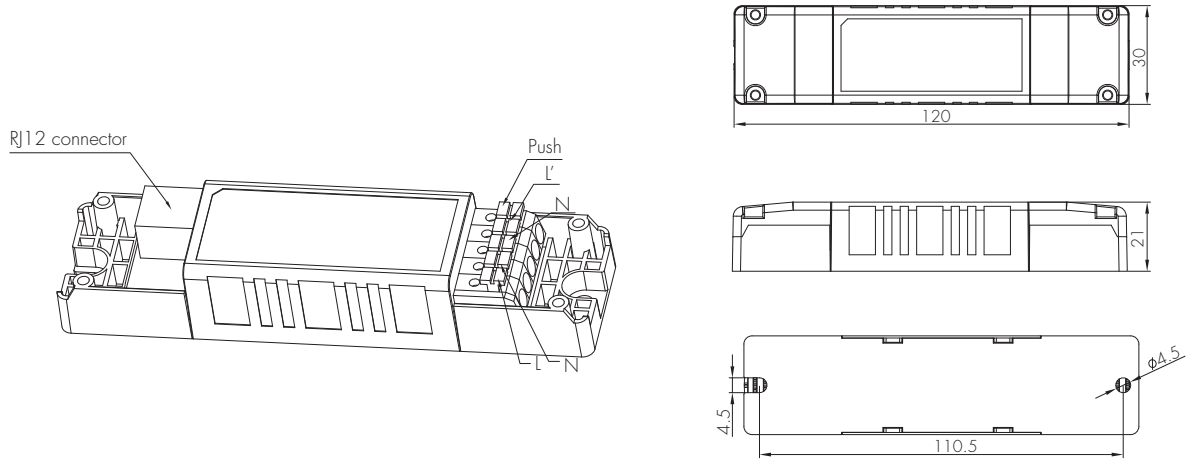

There are two different sensor antenna modules to choose from:

<p>PIR Sensor Head Model HIR02/RC12</p>			
<p>PIR Sensor Head Model HIR04/RC12</p>			
<p>HF Sensor Head Model SAM13</p>			
<p>HF Sensor Head Model SAM13/RC12</p>			

#### 4 sensor antennas and 1 control units offer 4 combinations in total:

- A PIR antenna HIRO2/RC12+ On/off control HC038
- B PIR antenna HIRO4/RC12+ On/off control HC038
- C microwave antenna SAM13+ On/off control HC038
- D microwave antenna SAM13/RC12+ On/off control HC038



Note: We recommend the mounting distance between sensor to sensor should be more than 2m to prevent sensors from false-triggering.

## Functions and Features

### 1 On/off Control

This sensor is a motion switch, which turns on the light upon detection of motion, and turns off after a pre-selected hold-time when there is no movement. A daylight sensor is also built in to prevent the light from switching on when there is sufficient natural light.

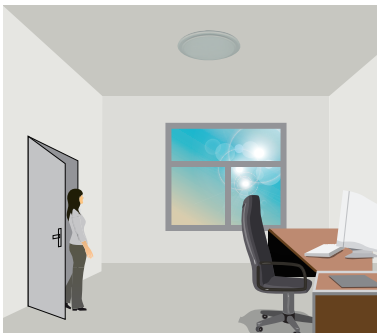

With sufficient natural light, the light does not switch on when presence is detected.

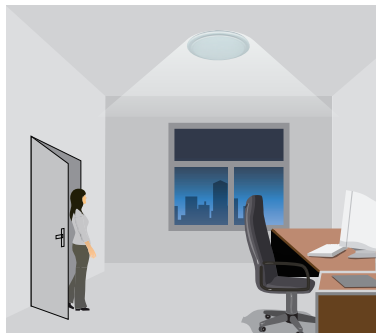

With insufficient natural light, the sensor switches on the light automatically when presence is detected.



The sensor switches off the light automatically after the hold-time when there is no motion detected.

### 2 Photocell Advance™ Function (HIRO4/RC12)

It's well known that LED lights have a totally different spectrum to natural light. Hytronik uses this principle and comes up with special photocell and sophisticated software algorithm to measure and differentiate natural light from LED light, so that this photocell can ignore the LED light and only respond to the natural light. Our technology has no infringement to the existing patents in the market.

### 3 Lux Off Function (HIRO2/RC12 & HIRO4/RC12)

The light turns off automatically whenever surrounding natural light lux level exceeds the daylight threshold for more than 5min, even there is motion detected.

### 4 Manual Override

This sensor reserves the access of manual override function for end-user to switch on/off, which makes the product more user-friendly and offers more options to fit some extra-ordinary demands:

\* Short Push (< 1s): on/off function;

On → Off: the light turns off immediately and cannot be triggered ON by motion until the expiration of pre-set hold-time. After this period, the sensor goes back to normal sensor mode.

Off → On: the light turns on and goes to sensor mode, no matter if ambient Lux level exceeds the daylight threshold or not.

Note: if end-user do not want this manual override function, just leave the "push" terminal unconnected to any wire.

## 5 Semi-auto Mode (Absence Detection)

It is easy to forget to switch off the light, in office, corridor, even at home. And in many other cases, people do not want to have a sensor to switch on the light automatically, for example, when people just quickly pass-by, there is no need to have the light on. The solution is to apply this "absence detector": motion sensor is employed, but only activated on the manual press of the push switch, the light keeps being ON in the presence, and switches off in the long absence.

This is a good combination of sensor automation and manual override control, to have the maximum energy saving, and at the same time, to keep efficient and comfortable lighting.



The light does not switch on when there is presence being detected.



Short push to activate the sensor and switch on the light

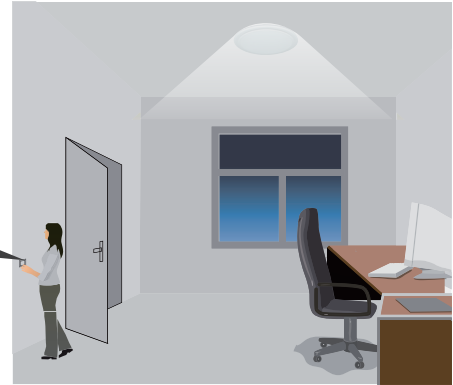

The light turns on full, and the sensor stays in sensor mode.

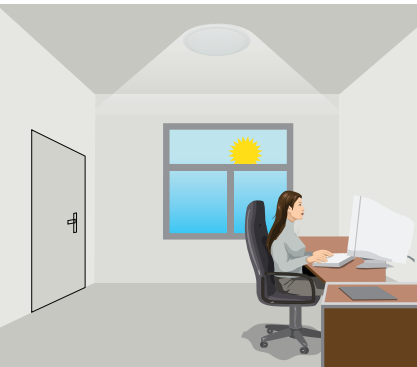

The light keeps being ON during the presence.

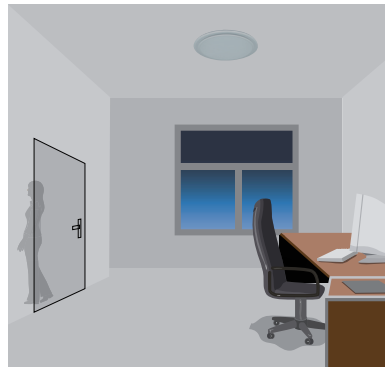

People left, the light switches off automatically.

*Note: end-user can choose either function 4 or function 5 for application. Default function is manual override.*

## 6 Zero-cross Relay Operation (HC038)

Designed in the software, sensor switches on/off the load right at the zero-cross point, to ensure that the in-rush current is minimised, enabling the maximum lifetime of the relay.

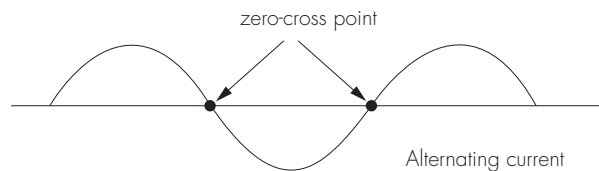

**7 Loop-in and Loop-out Terminal (HC038)**

Double L N terminal makes it easy for wire loop-in and loop-out, and saves the cost of terminal block and assembly time.

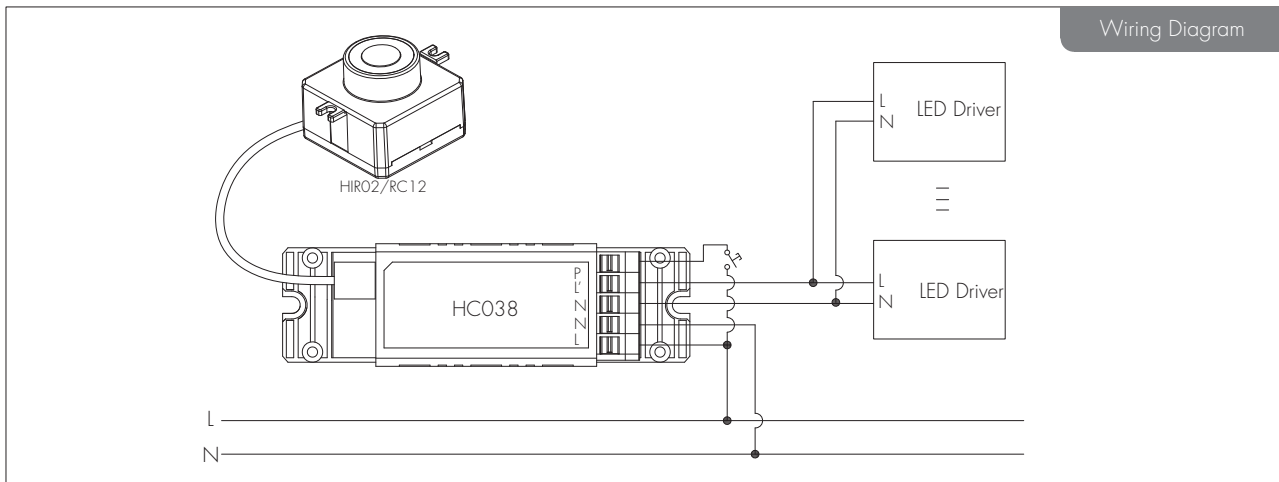

**Detection Pattern (Ceiling mounted)**

Model HIRO2/RC12 & HIRO4/RC12

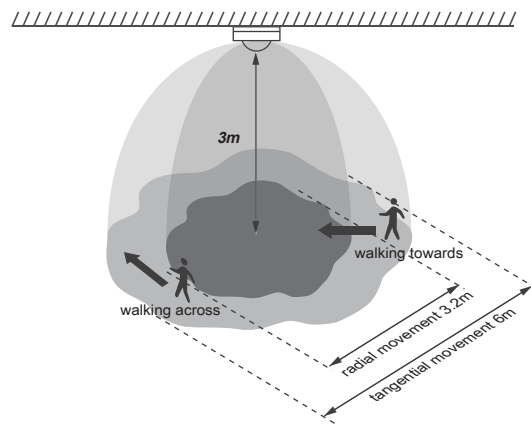

Model SAM13 & SAM13/RC12

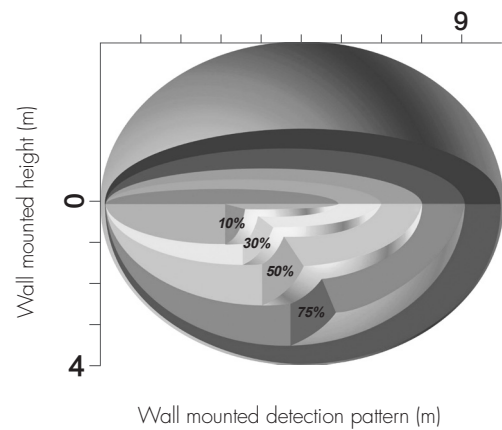
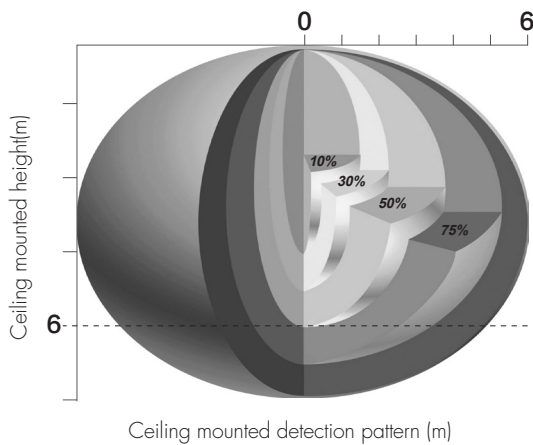

## DIP Switch Settings (For SAM13)

### 1 Detection Area

Sensor sensitivity can be adjusted by selecting the combination on the DIP switches to fit precisely for each specific application.

	1	2	
I	●	●	100%
II	●	○	75%
III	○	●	50%
IV	○	○	10%



I – 100%  
II – 75%  
III – 50%  
IV – 10%

### 2 Hold Time

Select the DIP switch configuration for the light on-time after presence detection. This function is disabled when natural light is sufficient.

	3	4	5	
I	●	●	●	5s
II	●	○	●	30s
III	●	○	○	1min
IV	○	●	●	5min
V	○	●	○	10min
VI	○	○	●	20min
VII	○	○	○	30min



I – 5s  
II – 30s  
III – 1min  
IV – 5min  
V – 10min  
VI – 20min  
VII – 30min

### 3 Daylight Sensor

Set the level according to the fixture and environment. The light will not turn on if ambient lux level exceeds the daylight threshold preset.

*Please note that the ambient lux level refers to internal light reaching the sensor.*

Disabling the daylight sensor will put the sensor into occupancy detection only mode.

	6	7	
I	●	●	Disable
II	●	○	50Lux
III	○	●	10Lux
IV	○	○	2Lux



I – Disable  
II – 50Lux  
III – 10Lux  
IV – 2Lux

## Settings (Remote Control HRC-12, for HIR02/RC12 & HIR04/RC12 & SAM13/RC12)

ON / OFF

Permanent ON/OFF function

Press button "ON/OFF" to select permanent ON or permanent OFF mode.

\* Press button "AUTO", "RESET" or "Ambient" to quit this mode.

The mode will change to AUTO Mode after power failure.

RESET

Reset Settings

Press button "RESET", all settings go back to default values.

AUTO

Sensor mode

Press "Auto Mode" button, the sensor starts to function and all settings remain the same as the latest status before the light is switched on/off.

SEMI  
AUTO

SEMI-AUTO mode

Press button "SEMI-AUTO" to initiate semi-auto mode. The fixture is manually turned on by pressing the push-switch, and goes off automatically after hold time. (Absence detection mode)

### Daylight threshold

Press buttons in zone "Daylight threshold" to set daylight sensor at 2Lux / 10Lux / 50Lux / 100Lux / 300Lux / 500Lux / Disable.

### Ambient daylight threshold

Press button "Ambient", the surrounding lux level is sampled and set as the new daylight threshold.

### Hold-time

Press buttons in zone "hold-time" to set the hold-time at 5sec / 1min / 5min / 10min / 15min / 30min / 60min.

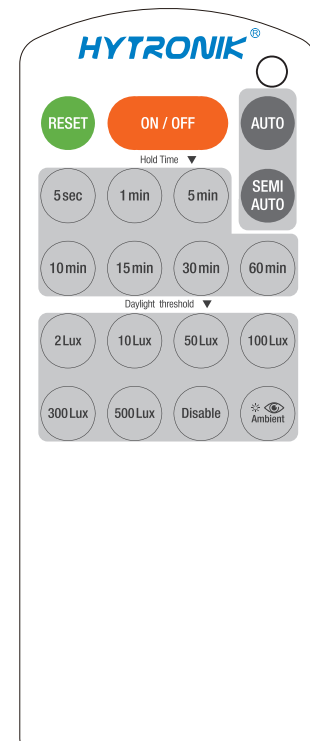

HRC-12

## Additional Information / Documents

1. For full explanation of Hytronik Photocell Advance™ technology, please kindly refer to [www.hytronik.com/download](http://www.hytronik.com/download) ->knowledge ->Introduction of Photocell Advance
2. Regarding precautions for microwave sensor installation and operation, please kindly refer to [www.hytronik.com/download](http://www.hytronik.com/download) ->knowledge ->Microwave Sensors - Precautions for Product Installation and Operation
3. Regarding precautions for PIR sensor installation and operation, please kindly refer to [www.hytronik.com/download](http://www.hytronik.com/download) ->knowledge ->PIR Sensors - Precautions for Product Installation and Operation
4. Data sheet is subject to change without notice. Please always refer to the most recent release on [www.hytronik.com/products/Motion Sensors](http://www.hytronik.com/products/Motion%20Sensors) ->Built-in HF Sensor
5. Regarding Hytronik standard guarantee policy, please refer to [www.hytronik.com/download](http://www.hytronik.com/download) ->knowledge ->Hytronik Standard Guarantee Policy