

IP65 HF Zhaga book 18 Standard Motion Sensor with Bluetooth® 5.0 SIG Mesh

SAM15/BLE
High-Bay



Product Description

SAM15/BLE is a Bluetooth high-bay HF motion sensor and compatible with the Zhaga book 18 standard. It is designed with a robust IP65 structure and the capability can be up to 15m installation height, which is ideal for the typical outdoor lamp (such as a streetlight). SAM15/BLE is embedded with a Bluetooth module to achieve dimming control and colour tuning. The Bluetooth wireless mesh networking makes communication much easier without any hardwiring, which eventually adds value to luminaires and saves costs for projects. Meanwhile, simple device setup and commissioning can be done via **Koolmesh™** app.



TYPE D

App Features

- Quick setup mode & advanced setup mode
- Tri-level control
- Daylight harvest
- Circadian rhythm (Human centric lighting)
- Floorplan feature to simplify project planning
- Web app/platform for dedicated project management
- Koolmesh Pro iPad version for on-site configuration
- Grouping luminaires via mesh network
- Scenes
- Detailed motion sensor settings
- Dusk/Dawn photocell (Twilight function)
- Push switch configuration
- Schedule to run scenes based on time and date
- Astro timer (sunrise and sunset)
- Staircase function (primary & secondary)
- Internet-of-Things (IoT) featured
- Device firmware update over-the-air (OTA)
- Device social relations check
- Bulk commissioning (copy and paste settings)
- Dynamic daylight harvest auto-adaptation
- Power-on status (memory against power loss)
- Offline commissioning
- Different permission levels via authority management
- Network sharing via QR code or keycode
- Remote control via gateway support HBGW01
- Interoperability with Hytronik Bluetooth product portfolio
- Compatible with EnOcean BLE switches
- Continuous development in progress...



Hardware Features

- Zhaga Book 18 standard
- IP65 design
- Robust HF antenna design wireless interference
- High-bay (up to 15m height)
- 5-year warranty

Bluetooth 5.0 SIG mesh

   
for iOS for Android

Smartphone app for both iOS & Android platform

 
for iPad

Koolmesh Pro app for iPad

  
for Web

Web app/platform: www.iot.koolmesh.com

Technical Specifications

Bluetooth Transceiver	
Operation frequency	2.4 GHz - 2.483 GHz
Transmission power	4 dBm
Range (Typical indoor)	10~30m
Protocol	 Bluetooth® 5.0 SIG Mesh

Input & Output Characteristics	
Stand-by power	<0.5W
Operating voltage¤t	12-36V @ 30mA
Bus current consumption	2mA

Environment	
Operation temperature	Ta: -20°C ~ +50°C
Storage temperature	-40°C ~ +70°C
Relative humidity	10 ~ 90%
IP rating	IP65
Insulation	Class II

Sensor Data	
Sensor principle	High Frequency (microwave)
Detection range*	Max installation height: 1.5m (forklift)
	1.2m (single person)
	Max detection range: 1.6m (diameter)
Detection angle	360°

* The detection range is heavily influenced by sensor placement (angle) and different walking paces. It may be reduced under certain conditions.

Safety & EMC	
EMC standard (EMC)	EN61547
Safety standard (LVD)	EN61347-1 EN61347-2-11
Certification	CE , UKCA
RED	EN300440, EN300328, EN301489-1/-3/-17 EN50663
Compliance	RoHs, Reach
DALI standard	IEC62386-101/103, Part 351
D4i	Single master, Type D

Mechanical Structure & Dimensions

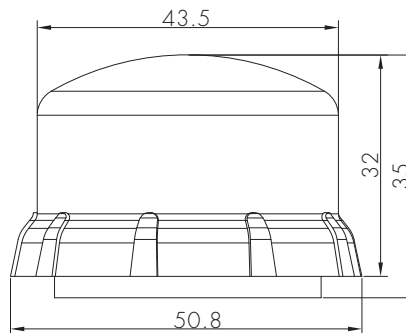
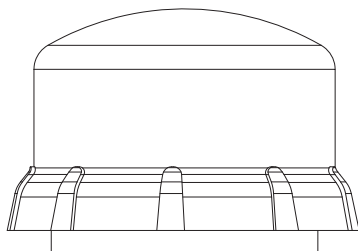
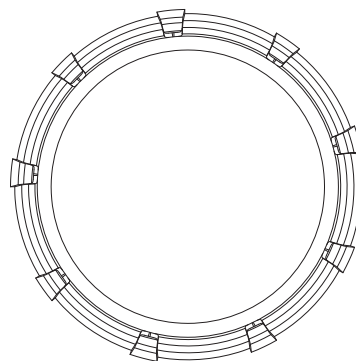
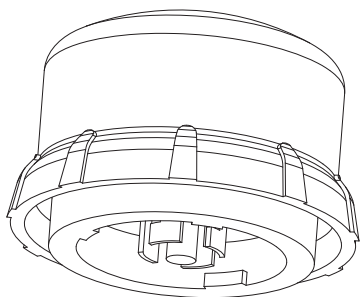

Wiring Diagram 1

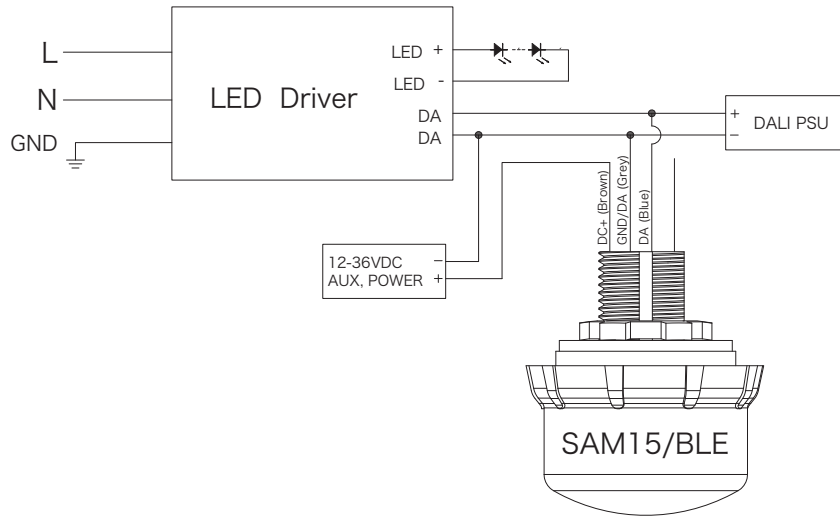

Wiring Diagram 2

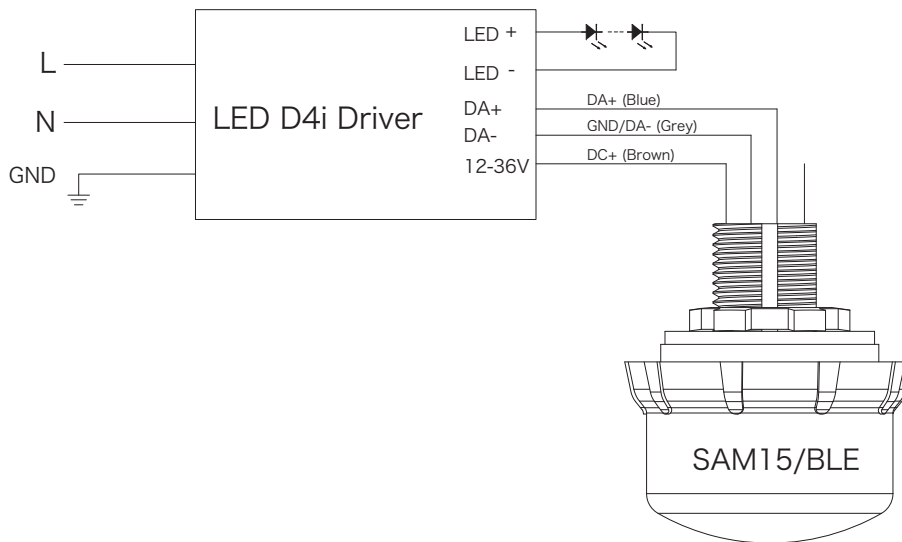

Wiring Diagram 3

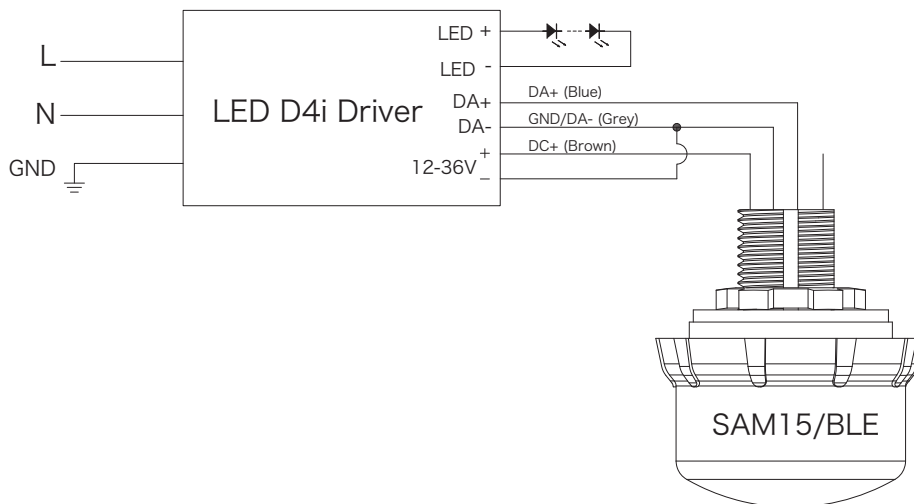

Detection Range

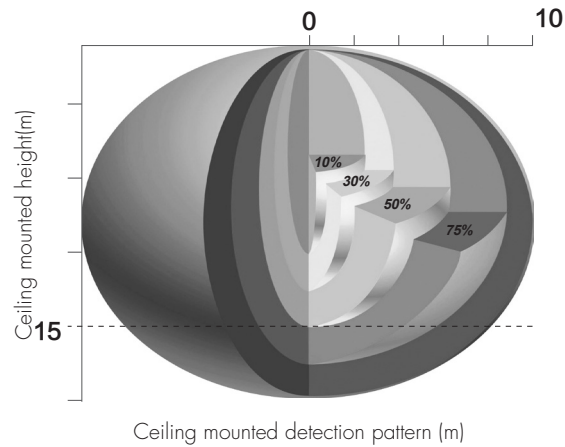

Height (m)	Sensitivity			
	100%	75%	50%	30%
	Diameter (Ø:m)			
12	14	10	8	4
8	16	14	10	6
5	20	16	10	8
3	22	18	14	10

Placement Guide and Typical Range

Smart Phone to Device Range

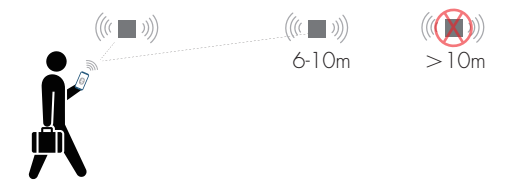

The smart device with the App installed will have a typical range of 10m, but varies from device to device. During commissioning, the installer will need to be in range of the devices when searching for devices to add to the network.

Once the devices have been added to the network via the App, the devices will start communicating within the wireless mesh. This means that once the network is complete, all devices are accessible from the smart device when in a 20m range of a single point.



Hytronik's microwave motion sensor uses 5.8GHz high frequency (HF) antenna in the product design. With the increasing density of wireless environments such as 5G GSM tower and 5G Wi-Fi coverage, this has created extra challenges for sensor's operation because the air is shared by all kinds of wireless signals, and transmissions from any device at the similar frequency could potentially cause interference. The effects of interference which can be noticed by users are usually false triggering of sensors (turning on/off erratically), or lights staying on even after hold time etc.

To get around such tough environment, Hytronik has developed a new series of robust HF modules, designed to be loaded with our own special sophisticated software algorithms. These robust HF modules can withstand different types of wireless interferences in the real application. We believe this is the ultimate solution towards demanding installation environments in the future.

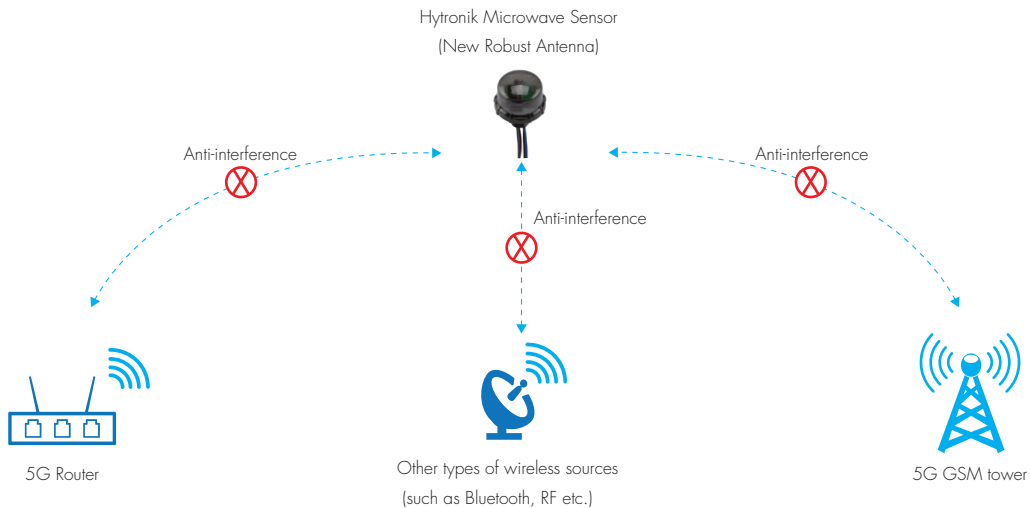

Additional Information / Documents

1. To learn more about detailed product features/functions, please refer to [www.hytronik.com/download ->knowledge ->Introduction of App Scenes and Product Functions](http://www.hytronik.com/download->knowledge->Introduction of App Scenes and Product Functions)
2. Regarding precautions for Bluetooth product installation and operation, please kindly refer to [www.hytronik.com/download ->knowledge ->Bluetooth Products - Precautions for Product Installation and Operation](http://www.hytronik.com/download->knowledge->Bluetooth Products - Precautions for Product Installation and Operation)
3. Regarding precautions for microwave sensor installation and operation, please kindly refer to [www.hytronik.com/download ->knowledge ->Microwave Sensors - Precautions for Product Installation and Operation](http://www.hytronik.com/download->knowledge->Microwave Sensors - Precautions for Product Installation and Operation)
4. Data sheet is subject to change without notice. Please always refer to the most recent release on www.hytronik.com/products/bluetooth technology ->Bluetooth Sensors
5. Regarding Hytronik standard guarantee policy, please refer to [www.hytronik.com/download->knowledge ->Hytronik Standard Guarantee Policy](http://www.hytronik.com/download->knowledge->Hytronik Standard Guarantee Policy)