

FLUSH MOUNT PIR MOTION SENSOR

HIR32

Two DALI Channels Output

1. Technical Specifications

Mains voltage	220-240VAC 50/60Hz
Stand-by power	<0.5W
DALI Channel 1	Max. 25pcs devices, 50mA
DALI Channel 2	Max. 15pcs devices, 30mA
Warming-up	Appr. 20s
Sensor principle	PIR detection
Detection range (Max.)*	Installation Height : 6m Detection Range (Ø) : 9m
Detection angle	360°
Operation temperature	Ta: -20°C ~ +50°C
IP rating	IP20
EMC standard (EMC)	EN55015, EN61000
Safety standard (LVD)	EN60669, AS/NES60669
Certification	CB, CE, EMC, RoHS

2. Installation

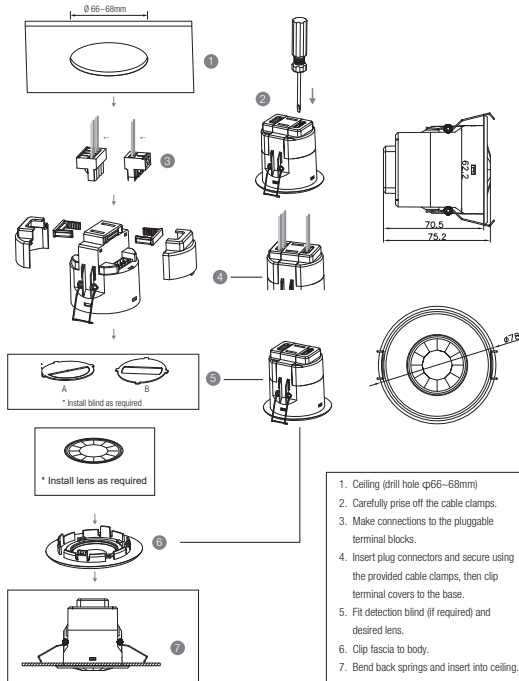

3. Functions

3.1 Daylight Harvest (Daylight Regulating)

Daylight sensor measures the available surrounding natural light, calculates how much electrical light is needed to reach the total lux expected. The demand is given to the LED driver by DALI signal, so as to deliver the needed amount of electric light.

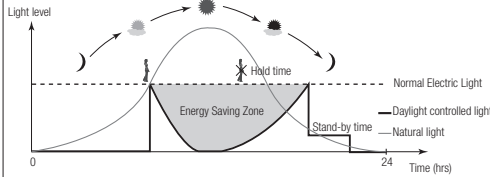

3.2 Lux Off Function

The built-in daylight sensor can measure ambient natural light and switch off the fixture automatically whenever artificial light is not required (natural light lux level exceeds daylight threshold).

3.3 Dual DALI Output Control

Two channels of self-powered DALI output are available on HIR32 for connection of two groups of LED drivers. Please note that both channels share the same control settings sent from the occupancy sensor and photocell.

System Capacity	DALI channel	DALI Driver < 2mA
HIR32 includes 2 channels total 80mA max. DALI PSU	DALI PSU Channel 1 (max 50mA)	25 pcs
	DALI PSU Channel 2 (max 30mA)	15 pcs

3.4 Manual Override (Push Function)

Three push terminals (P1, P2, P3) are available on the HIR32 for end-users to switch on/off, change the light brightness, colour temperature of the two DALI channels temporarily. The settings will revert to daylight harvest mode after sensor time-out.

- * Long push on P1: adjust the hold-time light brightness of DALI channel 1; Short push (<1s) on P1: on/off function
- * Long push on P2: adjust the hold-time light brightness of DALI channel 2; Short push (<1s) on P2: on/off function
- * Long push on P3: cycles through colour tuning on both channels. (work with DT8 LED driver only) Short push (<1s) on P3: resume automatic daylight harvest mode.

Wire Preparation



Pluggable screw terminal. It is recommended to make connections to the terminal before fitting to the sensor.

- 200 metres (total) max. for 1mm² CSA (Ta = 50°C)
- 300 metres (total) max. for 1.5mm² CSA (Ta = 50°C)

4. Wiring Diagram

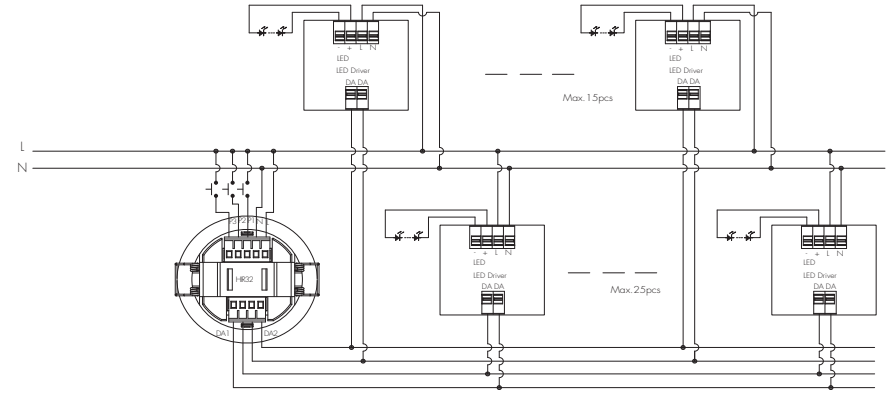

5. Description of the Button Functions (remote control HRC-11)

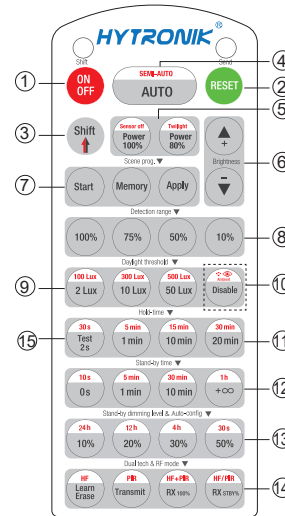

Permanent ON/OFF [button ①]

Press button ①, to select permanent ON or permanent OFF mode.
* Press button ②/④ to quit this mode.

RESET [button ②]

Press button ②, all settings go back to default values as below:
Hold-time 5min, Daylight sensor 100Lux, Stand-by time: 10min, Stand-by dimming level: 20%

Test Mode [button ③]

This button is for testing purpose only. The sensor goes to test mode (hold-time is 2s) after commissioning, meanwhile the stand-by period and daylight sensor are disabled.
* This mode can be ended by pressing "reset", or any button of "scene mode" and "hold-time". The sensor settings are changed accordingly.

Shift [button ③]

Press button ③, the LED on the top left corner is on to indicate mode selection. All values / settings in RED are in valid for 20 seconds.

Auto Mode [button ④]

Press button ④ to initiate automatic mode. The sensor starts working and all settings remain as before the light is switched ON/OFF.

Semi-auto Mode [button ④ & ⑤]

1. Press button ④ Shift (the red LED is on for indication).
2. Press button ⑤ to initiate semi-auto mode. The fixture is manually on by push-switch and automatically off in semi-auto mode.

Power output [button ⑥]

Press button ⑥, the light output shifts between 80% and 100%.
Note: the function of "Sensor off" and "Twilight" are disabled.

Brightness +/- [button ⑥]

Press button ⑥ to adjust the light brightness and color temperature between 10%~100%.

Scene prog. [zone ⑦] (One-key-commissioning)

- Press button "Start" to program.
- Select the buttons in ⑦ "Detection range", ⑧ "Daylight threshold", ⑨ "Hold time", ⑩ "Stand-by time", ⑪ "Stand-by dimming level" to set all parameters.
- Press button ⑫ "Memory" to save all the settings programmed in the remote control.

- Press button ⑬ "Apply" to set the settings to each sensor unit(s).
For example, to set detection range 100%, daylight threshold Disable, hold time 5min, stand-by time +∞, stand-by dimming level 30%, steps should be:
Press button ⑬ Start, button ⑬ 100%, ⑬ Disable, ⑬ Shift, ⑬ 5min, ⑬ Shift, ⑬ +∞, ⑬ 30%, ⑬ Memory. By pointing to the sensor unit(s) and pressing ⑬ Apply, all settings are passed on the sensor(s).

Detection range [zone ⑧]

These two buttons are disabled.

Daylight threshold [zone ⑧]

Press buttons in zone ⑧ to set daylight sensor at 2Lux / 10Lux / 50Lux / 100Lux / 300Lux / 500Lux / Disable.
Note: To set daylight sensor at 100Lux / 300Lux / 500Lux, press ⑩ Shift button first.

Ambient daylight threshold [button ⑩]

- Press button ⑩ Shift, the red LED starts to flash.
- Press button ⑩, the ambient lux level is sampled and set as the new daylight threshold / target Lux level.

Hold time [zone ⑨]

Press buttons in zone ⑨ to set the hold time at 2s / 30s / 1min / 5min / 10min / 15min / 20min / 30min.
Note: 1. To set hold-time at 30s / 5min / 15min / 30min, press button ⑩ Shift at first.

2. 2s is for test purpose only, stand-by period and daylight sensor settings are disabled in this mode.

*To exit from Test mode, press button ② or any button in zone ④.

Stand-by time [zone ⑨]

Press buttons in zone ⑨ to set the stand-by period at 0s / 10s / 1min / 5min / 10min / 30min / 1h / +∞.
Note: "0s" means on/off control; "+∞" means bi-level control, 100% on when motion detected, and remains at the stand-by dimming level when no presence after hold-time.

Stand-by dimming level [zone ⑩]

Press buttons in zone ⑩ to set the stand-by dimming level at 10% / 20% / 30% / 50%.
Note: the function of 24h/12h/4h/30s are disabled.

Dual tech & RF mode [zone ⑩]

All buttons in zone ⑩ are disabled.

6. Detection Pattern & Optional Accessories



HIR32 (Low-bay)

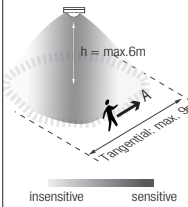
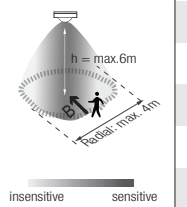

HIR32: Low-bay flat lens detection pattern for **single person** @ Ta = 20°C
 (Recommended ceiling mount installation height **2.5m-6m**)

A: Tangential movement	B: Radial movement	Mount height	Tangential (A)	Radial (B)
		2.5m	max 50m ² (Ø = 8m)	max 13m ² (Ø = 4m)
		3m	max 64m ² (Ø = 9m)	max 13m ² (Ø = 4m)
		4m	max 38m ² (Ø = 7m)	max 13m ² (Ø = 4m)
		5m	max 38m ² (Ø = 7m)	max 13m ² (Ø = 4m)
		6m	max 38m ² (Ø = 7m)	max 13m ² (Ø = 4m)

Optional Accessory --- Ceiling/Surface Metal Mount Box: HA09/W, HA09/B, HA09/G

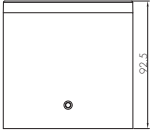
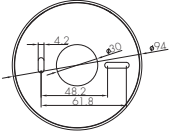
Optional Accessory --- Blind Insert for Blocking Certain Detection Angles



Blind Option 1 --- Aisle Detection



Blind Option 2 --- 180° Detection

7. Additional Information / Documents

1. Regarding precautions for PIR sensor installation and operation, please kindly refer to www.hytronik.com/download ->knowledge ->PIR Sensors - Precautions for Product Installation and Operation
2. Regarding Hytronik standard guarantee policy, please refer to www.hytronik.com/download ->knowledge ->Hytronik Standard Guarantee Policy