

IP65 DALI-2 PIR Zhaga book 18 Standard Motion Sensor

HIR15 (High-Bay)
DALI-2 output



Product Description

HIR15 is a Zhaga book 18 standard PIR motion sensor with DALI-2 output (40mA DALI-2 power supply built-in), which enables lighting designers/manufacturers to freely connect to luminaires. All sensor parameters can be programmed through remote controller HRC-11, like adjusting sensitivity, time, lux level, and brightness settings. Designed with a sturdy IP65 structure, HIR15 is perfect for high-bay applications, accommodating installations of up to 12m in height, making it ideal for outdoor lighting like streetlights.



TYPE D

Hardware Features

- 50mA DALI-2 Broadcast output
- Zhaga Book 18 standard
- Photocell Advance™
- IP65 design
- High-bay (up to 12m height)
- Remote controllable
- 5-year warranty

Technical Specifications

Input & Output Characteristics	
Operating voltage	24VDC
Stand-by power	max<0.5
Output	I guaranteed: 30mA I max: 50 mA U rated: 15VDC
Lux range	0-1000Lux
Sensitivity	10% / 30% / 50% / 75% / 100%

Environment	
Operation temperature	Ta: -20°C ~ +50°C
Storage temperature	-30°C ~ +70°C
Relative humidity	20~90%
IP rating	IP65
Insulation	Class II

Sensor Data	
Sensor principle	PIR
Detection range*	Max installation height: 12m Max diameter: 20m
Detection angle	360°

* The detection range is heavily influenced by sensor placement (angle) and different walking paces. It may be reduced under certain conditions.

Safety & EMC	
EMC standard (EMC)	EN55015, EN61547
Safety standard (LVD)	EN61347-1, EN61347-2-11
Certification	CE, UKCA
Compliance	RoHS Reach
DALI-2	IEC62386-101,103,351

Mechanical Structure & Dimensions

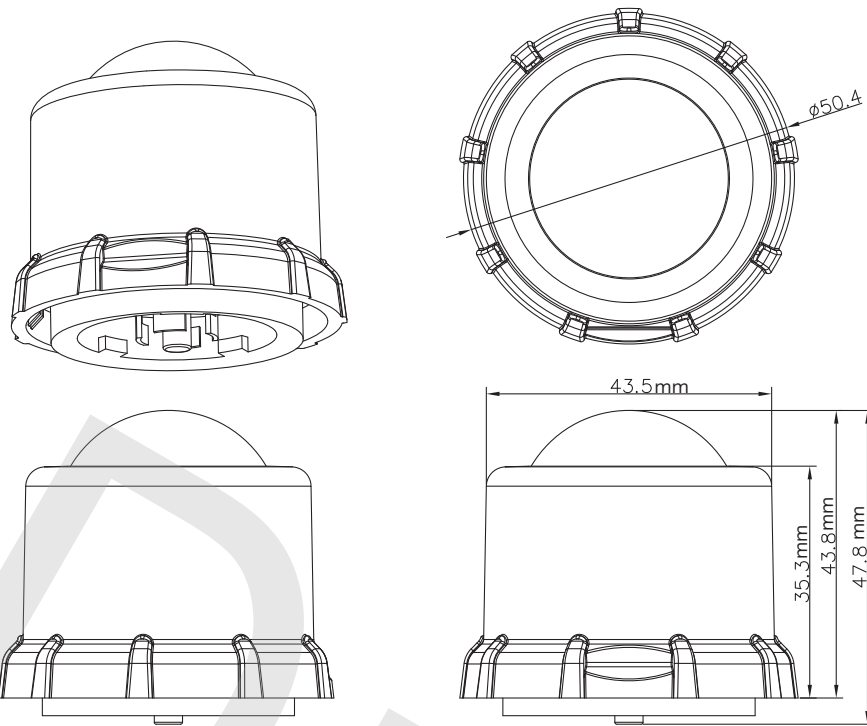

Wiring Diagram 1

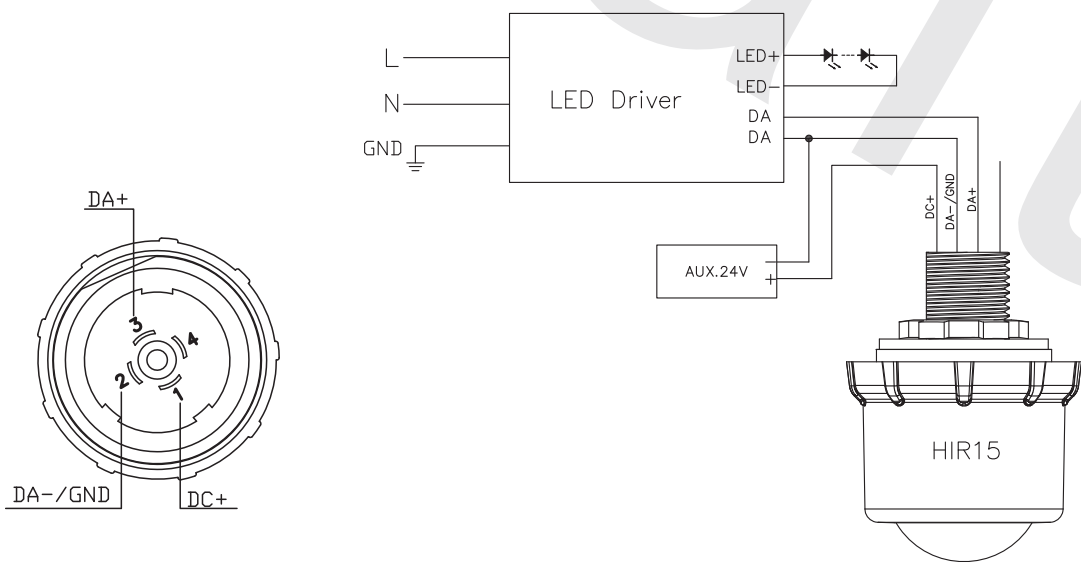

Wiring Diagram 2

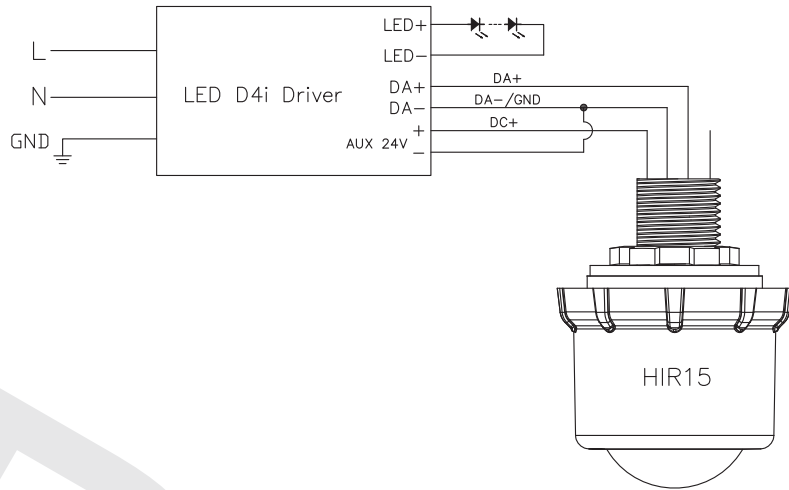

Wiring Diagram 3

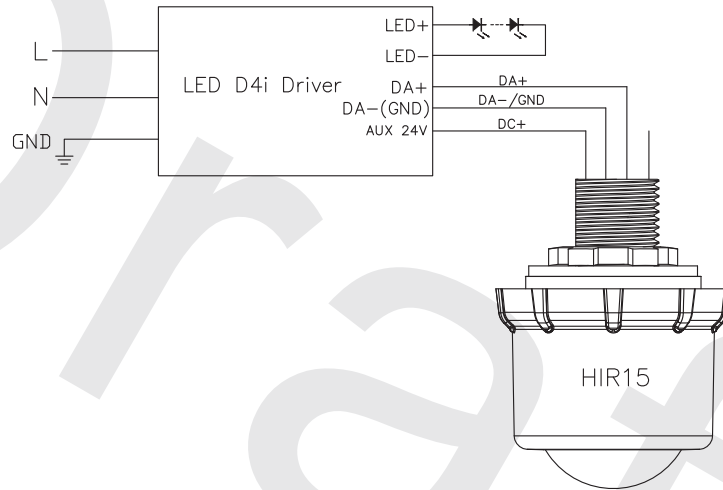

Detection Range

The data below is tested under following conditions:

- Single person walking;
- Sensor not connected to any driver that may have soft-on period;
- The testing is conducted in an open and spacious indoor field, without noticeable obstacles or influences that may affect PIR performances.

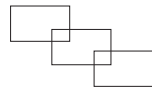

A: Tangential movement	B: Radial movement	Mount height	Tangential Movement (A)	Radial Movement (B)
		3m	max 50m ² (Ø = 8m)	max 13m ² (Ø = 4m)
		5m	max 79m ² (Ø = 10m)	max 13m ² (Ø = 4m)
		8m	max 154m ² (Ø = 14m)	max 13m ² (Ø = 4m)
		12m	max 314m ² (Ø = 20m)	max 13m ² (Ø = 4m)

Settings (Remote Control HRC-11)

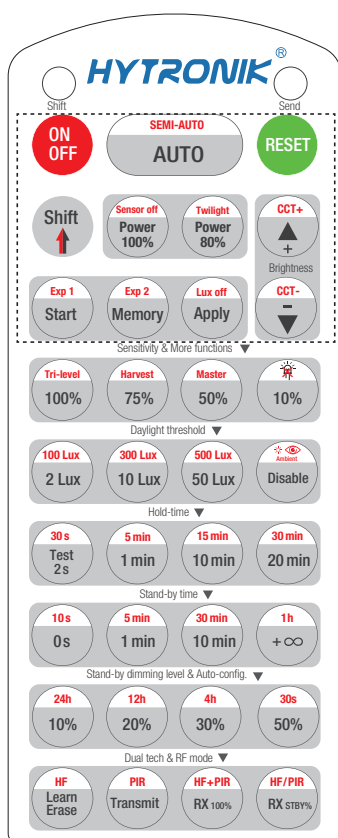

HRC-11

ON OFF	Press button "ON/OFF" to enter the ON/OFF mode or SENSOR OFF mode to control the light. Press button "AUTO" / "RESET" / "Sensor OFF" / "Twilight" or restart to exit this mode.
RESET	Press button "RESET", perform the latest DIP Switch/Rotary Switch settings. The default settings are: Auto mode; Detection range 100%; Daylight sensor disable; Stand-by time 10min; Stand-by dimming level 20%; Maximum Brightness & white Color; LED indication off; Lux off activated; PIR detection mode.
Shift	Press button "Shift", the LED on the top left corner is on to indicate mode selection. All values / settings in RED are valid for 20 seconds.
AUTO	Press button "AUTO" to initiate automatic mode. The sensor starts working and all settings remain as before the light is switched ON/OFF;
SEMI-AUTO	This key is not applicable on this product.
Power 100% 80%	Press buttons in zone "Power out" to select the light output at 80% (at initial 10,000 hours) or 100%.
Sensor off Twilight	1. Press button "Shift", the red LED on. 2. Press button "Sensor off", the function of movement detection is disabled, the function of photocell is also disabled. OR Press button "Twilight", the function of movement detection is disabled, but the function of photocell is still working, and the product becomes a pure dusk/ dawn To exit from "Sensor off" / "Twilight" mode, press button "AUTO" / "SEMI-AUTO" / "RESET".
▲ ▼	Press these two buttons to adjust the light output brightness and set a new target lux level. The daylight sensor can measure ambient daylight level and ignore the LED light, so as to calculate how much artificial light is needed to maintain the target lux level.
CCT+ CCT-	1. Press button "Shift", the red LED on. 2. Press "CCT+" or "CCT-" button to adjust colour turning.
Start Memory Apply	1. Press button "Start" to program. 2. Select the buttons in "Detection range", "Daylight threshold", "Hold-time", "Stand-by time", "Stand-by dimming level" to set all parameters. 3. Press button "Memory" to save all the settings programmed in the remote control. 4. Press button "Apply" to set the settings to each sensor unit(s). <i>For example, to set detection range 100%, daylight threshold Disable, hold-time 5min, stand-by time +∞, stand-by dimming level 30%, the steps should be: Press button "Start", button "100%", "Disable", "Shift", "5min", "Shift", "+∞", "30%", "Memory". By pointing to the sensor unit(s) and pressing "Apply", all settings are passed on the sensor(s).</i>
Lux off	The "Lux off" function is activated as default. When the ambient lux level exceeds the target level continuously for more than 5 minutes, the lights will be turned off. In AUTO /SEMI-AUTO/Twilight modes, to disable "Lux off": 1. Press "Shift" button first, the red LED on. 2. Press "Lux off" button, the "Lux Off" function will be deactivated. The lights will not turn off even when the ambient lux level exceeds the target lux level but will dim down the brightness to the stand-by time level. <i>For Sensor LED indicator references: 1. Fast flash 1s, "Lux off" function activated. 2. Remains on 2s, "Lux off" function deactivated.</i>
Exp 1 Exp 2	"Exp" refer to Expansion, these two buttons are reserved functions and pending future development.

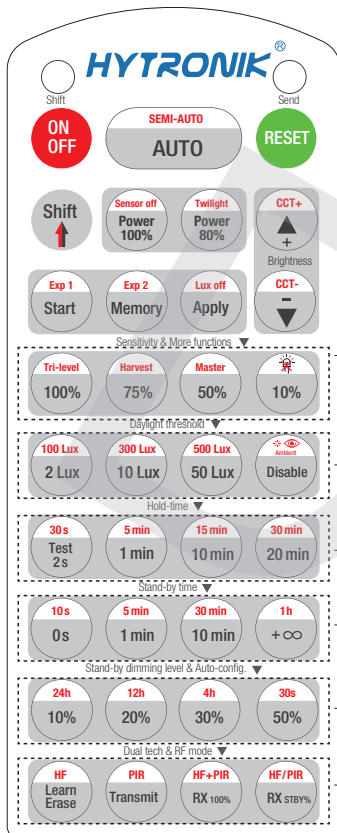

HRC-11

Sensitivity & More functions	
100% 75% 50% 10%	In AUTO /SEMI-AUTO modes, press buttons in zone "Detection range" to set detection range at 100%/75%/50%/10%.
Tri-level Harvest	1.Press button "Shift", the red LED on. 2. Press buttons "Tri-level" or "Daylight harvest" to shift between Tri-level control mode and Daylight harvest mode.
Master	1.Press button "Shift", the red LED on. 2. Press button "Master" to select a DALI sensor in a DALI line to be a "master", so that all other DALI sensors in the same DALI line will perform daylight harvesting/tri-level control based on the lux reading from this "master" sensor's daylight sensor.
Daylight threshold	
2 Lux 100 Lux 10 Lux 300 Lux 50 Lux 500 Lux Disable	Press buttons in zone "Daylight threshold" to set daylight sensor at 2Lux / 10Lux / 50Lux / 100Lux / 300Lux/500Lux / Disable. <i>Note: To set daylight sensor at 100Lux / 300Lux/500Lux , press "Shift" button first.</i>
Ambient	1. Press button "Shift", the red LED on. 2. Press button "Ambient", the surrounding lux level is sampled and set as daylight threshold / target Lux level.
Hold-time mode	
Test 2s 30s 1min 5min 10min 15min 20min 30min	In AUTO /SEMI-AUTO modes, press buttons in zone "hold-time" to set the hold-time at 2s / 30s / 1min / 5min / 10min / 15min / 20min / 30min. <i>Note: 1. To set hold-time at 30s / 5min / 15min / 30min, press "Shift" button first. 2. 2s is for testing purpose only, stand-by period and daylight sensor settings are disabled in this mode. *To exit from Test mode, press button "RESET" or any button in "Hold-time".</i>
Stand-by time mode	
0s 10s 1min 5min 10min 30min +∞ 1h	Press buttons in zone "stand-by time" to set the stand-by period at 0s / 10s / 1min / 5min / 10min / 30min / 1h / +∞. <i>Note: 1. To set stand-by-time at 10s/ 5min / 30min / 1h, press "Shift" button first. 2. "0s" means on/off control; 3. "+∞" means bi-level control, the fixture is 100% on when there is motion detected, and remains at the stand-by dimming level when no presence after motion holdtime. Only when the stand-by time is set in "+∞" and the ambient lux level is below the target lux level, the lux will auto-on.</i>
Stand-by dimming level & Auto-config.	
10% 20% 30% 50%	Press the button in zone "stand-by dimming level" to set the stand-by dimming level at 10% / 20% / 30% / 50%.
24h 12h 4h 30s	1.Press button "Shift", the red LED on. 2.Select a time period and the sensor will do light level measurement and determine/save the lowest light level (commission line) with 100% light on, so as to set the target lux level automatically. <i>Note:1.Make sure the light level measurement covers the night time. 2.The fixture will go into sensor mode after the measurement, all sensor setting remain unchanged.</i>
Dual tech & RF mode	
Learn Erase Transmit	This key is not applicable on this product.
RX 100% RX STBY%	This key is not applicable on this product.
HF PIR HF+PIR HF/PIR	This key is not applicable on this product.

Additional Information / Documents

1. Regarding precautions for PIR sensor installation and operation, please kindly refer to www.hytronik.com/download→knowledge→PIR Sensors - Precautions for Product Installation and Operation
2. Regarding Hytronik standard guarantee policy, please refer to www.hytronik.com/download→knowledge→Hytronik Standard Guarantee Policy

Draft