

Detached Motion Sensor with  Bluetooth® 5.0 SIG Mesh

HC038V  
1-10V Output

HCD038  
DALI Output

HCD038/P

**HYTRONIK**®



### Product Description

HC038V is a 1-10V control base whereas HCD038 and HCD038/P are DALI control bases with different DALI power supply built in. They work with a wide range of microwave and PIR sensor heads. They are ideal for metal luminaire designs because the Bluetooth module is placed inside the sensor heads instead of control base, so that the Bluetooth signal transmission is viable. They are suitable for any typical indoor applications such as office, classroom, car park, warehouse and other commercial/industrial areas. With Bluetooth wireless mesh networking, it makes communication much easier without any hardwiring, which eventually adds values to luminaires and saves costs for projects. Meanwhile, simple device setup and commissioning can be done via **Koolmesh**® app.

































HC038V

HCD038









HCD038/P

### App Features





-  Quick setup mode & advanced setup mode
-  Web app/platform for project deployment & data analysis
-  Koolmesh Pro app on iPad for on-site configuration
-  Floorplan feature to simplify project planning
-  DALI-2 supported coming soon
-  One-key device replacement
-  Device social relations check
-  Staircase function (primary & secondary)
-  Remote control via gateway support HBGW01
-  Heat map
-  Dynamic daylight harvest auto-adaptation
-  Grouping luminaires via mesh network
-  Scenes
-  Dusk/Dawn photocell (Twilight function)
-  Tri-level control
-  Daylight harvest
-  Push switch configuration
-  Detailed motion sensor settings
-  Schedule
-  Astro timer (sunrise and sunset)
-  Power-on status (memory against power loss)
-  Offline commissioning
-  Bulk commissioning (copy and paste settings)
-  Different permission levels via authority management
-  Network sharing via QR code or keycode
-  Interoperability with Hytronik Bluetooth product portfolio

-  Compatible with EnOcean BLE switches
-  Internet-of-Things (IoT) featured
-  Device firmware update over-the-air (OTA)
-  Continuous development in progress...





### Hardware Features

-  HC038V: 1-10V output with 400VA (capacitive) & 800W (resistive)
-  DALI bus power supply: (HCD038/P)  
I max: 80mA  
U rated: 1.5VDC  
I guaranteed: 64mA
-  Plug'n'Play for flexible installation and cost saving assemble
-  Support to control DT8 LED drivers (HCD038 and HCD038/P)
-  2 Push inputs for flexible manual control (HCD038/P only)
-  Zero crossing detection circuit to reduce in-rush current and prolong relay lifetime (HC038V only)
-  Loop-in and loop-out terminals for efficient installation (HC038V only)
-  5-year warranty

 Bluetooth® Kinetic Switch









|   |   |  |   |   |
|---|---|--|---|---|
|  |  |  |  |  |
| HBKS01  | HBKS02  | HBKS03   | HBKS01D   | HBKS02D   |

---

|   |   |  |   |
|---|---|--|---|
|  |  |  |  |
|---|---|--|---|

Fully support EnOcean self-powered switch module  
PTM215B (HBES01/W & HBES01/B)

 Bluetooth 5.0 SIG mesh

|   |   |   |   |
|---|---|---|---|
|  |  |  |  |
| Smartphone app for both iOS & Android platform  |   |   |   |
|  |   |  |   |
| Koolmesh Pro app for iPad   |   |   |   |
|  |  |   |  |
| Web app/platform: <a href="http://www.iot.koolmesh.com">www.iot.koolmesh.com</a>      |   |   |   |

## Technical Specifications

| Input & Output Characteristics |   |
|--------------------------------|---|
| Operating voltage              | 220~240VAC 50/60Hz  |
| Stand-by power                 | <0.5W   |
| Load ratings:                  |   |
| HC038V                         | 400VA (capacitive)<br>800W (resistive)                                    |
| HCD038                         | max.30mA  |
| HCD038/P                       | DALI bus power supply:<br>I max:80mA<br>U rated:15VDC<br>I guranteed:64mA |
| Warming-up                     | 20s   |

| Safety & EMC          |  |
|-----------------------|--|
| EMC standard (EMC)    | EN55015, EN61000, EN61547                        |
| Safety standard (LVD) | EN60669-1/-2-1, AS/NZS60669-1/-2-1               |
| Radio Equipment (RED) | EN300440, EN301489-1/-3/-17<br>EN62479, EN300328 |
| Certification         | Semko, CB, CE, EMC, RED, RCM                     |

| Environment             |                   |
|-------------------------|-------------------|
| Operation temperature   | Ta: -20°C ~ +55°C |
| Case temperature (Max.) | Tc: +75°C         |
| IP rating               | IP20              |

## Mechanical Structure & Dimensions

HC038V (1-10V output with 1 push)

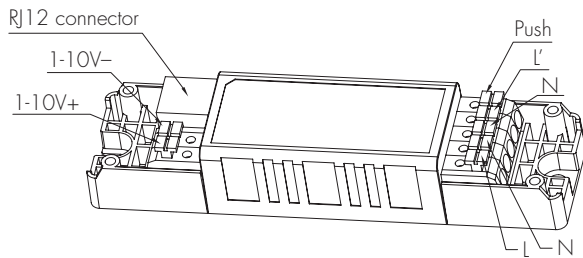

HCD038 (DALI output with 1 push)

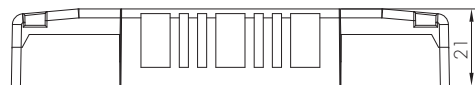
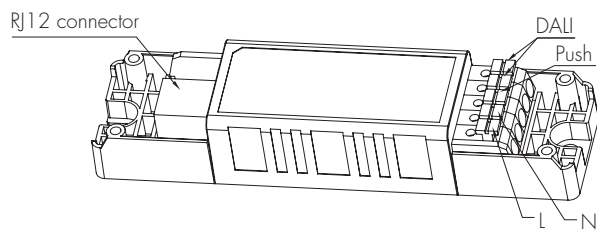

HCD038/P (DALI output with 2 push)

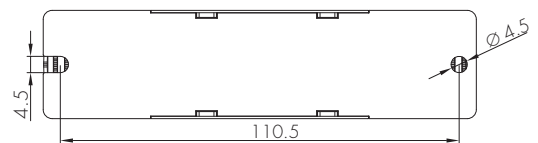
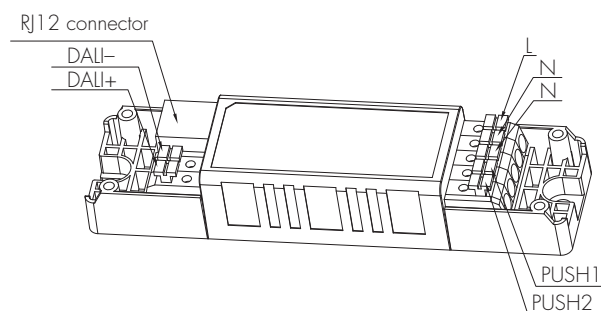

## Wire Preparation

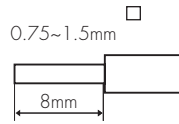
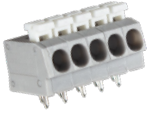

To make or release the wire from the terminal, use a screwdriver to push down the button.

1. 200 metres (total) max. for 1mm<sup>2</sup> CSA (Ta = 50°C)
2. 300 metres (total) max. for 1.5mm<sup>2</sup> CSA (Ta = 50°C)

## Wiring Diagram

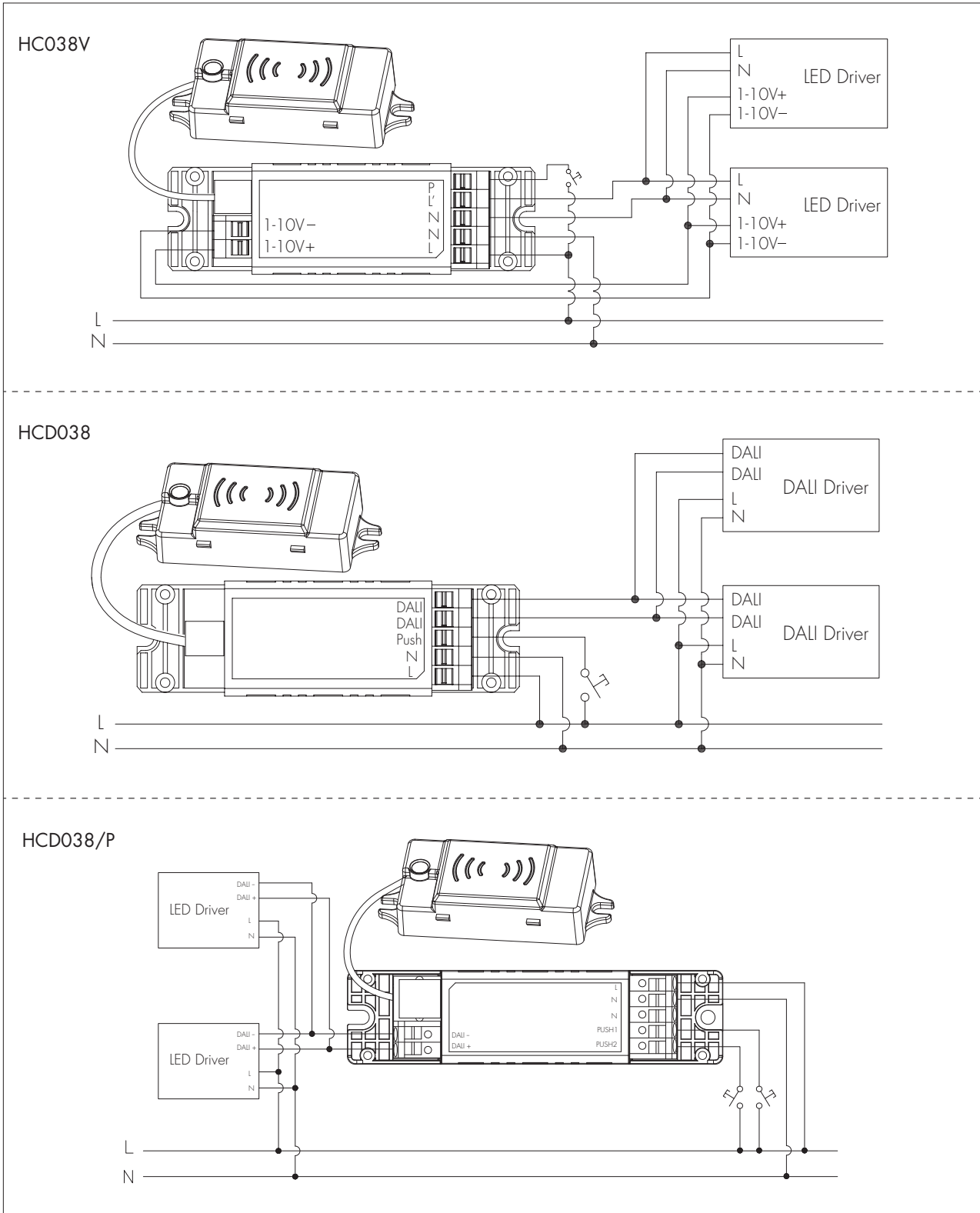

## Technical Specifications for Sensor Heads

| Bluetooth Transceiver  |   |
|------------------------|---|
| Operation frequency    | 2.4 GHz - 2.483 GHz   |
| Transmission power     | 4 dBm   |
| Range (Typical indoor) | 10~30m  |
| Protocol               |  Bluetooth® 5.0 SIG Mesh |

| Environment           |                   |
|-----------------------|-------------------|
| Operation temperature | Ta: -20°C ~ +55°C |
| Storage temperature   | -20°C ~ +70°C     |
| Relative humidity     | 0 ~ 90%           |
| IP rating             | IP20              |

| HF Sensor Properties (HBT01) |  |
|------------------------------|--|
| Sensor principle             | High Frequency (microwave)                                 |
| Operation frequency          | 5.8GHz +/- 75MHz   |
| Transmission power           | <0.2mW   |
| Detection range*             | Max installation height: 3m<br>Max detection range (Ø): 8m |
| Detection angle              | 30° ~ 150°   |

| PIR Sensor Properties (HIR13 & HIR16 & HIR62 & HIR62/R) |   |      |
|---|---|------|
| Sensor principle  | PIR detection   |      |
| Operation voltage                                       | 5VDC  |      |
| Detection range *                                       | HIR13<br>Max installation height: 15m (forklift)<br>12m (single person)<br>Max detection range (Ø): 24m                           |      |
|   | HIR16<br>Max installation height: 15m (forklift)<br>12m (single person)<br>Max detection range: 18m * 6m (L * W)                  |      |
|   | HIR62<br>Max installation height: 3m (single person)<br>Max detection range (Ø): 12m  |      |
|   | HIR62/R<br>Max installation height: 8m (single person)<br>Max installation height: 12m (forklift)<br>Max detection range (Ø): 14m |      |
|   | Detection angle   | 360° |

\* The detection range is heavily influenced by sensor placement (angle) and different walking paces. It may be reduced under certain conditions.

## PIR & microwave sensor heads

The range of PIR and microwave sensor heads below with Bluetooth modules built in offers powerful number of Plug'n'Play feature options to expand the flexibility of luminaire design. This approach to luminaire design reduces space requirements and component costs whilst simplifying production.

### A. HBT01

Surface mounting  
Photocell Advance™  
The cable length is around 30cm.

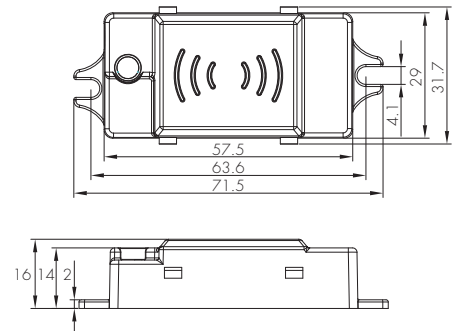
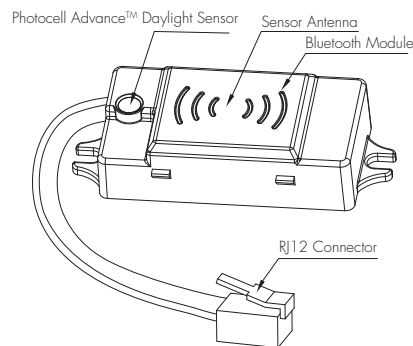

### B. HBT02

Surface mounting  
Without motion sensor  
Photocell Advance™  
The cable length is around 30cm.

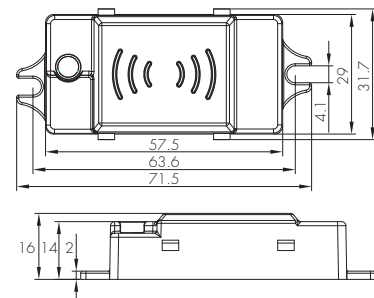
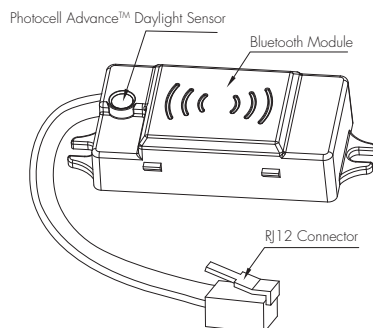

### C. HIR13/S

Surface mounting  
 For highbay application  
 IP65 (facia / lens part)  
 The cable length is around 30cm.

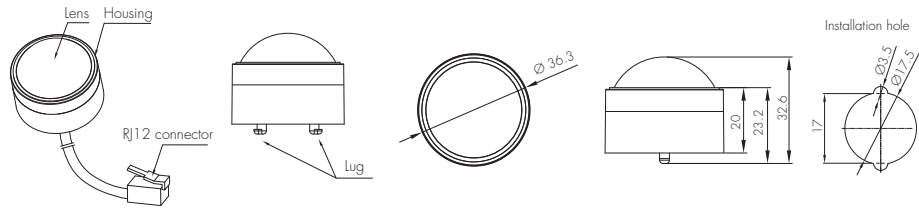

### D. HIR13/F

Flush mounting  
 For highbay application  
 IP65 (facia / lens part)  
 The cable length is around 30cm.

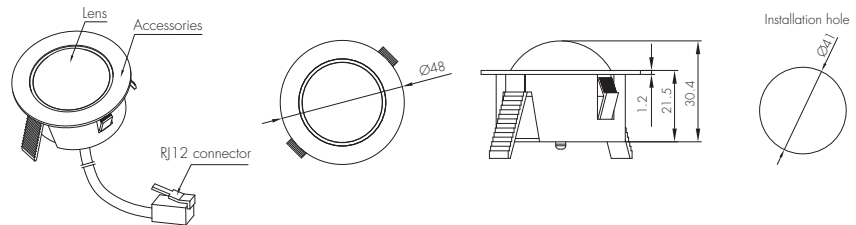

### E. HIR13/C

Screw to the luminaire by conduit  
 For highbay application  
 IP65 (facia / lens part)  
 The cable length is around 30cm.

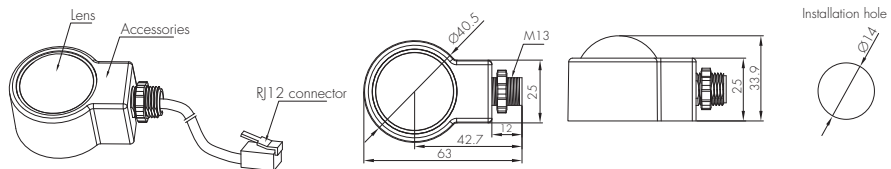

### F. HIR13/AA

PIR sensor head  
 Adjustable angle  
 The cable length is around 30cm.

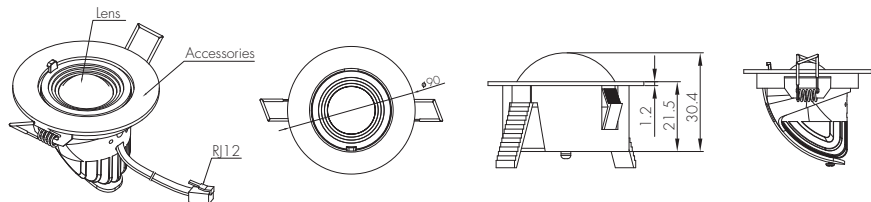

### G. HIR16

PIR sensor head  
 Keep real time for up to 2 weeks  
 against power failure  
 For highbay application  
 IP65 (facia / lens part)  
 The cable length is around 30cm.

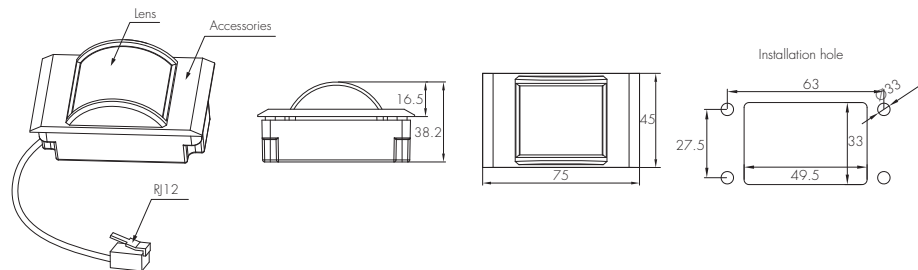

**Installation for HIR16**

Thickness: 0.8mm – 1.6mm

We suggest that the metal plate thickness to be 0.8mm – 1.6mm to ensure perfect focal length for the PIR lens.

### H. HIR62

PIR sensor head  
The cable length is around 30cm.

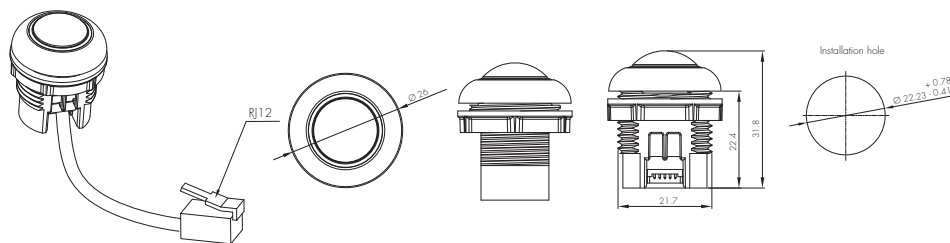

### I. HIR62 with HA04

PIR sensor head  
Optional accessory  
The cable length is around 30cm.

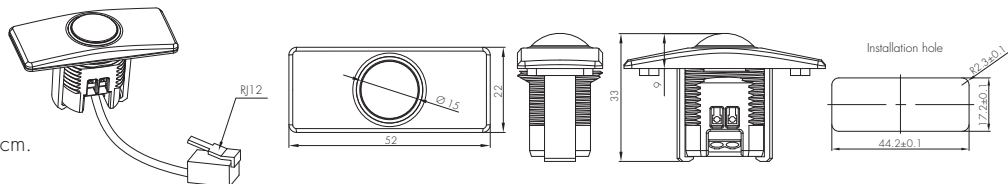

### J. HIR62 with HA05

PIR sensor head  
Optional accessory  
The cable length is around 30cm.

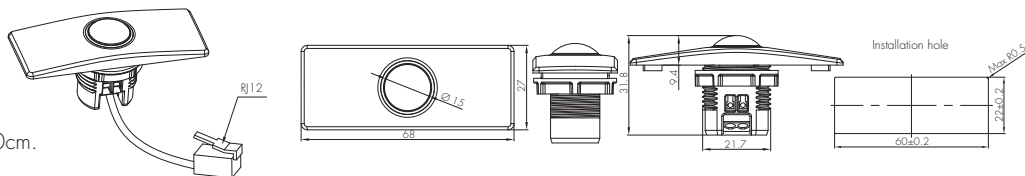

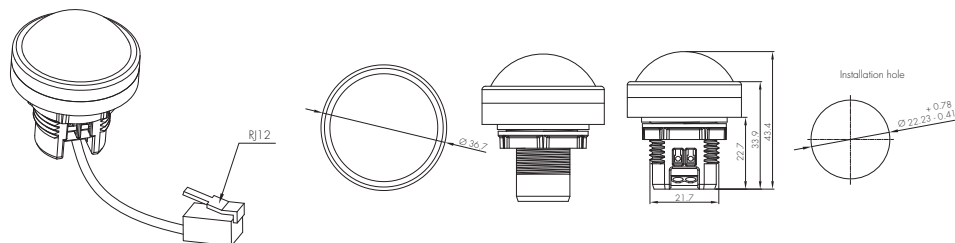

### K. HIR62/R

PIR sensor head  
IP65 (facia / lens part)  
The cable length is around 30cm.

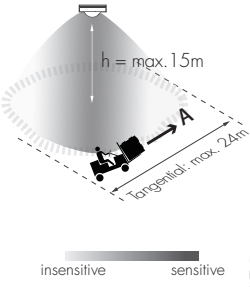
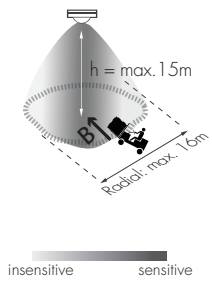

Note: When HIR62 or HIR62/R plug with HCD038/P, only one push terminal can be activated for configuration.

Detection Pattern

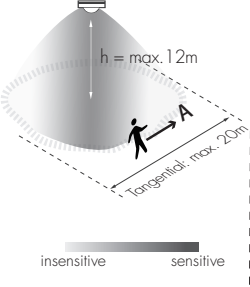
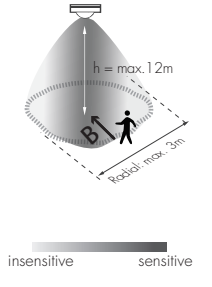
| HIR13 (High-bay)  |   |  |                                   |                                 |
|---|---|--|-----------------------------------|---------------------------------|
|    |   | <b>HIR13: High-bay lens detection pattern for <u>forklift</u> @ Ta = 20°C</b><br>(Recommended installation height <b>10m-15m</b> )       |                                   |                                 |
| A: Tangential movement  | B: Radial movement  | Mount height   | Tangential (A)                    | Radial (B)                      |
|    |    | 10m  | max 380m <sup>2</sup> (Ø = 22m)   | max 201m <sup>2</sup> (Ø = 16m) |
|   |   | 11m  | max 452m <sup>2</sup> (Ø = 24m)   | max 201m <sup>2</sup> (Ø = 16m) |
|   |   | 12m  | max 452m <sup>2</sup> (Ø = 24m)   | max 201m <sup>2</sup> (Ø = 16m) |
|   |   | 13m  | max 452m <sup>2</sup> (Ø = 24m)   | max 177m <sup>2</sup> (Ø = 15m) |
|   |   | 14m  | max 452m <sup>2</sup> (Ø = 24m)   | max 133m <sup>2</sup> (Ø = 13m) |
|   |   | 15m  | max 452m <sup>2</sup> (Ø = 24m)   | max 113m <sup>2</sup> (Ø = 12m) |
|    |   | <b>HIR13: High-bay lens detection pattern for <u>single person</u> @ Ta = 20°C</b><br>(Recommended installation height <b>2.5m-12m</b> ) |                                   |                                 |
| A: Tangential movement  | B: Radial movement  | Mount height   | Tangential (A)                    | Radial (B)                      |
|  |  | 2.5m   | max 50m <sup>2</sup> (Ø = 8m)     | max 7m <sup>2</sup> (Ø = 3m)    |
|   |   | 6m   | max 104m <sup>2</sup> (Ø = 11.5m) | max 7m <sup>2</sup> (Ø = 3m)    |
|   |   | 8m   | max 154m <sup>2</sup> (Ø = 14m)   | max 7m <sup>2</sup> (Ø = 3m)    |
|   |   | 10m  | max 227m <sup>2</sup> (Ø = 17m)   | max 7m <sup>2</sup> (Ø = 3m)    |
|   |   | 11m  | max 269m <sup>2</sup> (Ø = 18.5m) | max 7m <sup>2</sup> (Ø = 3m)    |
|   |   | 12m  | max 314m <sup>2</sup> (Ø = 20m)   | max 7m <sup>2</sup> (Ø = 3m)    |

### HIR16

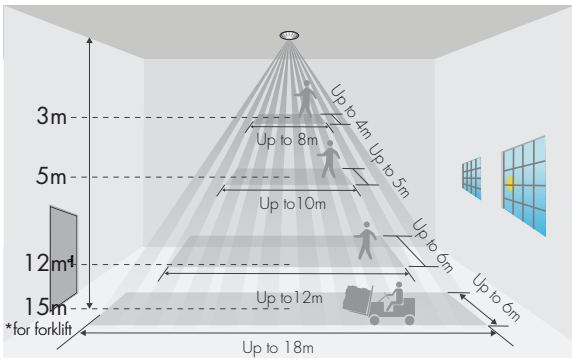

\*The detection patterns are based upon 5km/h movement speed.

### HIR62

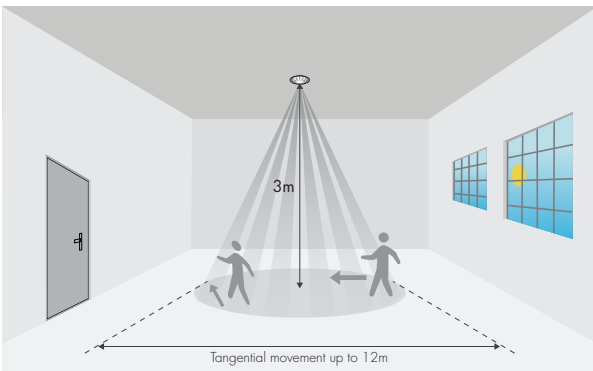

### HIR62/R

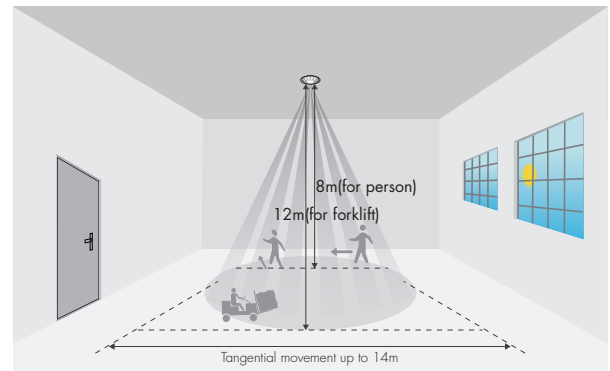

\*The detection patterns are based upon 5km/h movement speed.

### HBT01

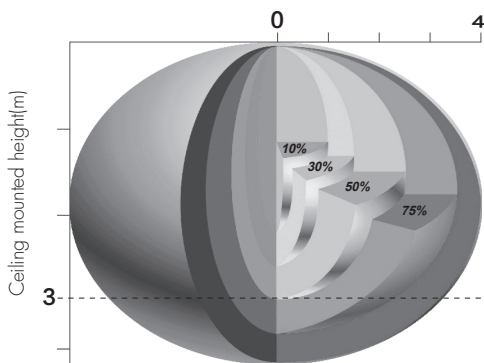

The detection range is heavily influenced by sensor placement (angle) and different walking paces.

It may be reduced to 2m(diameter) & 3m(height) under certain conditions (walking across).



## Dimming Interface Operation Notes

### Switch-Dim

The provided Switch-Dim interface allows for a simple dimming method using commercially available non-latching (momentary) wall switches. Detailed Push switch configurations can be set on Koolmesh app.

| Switch Function              | Action  | Descriptions  |
|------------------------------|---|---|
| Push switch                  | Short press (<1 second)<br>* Short press has to be longer than 0.1s, or it will be invalid. | - Turn on/off<br>- Turn on only<br>- Turn off only<br>- Recall a scene<br>- Quit manual mode<br>- Do nothing  |
|                              | Double push   | - Turn on only<br>- Turn off only<br>- Recall a scene<br>- Quit manual mode<br>- Do nothing   |
|                              | Long press (≥1 second)  | - Dimming<br>- Colour tuning<br>- Do nothing  |
| Sensor-link                  | /   | - Upgrade a normal on/off motion sensor to a Bluetooth controlled motion sensor   |
| Emergency Self-Test Function | Short press (<1 second)<br>* Short press has to be longer than 0.1s, or it will be invalid. | - Start Self test (Monthly)<br>- Stop Self test<br>- Start Self test (Annually)<br>- Invalid  |
|                              | Long press (≥1 second)  | - Start Self test (Monthly)<br>- Stop Self test<br>- Start Self test (Annually)<br>- Invalid  |
| Fire Alarm (VFC signal only) | Refer to <b>Koolmesh</b> ® App User Manual V2.1   | - Able to connect the Fire Alarm system<br>- Once the fire alarm system is triggered, all the luminaries controlled by the Push Switch will enter the preset scene (normally it's full on), after the fire alarm system gives the ending signal, all the luminaries controlled by this Push Switch will revert back to normal status. |

## Additional Information / Documents

- For full explanation of Hytronik Photocell Advance™ technology, please kindly refer to [www.hytronik.com/download ->knowledge ->Introduction of Photocell Advance](http://www.hytronik.com/download->knowledge->Introduction%20of%20Photocell%20Advance)
- To learn more about detailed product features/functions, please refer to [www.hytronik.com/download ->knowledge ->Introduction of App Scenes and Product Functions](http://www.hytronik.com/download->knowledge->Introduction%20of%20App%20Scenes%20and%20Product%20Functions)
- Regarding precautions for Bluetooth product installation and operation, please kindly refer to [www.hytronik.com/download ->knowledge ->Bluetooth Products - Precautions for Product Installation and Operation](http://www.hytronik.com/download->knowledge->Bluetooth%20Products%20-%20Precautions%20for%20Product%20Installation%20and%20Operation)
- Regarding precautions for microwave sensor installation and operation, please kindly refer to [www.hytronik.com/download ->knowledge ->Microwave Sensors - Precautions for Product Installation and Operation](http://www.hytronik.com/download->knowledge->Microwave%20Sensors%20-%20Precautions%20for%20Product%20Installation%20and%20Operation)
- Regarding precautions for PIR Sensors installation and operation, please kindly refer to [www.hytronik.com/download ->knowledge ->PIR Sensors - Precautions for Product Installation and Operation](http://www.hytronik.com/download->knowledge->PIR%20Sensors%20-%20Precautions%20for%20Product%20Installation%20and%20Operation)
- Data sheet is subject to change without notice. Please always refer to the most recent release on [www.hytronik.com/products/bluetooth technology ->Bluetooth Sensors](http://www.hytronik.com/products/bluetooth%20technology->Bluetooth%20Sensors)
- Regarding Hytronik standard guarantee policy, please refer to [www.hytronik.com/download ->knowledge ->Hytronik Standard Guarantee Policy](http://www.hytronik.com/download->knowledge->Hytronik%20Standard%20Guarantee%20Policy)

## Tri-level Control Sensor

HC038V HCD038

Detached Linear Version with Remote Control

# HYTRONIK®

CE UK RED IP20











### Applications

Occupancy detector with tri-level dimming control suitable for indoor use:

- Office / Commercial Lighting
- Classroom
- Meeting Room

Use for new luminaire designs and installations

### Features

-  24 hour daylight monitoring dawn/dusk sensor
-  Special photocell to measure and differentiate natural light from LED light
-  Lux off function, daylight threshold prior to motion detection
-  Tri-level dimming control based upon occupancy (also known as corridor function)
-   Optional 1-10V or DALI dimming control method
-  One-touch daylight learning via remote control
-  Zero crossing detection circuit reduces in-rush current and prolongs relay life (HC038V)
-  Loop-in and loop-out terminal for efficient installation (HC038V)
-  5-year warranty



HC038V



HCD038

### Technical Data

#### Input Characteristics

| Model No.      | HC038V HCD038                          |
|----------------|--|
| Mains voltage  | 220~240VAC 50/60Hz                     |
| Stand-by power | <0.5W                                  |
| Load ratings:  |  |
| HC038V         | 400VA (capacitive)<br>800W (resistive) |
| HCD038         | 30mA, 16VDC (max. 15 devices)          |
| Warming-up     | 20s                                    |

#### Environment

|                         |                   |
|-------------------------|-------------------|
| Operation temperature   | Ta: -20°C ~ +55°C |
| Case temperature (Max.) | Tc: +80°C         |
| IP rating               | IP20              |

#### Safety and EMC

|                       |                                    |
|-----------------------|------------------------------------|
| EMC standard (EMC)    | EN55015, EN61000-3-2/-3-3          |
| Safety standard (LVD) | EN60669-1/-2-1, AS/NZS60669-1/-2-1 |
| Radio Equipment (RED) | EN300440, EN301489-1/-3, EN62479   |
| Certification         | CB, CE, EMC, LVD, RCM              |

#### Sensor Data

| Model No.  | SAM7<br>HIRO2                         | SAM7/I<br>SAM7/FM<br>HIRO4 | SAM7/AA<br>HIR19 |
|--|---------------------------------------|----------------------------|------------------|
| Sensor principle:                                  | High Frequency (microwave)            |                            |                  |
| HIRO2 HIRO4 HIR19                                  | PIR Detection                         |                            |                  |
| Operation frequency                                | 5.8GHz +/- 75MHz                      |                            |                  |
| Transmission power                                 | <0.2mW                                |                            |                  |
| Detection range:                                   |                                       |                            |                  |
| SAM7 SAM7/I<br>SAM7/FM SAM7/AA                     | 6m                                    |                            |                  |
| Max installation height<br>Max Detection range (Ø) | 12m (Diameter)                        |                            |                  |
| HIRO2 HIRO4  | 3m                                    |                            |                  |
| Max installation height<br>Max Detection range (Ø) | 6m (Diameter)                         |                            |                  |
| HIR19  | 15m (forklift)<br>12m (single person) |                            |                  |
| Max installation height<br>Max Detection range (Ø) | 24m (forklift)<br>20m (single person) |                            |                  |
| Detection angle                                    | 30° ~ 150°                            |                            |                  |

## Sensor Main Body

HC038V (1-10V output)

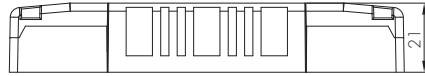
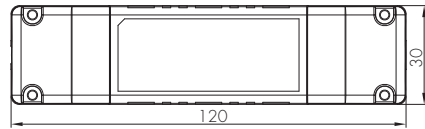
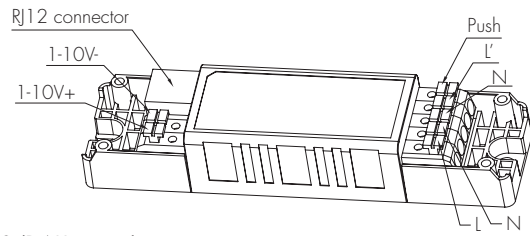

HCD038 (DALI output)

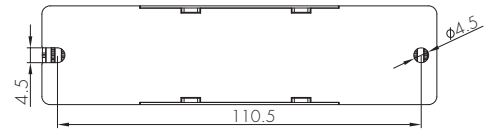
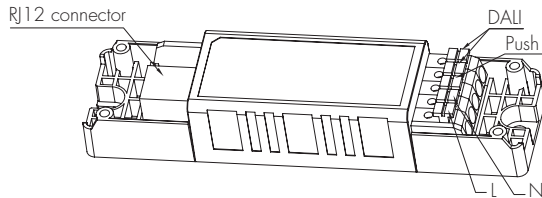

There are eight different sensor antenna modules to choose from:

HF sensorDIM™  
Model SAM7

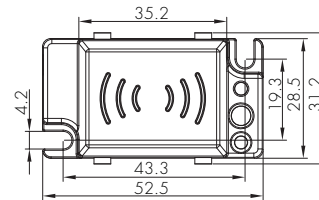
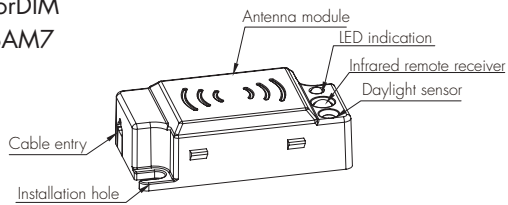

HF sensorDIM™  
Model SAM7/I

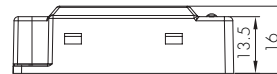
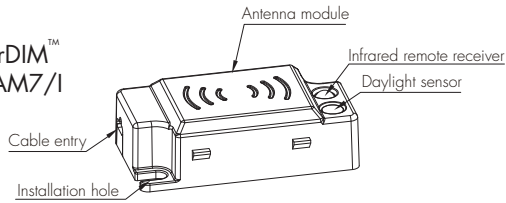

HF sensorDIM™  
Model SAM7/AA

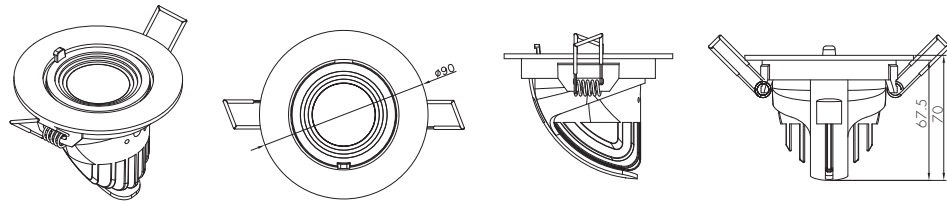

HF sensorDIM™  
Model SAM7/FM

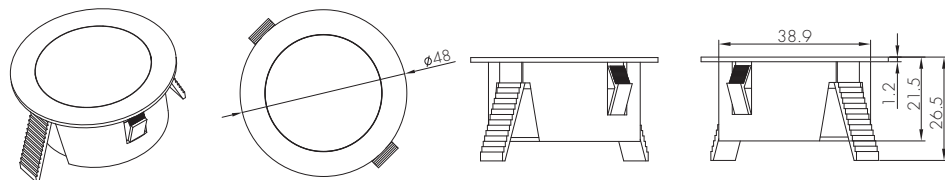

PIR Sensor Head  
Model HIR02

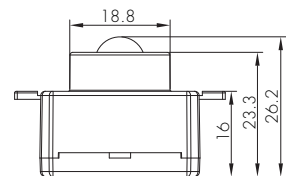
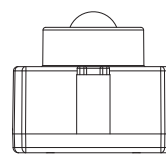
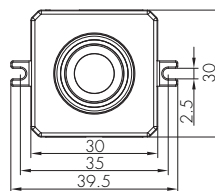
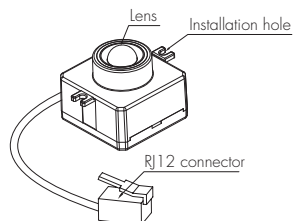

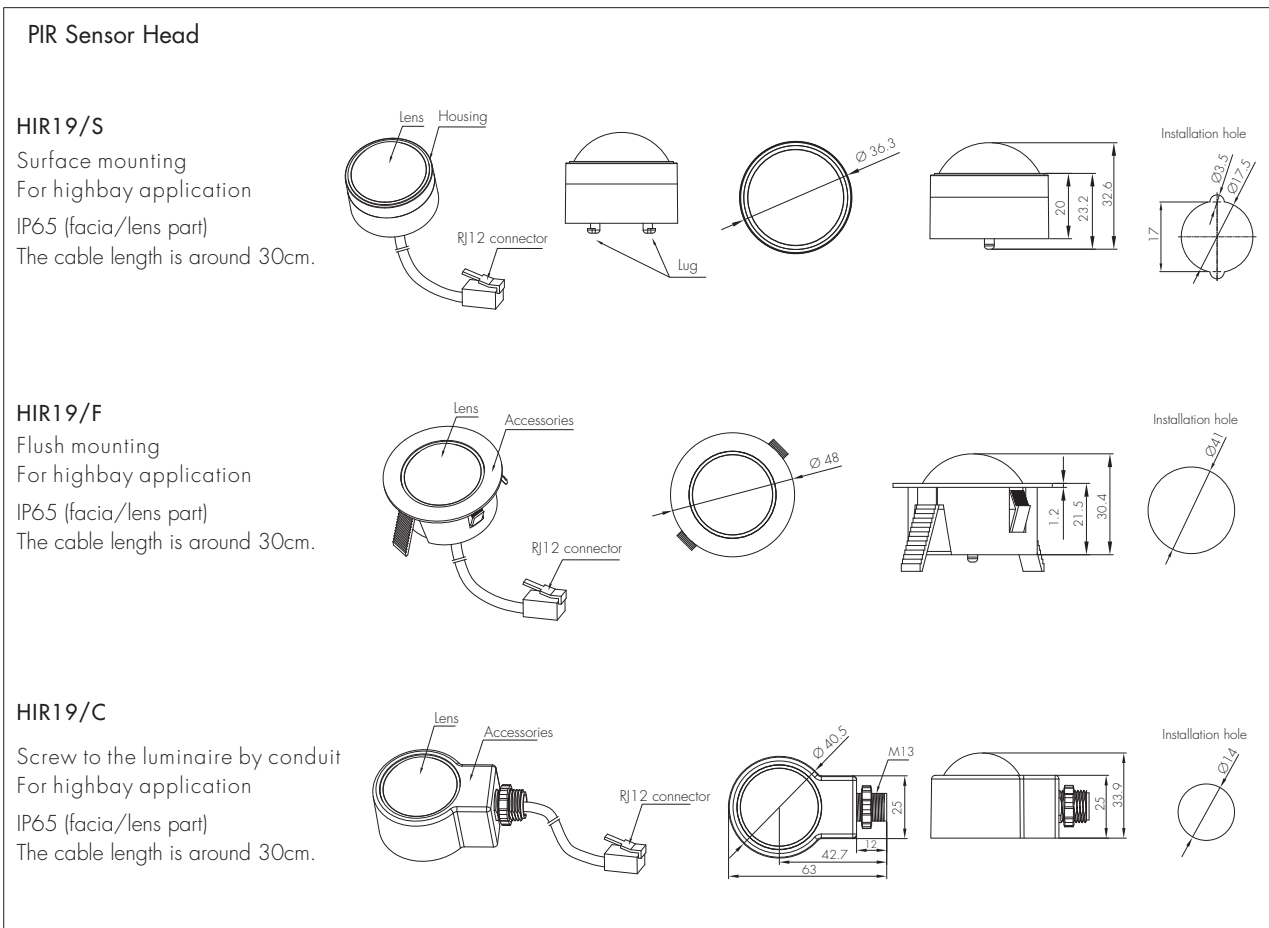
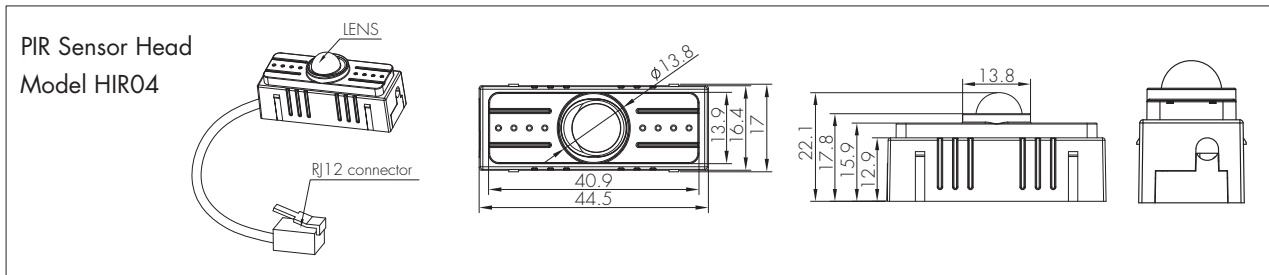

**8 sensor antennas and 2 control units offer 16 combinations in total:**

- |  |   |
|--|---|
| <b>A</b> Microwave antenna SAM7 + DALI control HCD038    | <b>B</b> Microwave antenna SAM7 + 1-10V control HC038V    |
| <b>C</b> Microwave antenna SAM7/I + 1-10V control HC038V | <b>E</b> Microwave antenna SAM7/AA + 1-10V control HC038V |
| <b>D</b> Microwave antenna SAM7/AA + DALI control HCD038 | <b>G</b> Microwave antenna SAM7/FM + 1-10V control HC038V |
| <b>F</b> Microwave antenna SAM7/FM + DALI control HCD038 | <b>I</b> PIR antenna HIRO2 + 1-10V control HC038V         |
| <b>H</b> PIR antenna HIRO2 + DALI control HCD038         | <b>K</b> PIR antenna HIRO4 + 1-10V control HC038V         |
| <b>J</b> PIR antenna HIRO4 + DALI control HCD038         | <b>M</b> PIR antenna HIR19/S + 1-10V control HC038V       |
| <b>L</b> PIR antenna HIR19/S + DALI control HCD038       | <b>O</b> PIR antenna HIR19/F + 1-10V control HC038V       |
| <b>N</b> PIR antenna HIR19/F + DALI control HCD038       | <b>Q</b> PIR antenna HIR19/C + 1-10V control HC038V       |
| <b>P</b> PIR antenna HIR19/C + DALI control HCD038       |   |

Note: SAM7/I have compatibility issues with HCD038 OR other standard DALI-2 LED drivers



Note: We recommend the mounting distance between sensor to sensor should be more than 2m to prevent sensors from false-triggering.

## Functions and Features

### 1 Tri-level Control (Corridor Function)

Hytronik builds this function inside the motion sensor to achieve tri-level control, for some areas which require a light change notice before switch-off. The sensor offers 3 levels of light: 100%→dimmed light (natural light is insufficient) →off; and 2 periods of selectable waiting time: motion hold-time and stand-by period; Selectable daylight threshold and freedom of detection area.

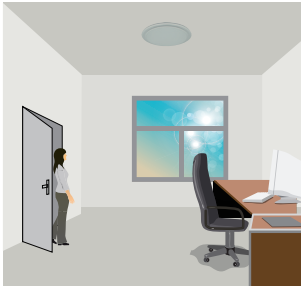

With sufficient natural light, the light does not switch on when presence is detected.

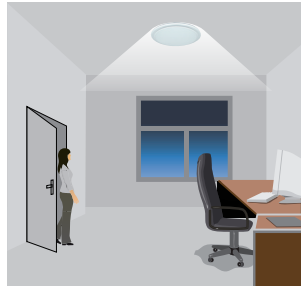

With insufficient natural light, the sensor switches on the light automatically when presence is detected.

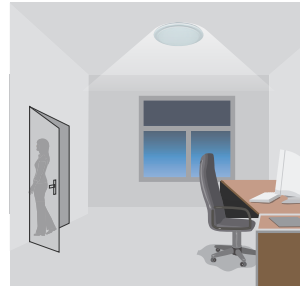

After hold-time, the light dims to stand-by level if the surrounding natural light is below the daylight threshold.



Light switches off automatically after the stand-by period elapses.

### 2 24h Daylight Monitoring Function (SAM7)

Our innovative and patented software enables our antenna with built-in daylight sensor to provide a "smart photocell" function. This function is activated when stand-by period is set to "+∞".

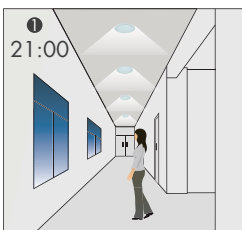

The light switches on at 100% when there is movement detected.



The light dims to stand-by level after the holdtime.

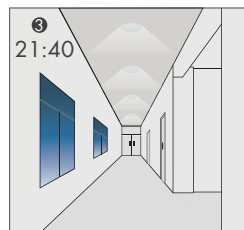

The light remains in dimming level at night.

#### Settings on this demonstration:

Hold-time: 10min

Daylight threshold: 50lux

Stand-by dimming level: 10%

Stand-by period: +∞

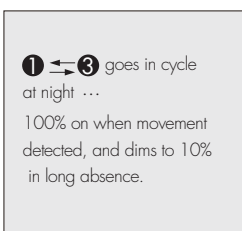

1 ↔ 3 goes in cycle at night ...  
100% on when movement detected, and dims to 10% in long absence.



The light turns off completely when natural light lux exceeds daylight threshold pre-set.



The light automatically turns on at 10% when natural light is insufficient (no motion).

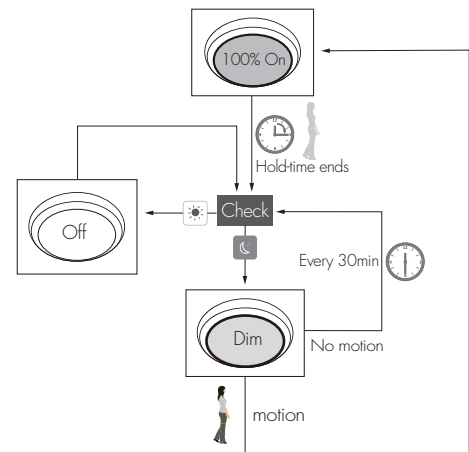

### 3 Photocell Advance™ Function (SAM7/I, HIRO4)

It's well known that LED lights have a totally different spectrum to natural light. Hytronik uses this principle and comes up with special photocell and sophisticated software algorithm to measure and differentiate natural light from LED light, so that this photocell can ignore the LED light and only respond to the natural light.

Our technology has no infringement to the existing patents in the market.

### 4 Lux Off Function (SAM7/I, HIRO2, HIRO4)

The light turns off automatically whenever surrounding natural light lux level exceeds the daylight threshold for more than 5min, even there is motion detected. For HIRO2 and HIRO4, please pay attention that if the stand-by period is pre-set to infinity "+∞", the fixture never switches off but stays at dimming level, even when natural light is sufficient.

## 5 Manual Override

This sensor reserves the access of manual override function for end-user to switch on/off, or adjust the brightness by push-switch, which makes the product more user-friendly and offers more options to fit some extra-ordinary demands:

\* Short Push (< 1s): on/off function;

On → Off: the light turns off immediately and cannot be triggered ON by motion until the expiration of pre-set hold-time. After this period, the sensor goes back to normal sensor mode.

Off → On: the light turns on and goes to sensor mode, no matter if ambient Lux level exceeds the daylight threshold or not.

\* Long Push (> 1s): adjust the hold-time brightness level between 10% and 100%.

*Note: if end-user do not want this manual override function, just leave the "push" terminal unconnected to any wire.*

## 6 Semi-auto Mode (Absence Detection)

It is easy to forget to switch off the light, in office, corridor, even at home. And in many other cases, people do not want to have a sensor to switch on the light automatically, for example, when people just quickly pass-by, there is no need to have the light on. The solution is to apply this "absence detector": motion sensor is employed, but only activated on the manual press of the push switch, the light keeps being ON in the presence, and dims down in the absence, and eventually switches off in the long absence. This is a good combination of sensor automation and manual override control, to have the maximum energy saving, and at the same time, to keep efficient and comfortable lighting.

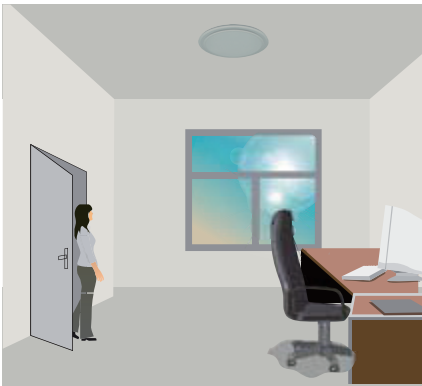

The light does not switch on when there is presence being detected.



Short push to activate the sensor and switch on the light

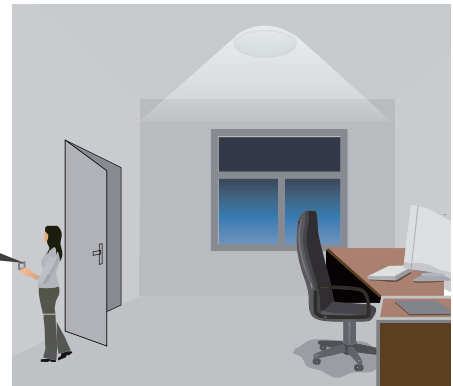

The light turns on full, and the sensor stays in sensor mode.



The light keeps being ON during the presence.

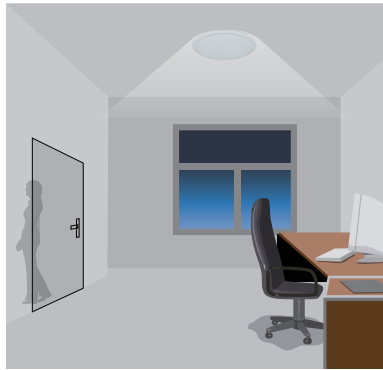

People left, the light dims to stand-by level after the hold-time.



The light switches off automatically after the stand-by period elapses.

*Note: end-user can choose either function 5 or function 6 for application. Default function is manual override.*

## 7 Zero-cross Relay Operation (HC038V)

Designed in the software, sensor switches on/off the load right at the zero-cross point, to ensure that the in-rush current is minimised, enabling the maximum lifetime of the relay.

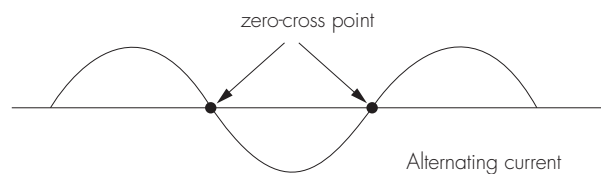

## 8 Loop-in and Loop-out Terminal (HC038V)

Double L N terminal makes it easy for wire loop-in and loop-out, and saves the cost of terminal block and assembly time.

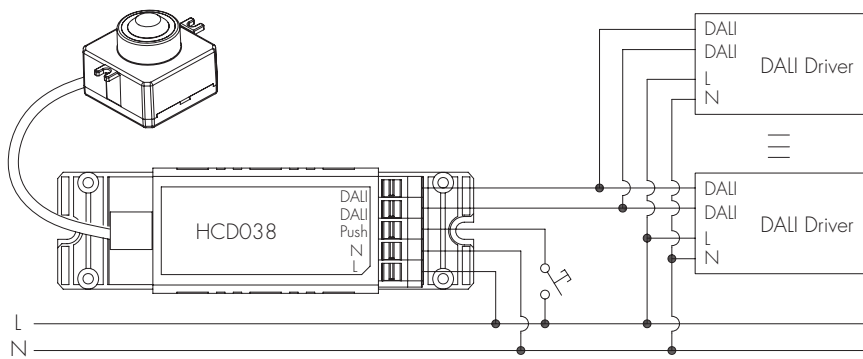
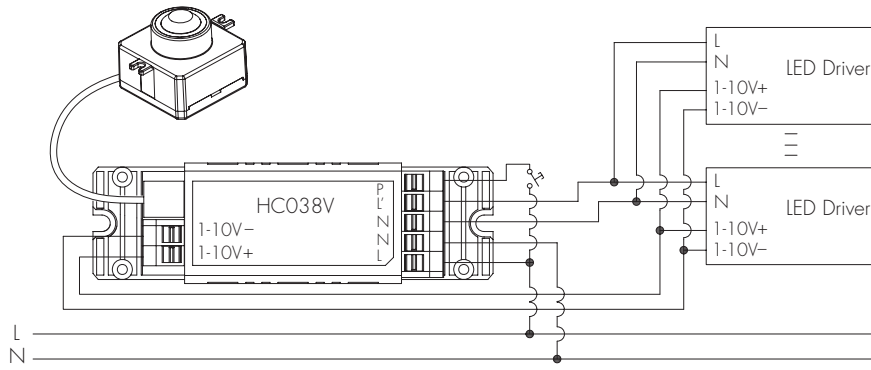

1. 200 metres (total) max. for 1mm<sup>2</sup> CSA (Ta = 50°C)
2. 300 metres (total) max. for 1.5mm<sup>2</sup> CSA (Ta = 50°C)

Detection Pattern (Ceiling mounted)

Model SAM7 & SAM7/I

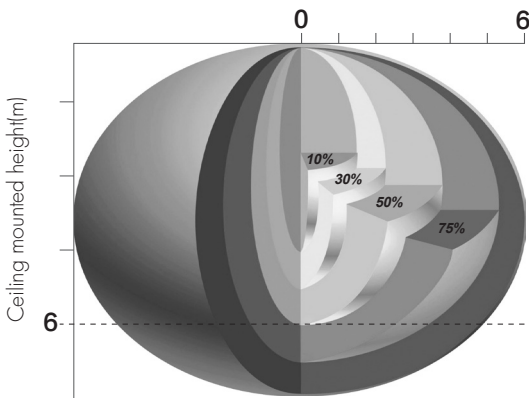

Model HIR02 & HIR04

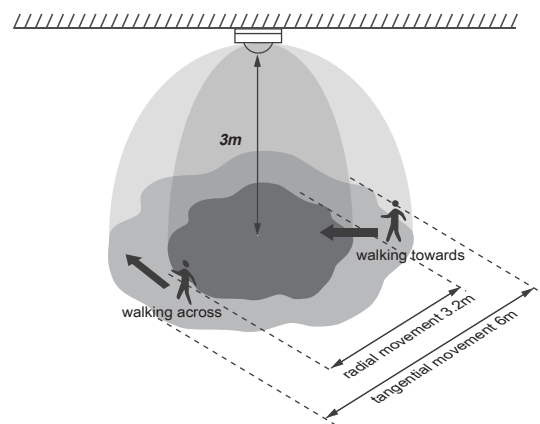

Model SAM7/AA

Sensitivity set to maximum, Sensor head angle set to maximum

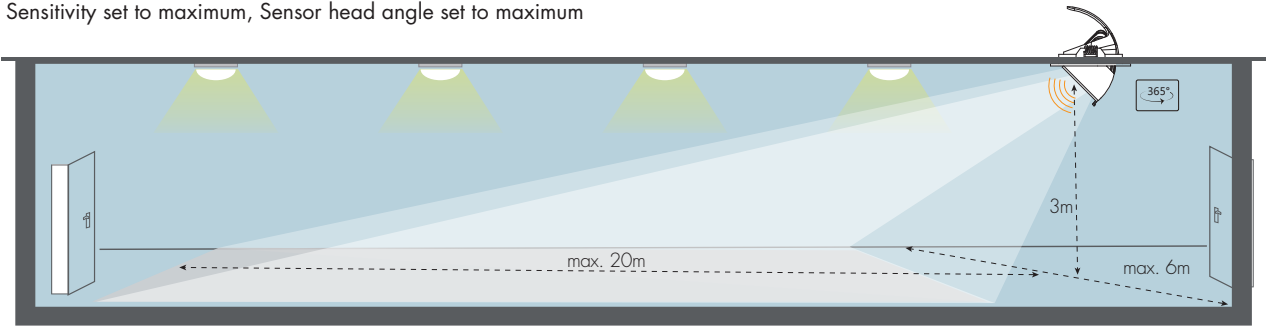

Model SAM7/FM

Sensitivity set to maximum, Sensor head angle set to maximum

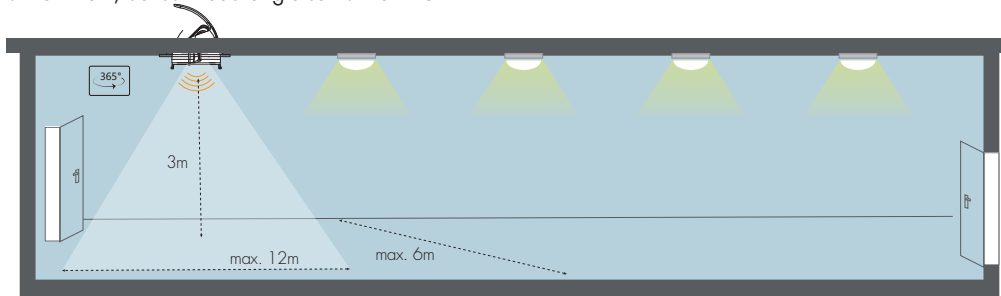

### HIR19 (High-bay)



**HIR19:** High-bay lens detection pattern for **forklift** @ Ta = 20 °C

(Recommended installation height **10m-15m**)

| A: Tangential movement | B: Radial movement | Mount height | Tangential (A)                  | Radial (B)                      |
|------------------------|--------------------|--------------|---------------------------------|---------------------------------|
|                        |                    | 10m          | max 380m <sup>2</sup> (Ø = 22m) | max 201m <sup>2</sup> (Ø = 16m) |
|                        |                    | 11m          | max 452m <sup>2</sup> (Ø = 24m) | max 201m <sup>2</sup> (Ø = 16m) |
|                        |                    | 12m          | max 452m <sup>2</sup> (Ø = 24m) | max 201m <sup>2</sup> (Ø = 16m) |
|                        |                    | 13m          | max 452m <sup>2</sup> (Ø = 24m) | max 177m <sup>2</sup> (Ø = 15m) |
|                        |                    | 14m          | max 452m <sup>2</sup> (Ø = 24m) | max 133m <sup>2</sup> (Ø = 13m) |
|                        |                    | 15m          | max 452m <sup>2</sup> (Ø = 24m) | max 113m <sup>2</sup> (Ø = 12m) |



**HIR19:** High-bay lens detection pattern for **single person** @ Ta = 20 °C

(Recommended installation height **2.5m-12m**)

| A: Tangential movement | B: Radial movement | Mount height | Tangential (A)                    | Radial (B)                   |
|------------------------|--------------------|--------------|-----------------------------------|------------------------------|
|                        |                    | 2.5m         | max 50m <sup>2</sup> (Ø = 8m)     | max 7m <sup>2</sup> (Ø = 3m) |
|                        |                    | 6m           | max 104m <sup>2</sup> (Ø = 11.5m) | max 7m <sup>2</sup> (Ø = 3m) |
|                        |                    | 8m           | max 154m <sup>2</sup> (Ø = 14m)   | max 7m <sup>2</sup> (Ø = 3m) |
|                        |                    | 10m          | max 227m <sup>2</sup> (Ø = 17m)   | max 7m <sup>2</sup> (Ø = 3m) |
|                        |                    | 11m          | max 269m <sup>2</sup> (Ø = 18.5m) | max 7m <sup>2</sup> (Ø = 3m) |
|                        |                    | 12m          | max 314m <sup>2</sup> (Ø = 20m)   | max 7m <sup>2</sup> (Ø = 3m) |



**ON/OFF** Permanent ON/OFF function

Press button "ON/OFF" to select permanent ON or permanent OFF mode.

\* Press button "AUTO", "RESET" or "Ambient" to quit this mode.

The mode will change to AUTO Mode after power failure.

**RESET** Reset Settings

Press button "RESET", all settings go back to default values.

Detection range: 100%; Hold-time: 5min; Stand-by period: 10min; Stand-by dimming level: 10%; Lux disabled

**Shift** Shift Button

Press button "Shift", the LED on the top left corner is on to indicate mode selection.

All values / settings in RED are valid for 20 seconds.

**SEMI-AUTO**  
**AUTO** AUTO mode

Press button "AUTO" to initiate automatic mode. The sensor starts working and all settings remain as before the light is switched ON/OFF.

**SEMI-AUTO**  
**AUTO** SEMI-AUTO mode

1. Press button "Shift", the red LED flashes for indication.
2. Press button "SEMI-AUTO/AUTO" to initiate semi-auto mode. The fixture is manually turned on by pressing the push-switch, and goes off automatically after stand-by time. (Absence detection mode)

**Sensor off** **Twilight**  
**Power 100%** **Power 80%** Power output

Press the buttons to select light output at 80% (at initial 10,000 hours) or 100%.

Note: "Sensor off" and "Twilight" functions are disabled.

**+** **-** Brightness +/-

Press these two buttons to adjust the light output brightness during hold-time.

**Start** **Memory** **Apply** Scene program - 1-key commissioning

1. Press button "Start" to program.
2. Select the buttons in "Detection range", "Daylight threshold", "Hold-time", "Stand-by time", "Stand-by dimming level" to set all parameters.
3. Press button "Memory" to save all the settings programmed in the remote control.
4. Press button "Apply" to set the settings to each sensor unit(s).

For example, to set detection range 100%, daylight threshold Disable, hold-time 5min, stand-by time +∞, stand-by dimming level 30%, the steps should be: Press button "Start", button "100%", "Disable", "Shift", "5min", "Shift", "+∞", "30%", "Memory". By pointing to the sensor unit(s) and pressing "Apply", all settings are passed on the sensor(s).

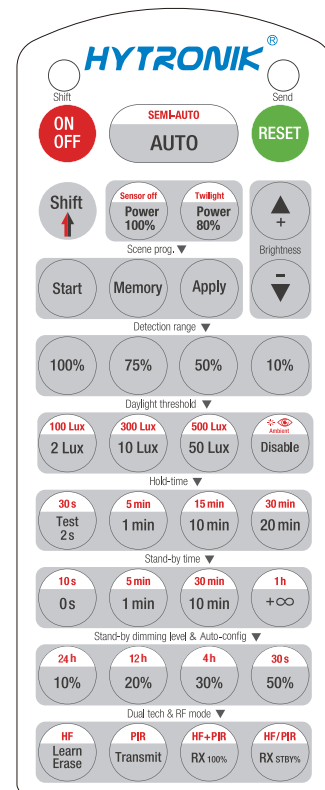

HRC-11

### Detection range

All buttons in this zone are disabled for HIRO4.

### Daylight threshold

Press buttons in zone "Daylight threshold" to set daylight sensor at 2Lux / 10Lux / 50Lux / 100Lux / 300Lux / 500Lux / Disable.

*Note: To set daylight sensor at 100Lux / 300Lux / 500Lux, press "Shift" button first.*

### Ambient daylight threshold

1. Press button "Shift", the red LED starts to flash.

2. Press button "Ambient", the surrounding lux level is sampled and set as the new daylight threshold.

### Hold-time

Press buttons in zone "hold-time" to set the hold-time at 2s / 30s / 1min / 5min / 10min / 15min / 20min / 30min.

*Note: 1. To set hold-time at 30s / 5min / 15min / 30min, press "Shift" button first.*

*2. 2s is for testing purpose only, stand-by period and daylight sensor settings are disabled in this mode.*

\*To exit from Test mode, press button "RESET" or any button in "Hold-time".

### Stand-by time (corridor function)

Press buttons in zone "stand-by time" to set the stand-by period at 0s / 10s / 1min / 5min / 10min / 30min / 1h / +∞.

*Note: "0s" means on/off control; "+∞" means the stand-by time is infinite and the fixture never switches off.*

### Stand-by dimming level

Press the button in zone "stand-by dimming level" to set the stand-by dimming level at 10% / 20% / 30% / 50%.

### Auto-configuration function

All buttons in this zone are disabled.

### Dual tech & RF mode

All buttons in this zone are disabled.

## Settings (Remote Control HRC-05, for SAM7 & HIRO7/FM & HIRO2)



### Permanent ON/OFF function

Press the "ON/OFF" button, the light goes to permanent on or permanent off mode, and the sensor is disabled.

\* Press "Auto Mode", "RESET" or "Scene mode" buttons to quit this mode.  
The mode will change to AUTO Mode after power failure.

### Auto Mode

#### Sensor mode

Press "Auto Mode" button, the sensor starts to function and all settings remain the same as the latest status before the light is switched on/off.



### Reset function

Press "RESET" button, all settings go back to default settings.

Detection range: 100%; Hold-time: 5min; Stand-by period: 10min;  
Stand-by dimming level: 10%; Lux disabled



### Dim +/-

Long press "Dim +" or "Dim -" to adjust the light brightness during hold-time. "+" means dimming up, "-" means dimming down.



### Test mode

This button is for testing purpose only. The sensor goes to test mode (hold-time is 2s) after commissioning, meanwhile the stand-by period and daylight sensor are disabled.

\* This mode can be ended by pressing "reset", or any button of "scene mode" and "hold-time". The sensor settings are changed accordingly.



### Power output

By pressing these two buttons, the output shifts between 80% (at initial 10,000 hours) and 100%, for energy saving purpose.



### Ambient daylight threshold

Press this button, the latest surrounding lux value overwrites the previous lux value learned, and it is set as the daylight threshold. This feature enables the fixture to function well in any real application circumstances.



### Lux disable

Press this button, the built-in daylight sensor stops working, and all motion detected could turn on the lighting fixture, no matter how bright the natural light is.



### Auto mode / Semi-auto mode (absence detection)

By pressing this button, the sensor goes to Auto mode or Semi-auto mode (absence detection) function.

\* For SAM7, the buzzer beeps once if it's Auto mode function, and beeps twice if it shifts to Semi-auto mode (absence detection).  
For HIRO2, the LED indicator flashes if it's Auto mode function, and is on for 2 seconds if it shifts to Semi-auto mode (absence detection).

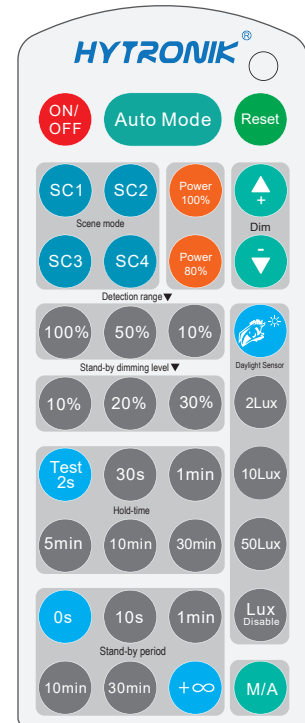

HRC-05

*Note: the buzzer beeps one time when RC receives signal successfully.*

## Scene mode

There are 4 scene modes fixed program built in the remote control to choose for different applications:

| Scene options | Detection range | Hold-time | Stand-by period | Stand-by dimming level | Daylight sensor |
|---------------|-----------------|-----------|-----------------|------------------------|-----------------|
| SC1           | 100%            | 1 min     | 10min           | 10%                    | 2Lux            |
| SC2           | 100%            | 5min      | 10min           | 10%                    | 2Lux            |
| SC3           | 100%            | 10min     | 30min           | 10%                    | 10Lux           |
| SC4           | 100%            | 10min     | +∞              | 10%                    | 50Lux           |

\* End-user can adjust the settings by pressing buttons of detection range/hold-time/stand-by period/stand-by dimming level/daylight sensor. The last setting stays in validity.

### Detection range

Press the buttons of "detection range" to set detection range at 10% / 50% / 100%.

**Note: these buttons are invalid for antenna module HIRO2.**

### Hold-time

Press the buttons of "hold-time" to set hold-time at 30s / 1 min / 5min / 10min / 30min.

### Daylight sensor

Press the buttons of "daylight sensor" to set daylight threshold at 2Lux / 10Lux / 50Lux.

### Stand-by period (corridor function)

Press the buttons of "stand-by period" to set stand-by period at 0s / 10s / 1 min / 10min / 30min / +∞.

\* "0s" means on/off control; "+∞" means bi-level dimming control, the fixture never switches off when daylight sensor is disabled.

### Stand-by dimming level

Press the buttons of "stand-by dimming level" to set the stand-by dimming level at 10% / 20% / 30%.

## Additional Information / Documents

1. For full explanation of Hytronik Photocell Advance™ technology, please kindly refer to [www.hytronik.com/download ->knowledge ->Introduction of Photocell Advance](http://www.hytronik.com/download->knowledge->Introduction%20of%20Photocell%20Advance)
2. Regarding precautions for microwave sensor installation and operation, please kindly refer to [www.hytronik.com/download ->knowledge ->Microwave Sensors - Precautions for Product Installation and Operation](http://www.hytronik.com/download->knowledge->Microwave%20Sensors%20-%20Precautions%20for%20Product%20Installation%20and%20Operation)
3. Regarding precautions for PIR sensor installation and operation, please kindly refer to [www.hytronik.com/download ->knowledge ->PIR Sensors - Precautions for Product Installation and Operation](http://www.hytronik.com/download->knowledge->PIR%20Sensors%20-%20Precautions%20for%20Product%20Installation%20and%20Operation)
4. Data sheet is subject to change without notice. Please always refer to the most recent release on [www.hytronik.com/products/Motion Sensors ->Built-in HF Sensor](http://www.hytronik.com/products/Motion%20Sensors->Built-in%20HF%20Sensor)
5. Regarding Hytronik standard guarantee policy, please refer to [www.hytronik.com/download ->knowledge ->Hytronik Standard Guarantee Policy](http://www.hytronik.com/download->knowledge->Hytronik%20Standard%20Guarantee%20Policy)