

Detached Motion Sensor with  Bluetooth® 5.0 SIG Mesh

HC038V/BT

0/1-10V Output

HCD038/BT

DALI Output

HYTRONIK®



Product Description

HC038V/BT is a Bluetooth 0/1-10V control base whereas HCD038/BT is a Bluetooth DALI control base with 30mA DALI power supply built in. They work with a wide range of microwave and PIR sensor heads. They are ideal for plastic luminaires as compared to metal luminaires because Bluetooth signal can transmit through plastic. They are suitable for any typical indoor applications such as office, classroom, car park, warehouse and other commercial/industrial areas. With Bluetooth wireless mesh networking, it makes communication much easier without any hardwiring, which eventually adds values to luminaires and saves costs for projects. Meanwhile, simple device setup and commissioning can be done via **Koolmesh™** app.







HC038V/BT











HCD038/BT

App Features

-  Quick setup mode & advanced setup mode
-  Web app/platform for project deployment & data analysis
-  Koolmesh Pro app on iPad for on-site configuration
-  Floorplan feature to simplify project planning
-  One-key device replacement
-  Device social relations check
-  Staircase function (primary & secondary)
-  Remote control via gateway support HBGW01
-  Heat map
-  Dynamic daylight harvest auto-adaptation
-  Grouping luminaires via mesh network
-  Scenes
-  Dusk/Dawn photocell (Twilight function)
-  Tri-level control
-  Daylight harvest
-  Push switch configuration
-  Detailed motion sensor settings
-  Schedule
-  Astro timer (sunrise and sunset)
-  Power-on status (memory against power loss)
-  Offline commissioning
-  Bulk commissioning (copy and paste settings)
-  Different permission levels via authority management
-  Network sharing via QR code or keycode
-  Interoperability with Hytronik Bluetooth product portfolio

-  Compatible with EnOcean BLE switches
-  Internet-of-Things (IoT) featured
-  Device firmware update over-the-air (OTA)
-  Continuous development in progress...

Hardware Features

-  HC038V/BT: 0/1-10V output :
 - 400VA (capacitive)
 - 800W (resistive)
-  HCD038/BT: 30mA DALI broadcast output
-  Plug'n'Play for flexible installation and cost saving assemble
-  Support to control DT8 LED drivers (HCD038/BT)
-  2 Push inputs for flexible manual control(HCD038/BT)
-  Zero crossing detection circuit to reduce in-rush current and prolong relay lifetime (HC038V/BT)
-  Loop-in and loop-out terminals for efficient installation (HC038V/BT only)
-  5-year warranty

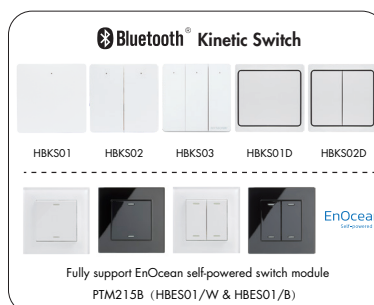

Technical Specifications (HC038V/BT HCD038/BT)

Bluetooth Transceiver	
Operation frequency	2.4 GHz - 2.483 GHz
Transmission power	4 dBm
Range (Typical indoor)	10~30m
Protocol	Bluetooth® 5.0 SIG Mesh
Safety & EMC	
EMC standard (EMC)	EN55015, EN61000, EN61547
Safety standard (LVD)	EN60669-1, EN60669-2-1
RED	EN300328, EN301489-1/-17
Certification	ENEC, CB, CE, RED, RCM

Input & Output Characteristics	
Operating voltage	220~240VAC 50/60Hz
Stand-by power	<1W
Load ratings: HC038V/BT HCD038/BT	Capacitive: 400W; Resistive: 800W max.30mA
Warming-up	20s
Environment	
Operation temperature	Ta: -20°C ~ +55°C
Case temperature (Max.)	Tc: +75°C
IP rating	IP20

Mechanical Structure & Dimensions

HC038V/BT (0/1-10V output)

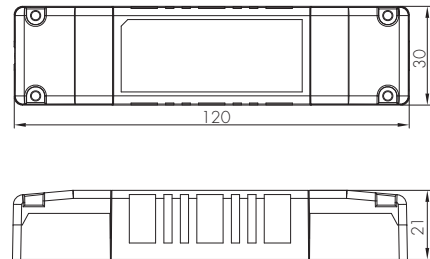
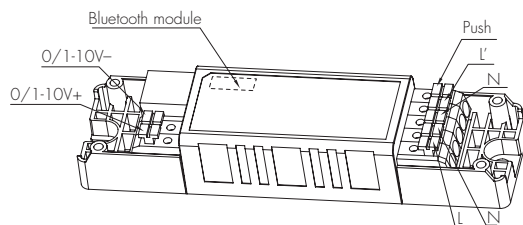

HCD038/BT (DALI output)

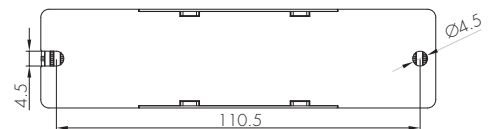
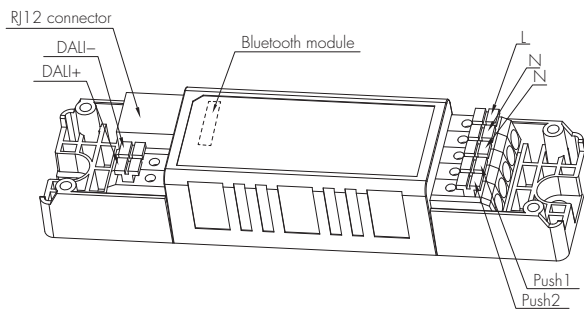

Wire Preparation

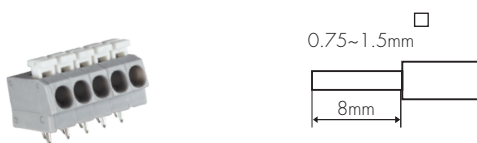

To make or release the wire from the terminal, use a screwdriver to push down the button.

1. 200 metres (total) max. for 1mm² CSA (Ta = 50°C)
2. 300 metres (total) max. for 1.5mm² CSA (Ta = 50°C)

Wiring Diagram

HC038V/BT

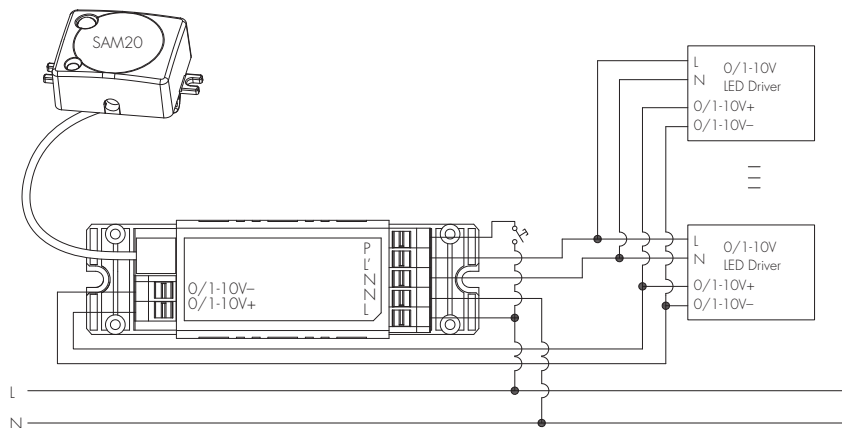

HCD038/BT

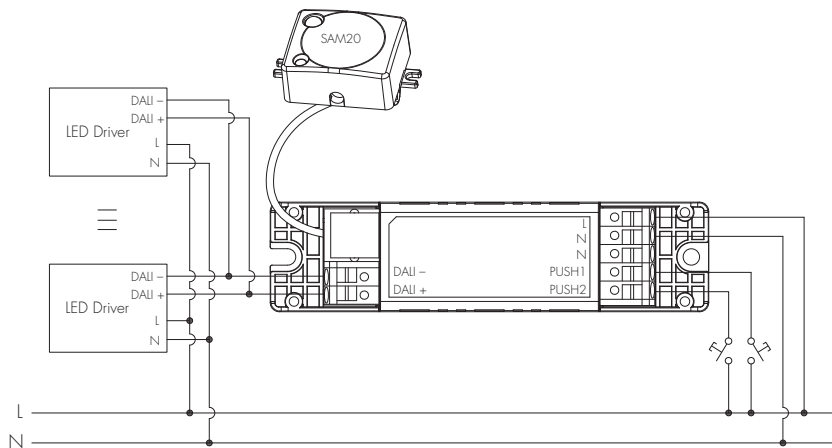

Technical Specifications for Sensor Heads

PIR Sensor Properties		
Sensor principle	PIR detection	
Operating voltage	5VDC	
Detection range *	HIRO5 & HIRO5/FM HIRO5/AA & HIRO7	Max installation height: 3m; Max detection range: 6m (diameter)
	HIR 11	Max installation height: 15m (forklift); 12m (single person); Max detection range: 24m (diameter)
	HIR 12	Max installation height: 15m (forklift); 12m (single person); Max detection range: 18m*6m (L*W)
	HIR63	Max installation height: 3m; Max detection range: 12m (diameter)
	HIR63/R	Max installation height: 12m (forklift); 8m (single person); Max detection range: 14m (diameter)

HF Sensor Properties		
Sensor principle	High Frequency (microwave)	
Operating voltage	5VDC	
Operation frequency	5.8GHz +/- 75MHz	
Transmission power	<0.2mW	
Detection range *	SAM20 & SAM21 SAM22 & SAM22/AA	Max installation height: 3m; Max detection range: 12m (diameter)
	SAM23	Max installation height: 15m (forklift); 12m (single person); Max detection range: 20m (diameter)

* The detection range is heavily influenced by sensor placement (angle) and different walking paces. It may be reduced under certain conditions.

PIR & microwave sensor heads

The range of PIR and microwave sensor heads below offers powerful number of Plug'n'Play feature options to expand the flexibility of luminaire design. This approach to luminaire design reduces space requirements and component costs whilst simplifying production.

A. HIRO5

PIR sensor head
The cable length is around 30cm.

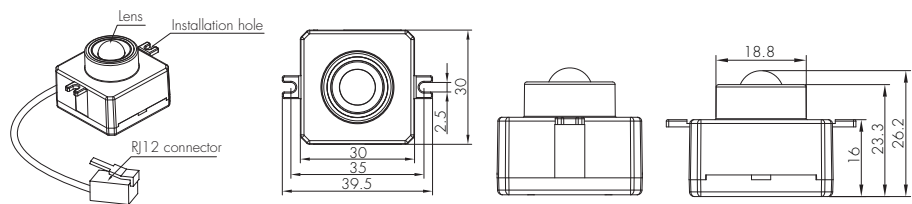

B. HIRO5/FM

PIR sensor head
The cable length is around 30cm.

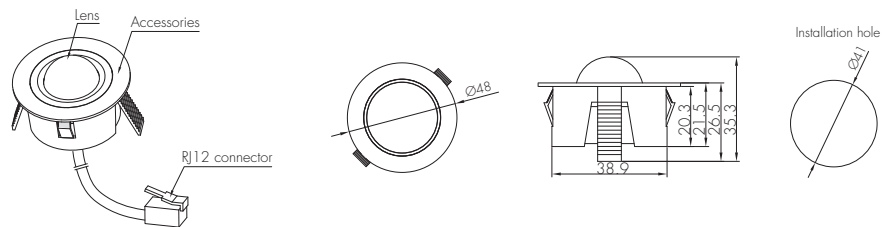

C. HIRO5/AA

PIR sensor head
Adjustable angle
The cable length is around 30cm.

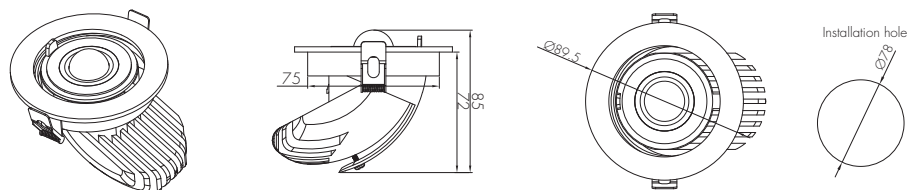

D. HIRO7

PIR sensor head
Photocell Advance™
The cable length is around 30cm.

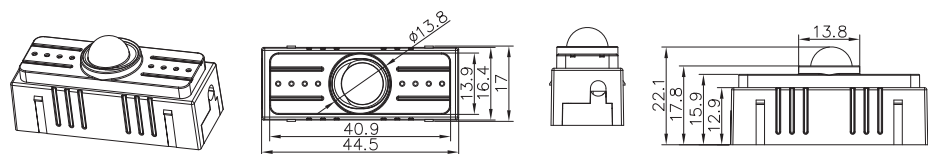

E. HIR11/S

PIR sensor head
Surface mounting
For highbay application
IP65 (facia / lens part)
The cable length is around 30cm.

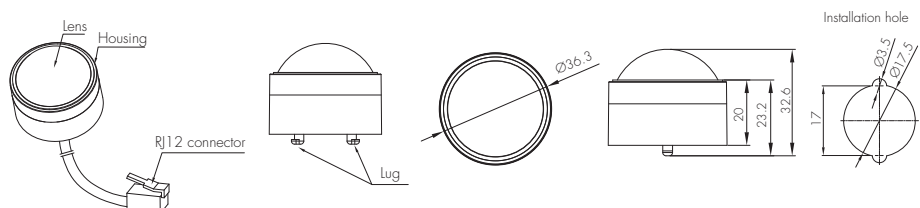

F. HIR11/F

PIR sensor head
 Flush mounting
 For highbay application
 IP65 (facia / lens part)
 The cable length is around 30cm.

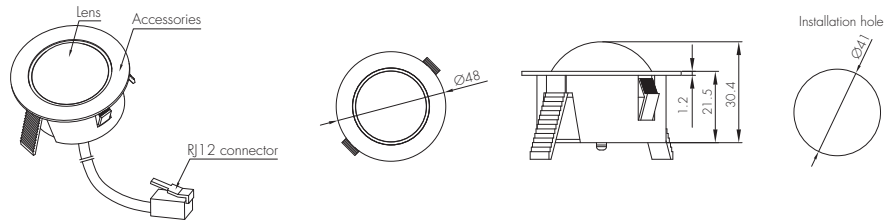
**G. HIR11/C**

PIR sensor head
 Screw to the luminaire by conduit
 For highbay application
 IP65 (facia / lens part)
 The cable length is around 30cm.

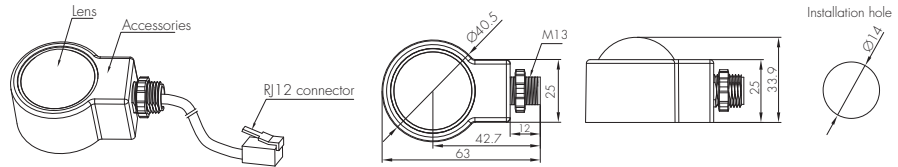
**H. HIR12**

PIR sensor head
 For highbay application
 IP65 (facia / lens part)
 The cable length is around 30cm.

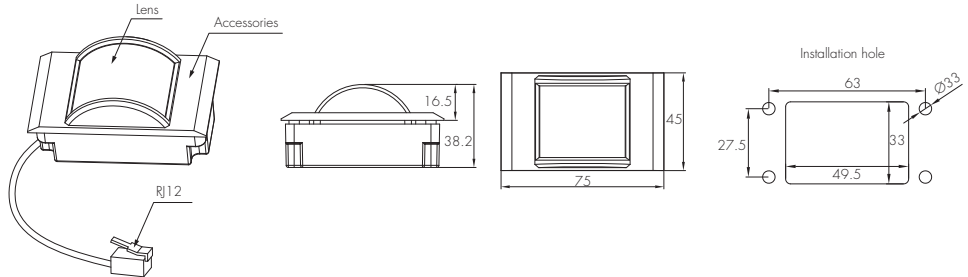
**Installation for HIR12**

We suggest that the metal plate thickness to be 0.8mm – 1.6mm to ensure perfect focal length for the PIR lens.

I. HIR63

PIR sensor head
 The cable length is around 30cm.

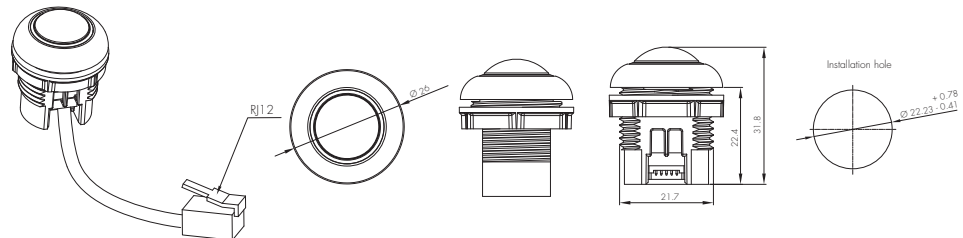
**J. HIR63 with HA04**

PIR sensor head
 Optional accessory
 The cable length is around 30cm.

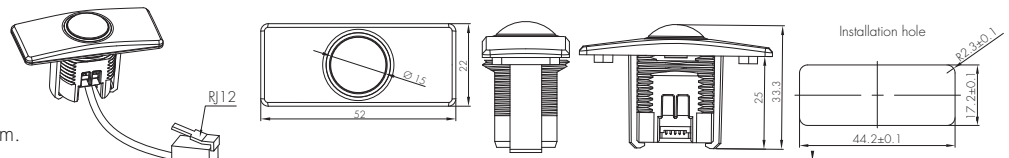
**K. HIR63 with HA05**

PIR sensor head
 Optional accessory
 The cable length is around 30cm.

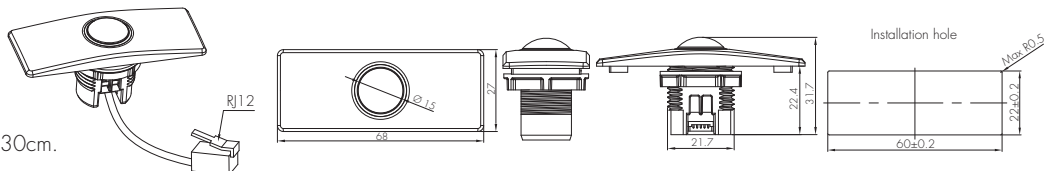
**L. HIR63/R**

PIR sensor head
 IP65 (facia / lens part)
 The cable length is around 30cm.

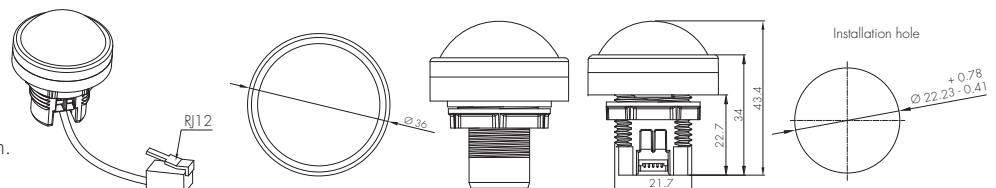

M. SAM20
 HF sensor head
 Photocell Advance™
 The cable length is around 30cm.

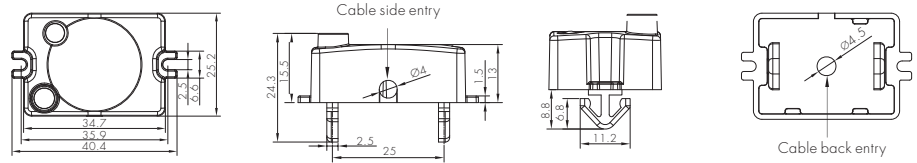

N. SAM21
 HF sensor head
 IP65
 The cable length is around 30cm.

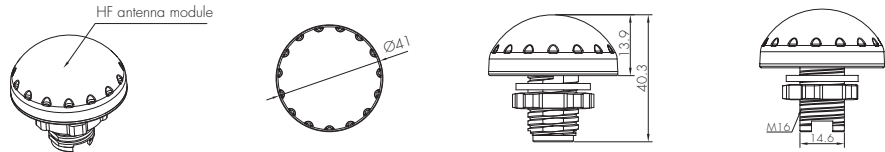

O. SAM22
 HF sensor head
 Flush mount
 The cable length is around 30cm.

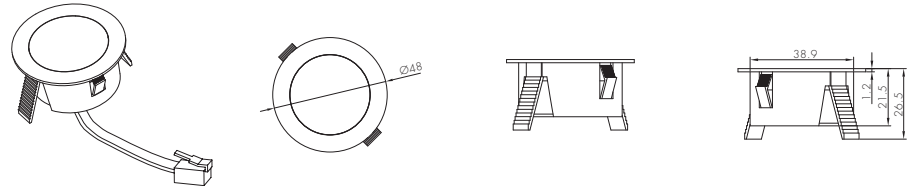

P. SAM22/AA
 HF sensor head
 Adjustable angle
 The cable length is around 30cm.

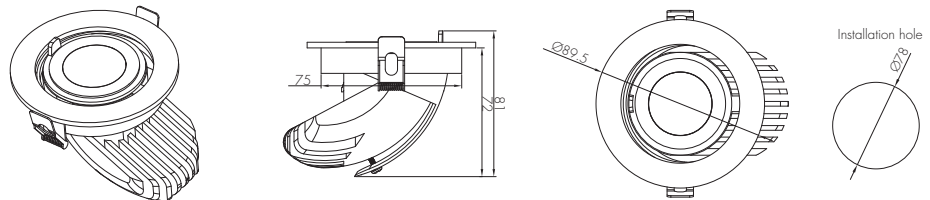

Q. SAM23
 HF sensor head
 Photocell advance™
 Daylight sensor
 For highbay application
 The cable length is around 30cm.

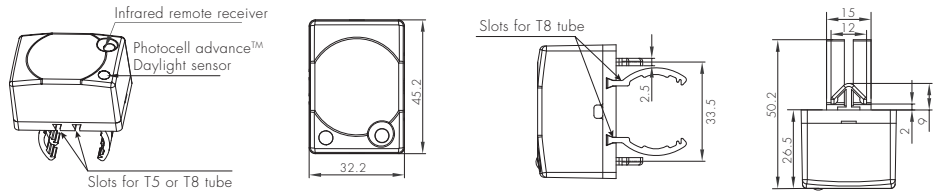

Optional Accessory: Reinforced Bluetooth Antenna

For some special applications, customers may need a larger Bluetooth transmission for both smartphone to device and device to device. Thanks to the reinforced Bluetooth antenna (optional black or white color to choose from), with it being added to the control base HC038V/BT & HCD038/BT, the transmission distance (smartphone to device) enlarges to 20m, the distance of device to device is around 50m.

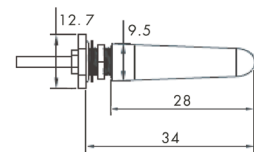
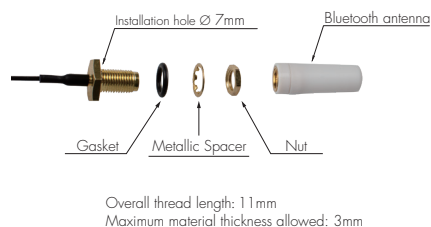
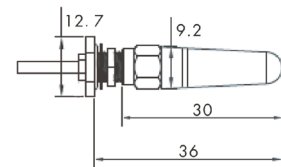
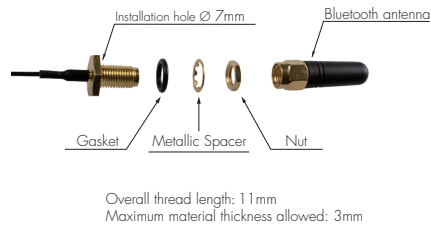

Installation Method



Solder the antenna to the Bluetooth module



Drill a 7mm hole in the fixture
Assemble the antenna parts in turn



Make sure the antenna head is outside the fixture

Detection Pattern

SAM23

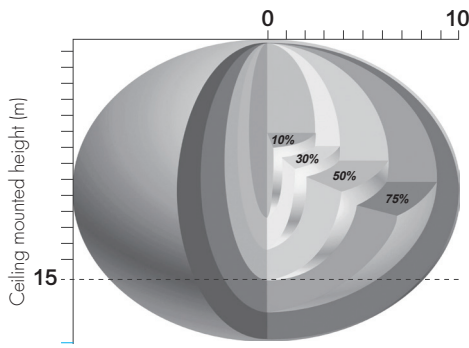

Ceiling mounted detection pattern (m)

SAM20 & SAM21 & SAM22

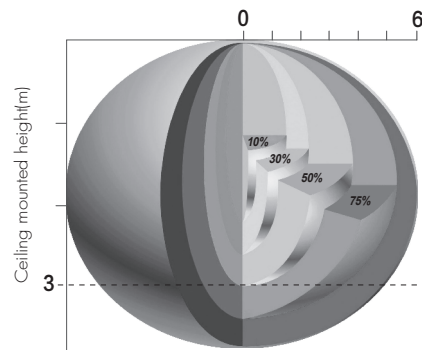

Ceiling mounted detection pattern (m)

Model SAM22/AA

Sensitivity set to maximum, Sensor head angle set to maximum

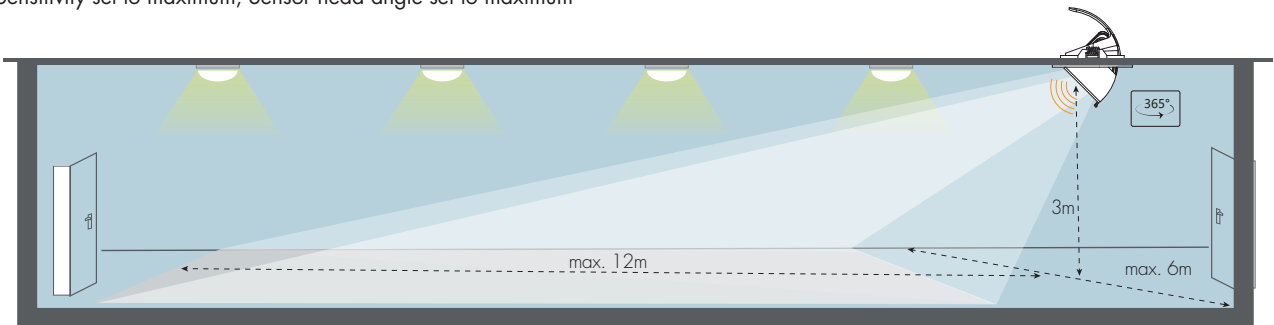

HIRO5 & HIRO5/FM & HIRO5/AA & HIRO7

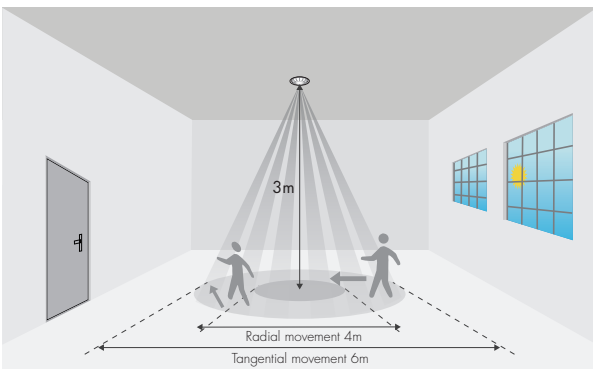

HIR12

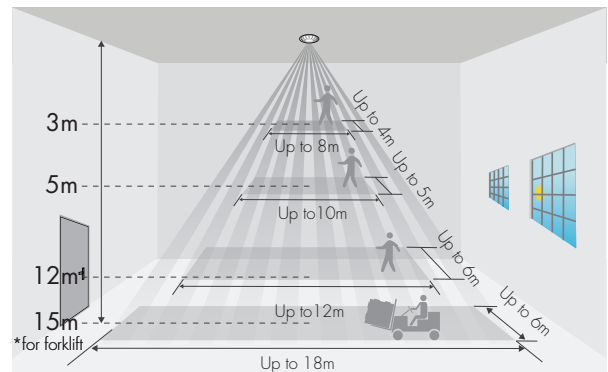

HIR63

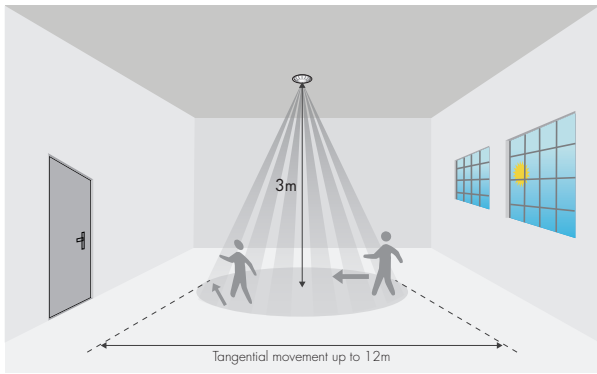

HIR63/R

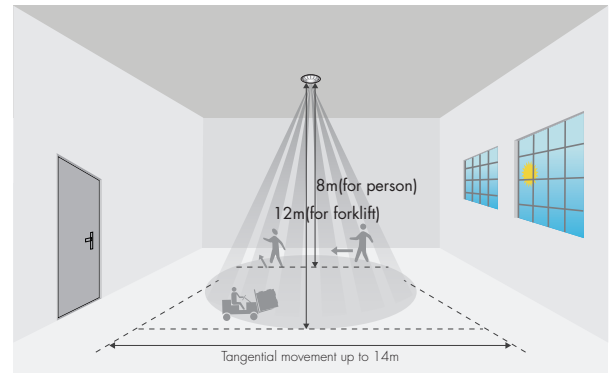

*The detection patterns are based upon 5km/h movement speed.

HIR 11 (High-bay)



HIR 11: High-bay lens detection pattern for forklift @ Ta = 20°C
 (Recommended installation height **10m-15m**)

A: Tangential movement

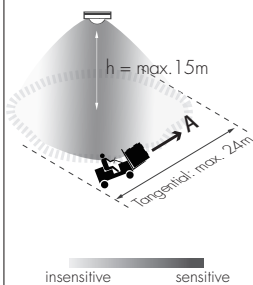

B: Radial movement

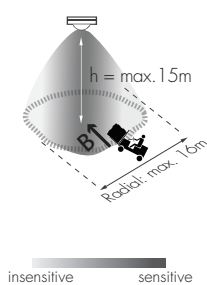

Mount height	Tangential (A)	Radial (B)
10m	max 380m ² (Ø = 22m)	max 201m ² (Ø = 16m)
11m	max 452m ² (Ø = 24m)	max 201m ² (Ø = 16m)
12m	max 452m ² (Ø = 24m)	max 201m ² (Ø = 16m)
13m	max 452m ² (Ø = 24m)	max 177m ² (Ø = 15m)
14m	max 452m ² (Ø = 24m)	max 133m ² (Ø = 13m)
15m	max 452m ² (Ø = 24m)	max 113m ² (Ø = 12m)



HIR 11: High-bay lens detection pattern for single person @ Ta = 20°C
 (Recommended installation height **2.5m-12m**)

A: Tangential movement

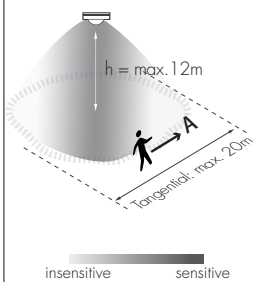

B: Radial movement

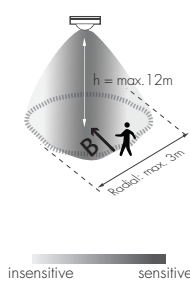

Mount height	Tangential (A)	Radial (B)
2.5m	max 50m ² (Ø = 8m)	max 7m ² (Ø = 3m)
6m	max 104m ² (Ø = 11.5m)	max 7m ² (Ø = 3m)
8m	max 154m ² (Ø = 14m)	max 7m ² (Ø = 3m)
10m	max 227m ² (Ø = 17m)	max 7m ² (Ø = 3m)
11m	max 269m ² (Ø = 18.5m)	max 7m ² (Ø = 3m)
12m	max 314m ² (Ø = 20m)	max 7m ² (Ø = 3m)

Dimming Interface Operation Notes

Switch-Dim

The provided Switch-Dim interface allows for a simple dimming method using commercially available non-latching (momentary) wall switches. Detailed Push switch configurations can be set on Koolmesh app.

Switch Function	Action	Descriptions
Push switch	Short press (<1 second) * Short press has to be longer than 0.1s, or it will be invalid.	- Turn on/off - Turn on only - Turn off only - Recall a scene - Quit manual mode - Do nothing
	Double push	- Turn on only - Turn off only - Recall a scene - Quit manual mode - Do nothing
	Long press (≥1 second)	- Dimming - Colour tuning - Do nothing
Sensor-link	/	- Upgrade a normal on/off motion sensor to a Bluetooth controlled motion sensor
Emergency Self-Test Function	Short press (<1 second) * Short press has to be longer than 0.1s, or it will be invalid.	- Start Self test (Monthly) - Stop Self test - Start Self test (Annually) - Invalid
	Long press (≥1 second)	- Start Self test (Monthly) - Stop Self test - Start Self test (Annually) - Invalid
Fire Alarm (VFC signal only)	Refer to Koolmesh™ App User Manual V2.1	- Able to connect the Fire Alarm system - Once the fire alarm system is triggered, all the luminaries controlled by the Push Switch will enter the preset scene (normally it's full on), after the fire alarm system gives the ending signal, all the luminaries controlled by this Push Switch will revert back to normal status.

Additional Information / Documents

- For full explanation of Hytronik Photocell Advance™ technology, please kindly refer to [www.hytronik.com/download ->knowledge ->Introduction of Photocell Advance](http://www.hytronik.com/download->knowledge->Introduction%20of%20Photocell%20Advance)
- To learn more about detailed product features/functions, please refer to [www.hytronik.com/download ->knowledge ->Introduction of App Scenes and Product Functions](http://www.hytronik.com/download->knowledge->Introduction%20of%20App%20Scenes%20and%20Product%20Functions)
- Regarding precautions for Bluetooth product installation and operation, please kindly refer to [www.hytronik.com/download ->knowledge ->Bluetooth Products - Precautions for Product Installation and Operation](http://www.hytronik.com/download->knowledge->Bluetooth%20Products%20-%20Precautions%20for%20Product%20Installation%20and%20Operation)
- Regarding precautions for microwave sensor installation and operation, please kindly refer to [www.hytronik.com/download ->knowledge ->Microwave Sensors - Precautions for Product Installation and Operation](http://www.hytronik.com/download->knowledge->Microwave%20Sensors%20-%20Precautions%20for%20Product%20Installation%20and%20Operation)
- Regarding precautions for PIR Sensors installation and operation, please kindly refer to [www.hytronik.com/download ->knowledge ->PIR Sensors - Precautions for Product Installation and Operation](http://www.hytronik.com/download->knowledge->PIR%20Sensors%20-%20Precautions%20for%20Product%20Installation%20and%20Operation)
- Data sheet is subject to change without notice. Please always refer to the most recent release on [www.hytronik.com/products/bluetooth technology ->Bluetooth Sensors](http://www.hytronik.com/products/bluetooth%20technology->Bluetooth%20Sensors)
- Regarding Hytronik standard guarantee policy, please refer to [www.hytronik.com/download ->knowledge ->Hytronik Standard Guarantee Policy](http://www.hytronik.com/download->knowledge->Hytronik%20Standard%20Guarantee%20Policy)