

Super Mini On/Off Control HF Motion Sensor

HC007S

Against wireless signals interference

HYTRONIK®

CE emc RED S Internet CB IP20

Applications

Occupancy detector with on/off control suitable for indoor use.

Suitable for building into the fixture:

- Office / Commercial Lighting
- Meeting rooms
- Classroom

Ideal for new luminaire designs and project installations



Features

- Super mini compact size
- Robust design to prevent wireless signal interference such as Wi-Fi, GSM tower, ultra-high-voltage cable etc.
- Zero crossing detection circuit reduces in-rush current and prolongs relay life
- Loop-in and loop-out terminal for efficient installation
- 5-Year Warranty

Technical Data

Input & Output Characteristics	
Mains voltage	220~240VAC 50/60Hz
Stand-by power	<0.3W
Load ratings:	
Capacitive	300VA
Resistive	400W
Warming-up	10s

Safety and EMC	
EMC standard (EMC)	EN55015, EN61000
Safety standard (LVD)	EN61347-1, EN61347-2-11
Radio Equipment (RED)	EN300440, EN301489-1/-3, EN62479
Certification	Semko, CB, CE, EMC, RED, RCM

Sensor Data	
Sensor principle	High Frequency (microwave)
Operation frequency	5.8GHz +/- 75MHz
Transmission power	<0.2mW
Detection range (Max.)*	Installation Height : 6m Detection Range(Ø) : 10m@3m height
Detection angle	30°~ 150°
Setting adjustments:	
Sensitivity	10% / 50% / 75% / 100%
Hold-time	5s / 90s / 5min / 15min
Daylight threshold	2lux / 10lux / 50lux / disable

Environment	
Operation temperature	Ta: -20°C ~ +60°C
Case temperature (Max.)	Tc: +75°C
IP rating	IP20

* The detection range is heavily influenced by sensor placement (angle) and different walking paces. It may be reduced under certain conditions.

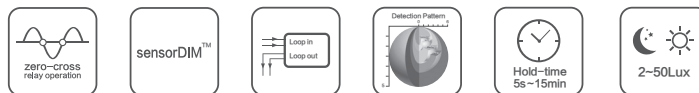
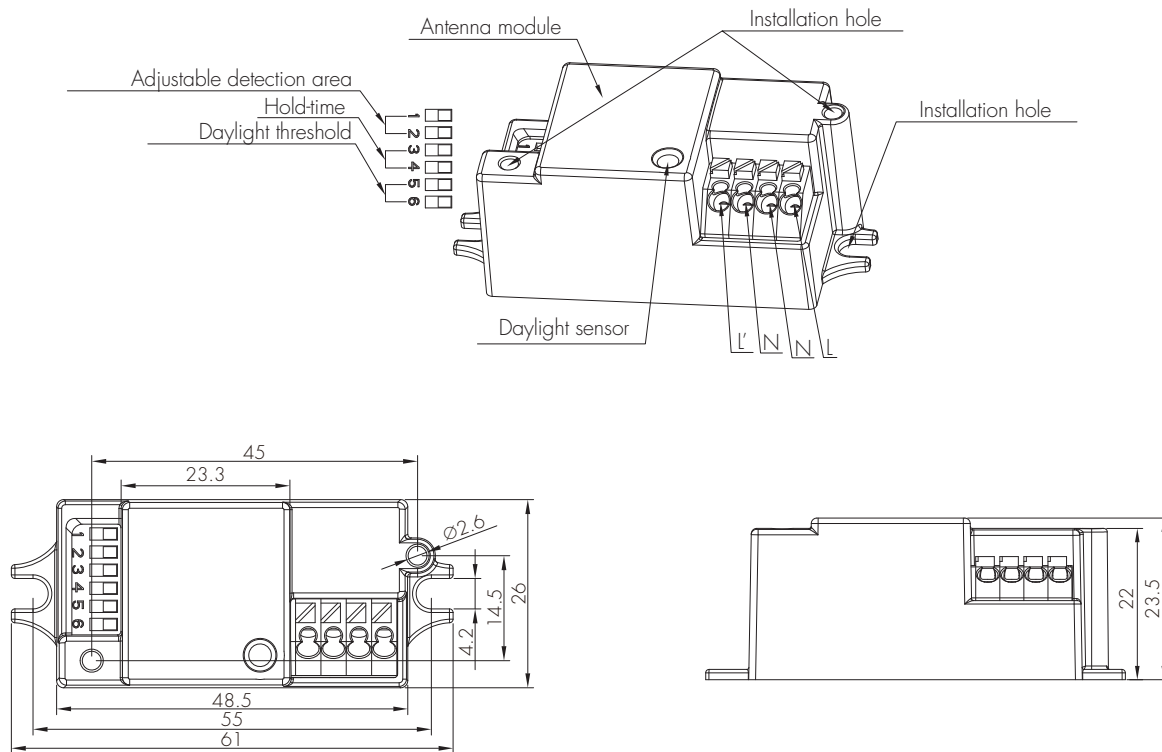

Functions and Features

1 On/off Control

This sensor is a motion switch, which turns on the light upon detection of motion, and turns off after a pre-selected hold-time when there is no movement. A daylight sensor is also built in to prevent the light from switching on when there is sufficient natural light.

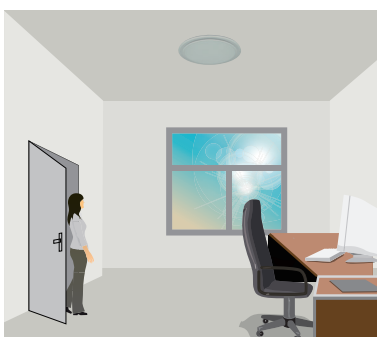

With sufficient natural light, the light does not switch on when presence is detected.

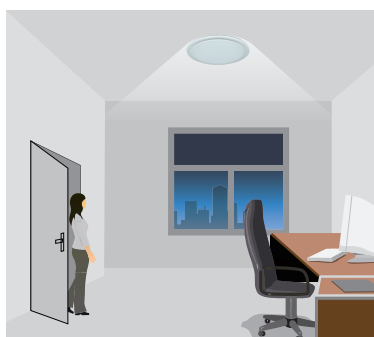

With insufficient natural light, the sensor switches on the light automatically when presence is detected.

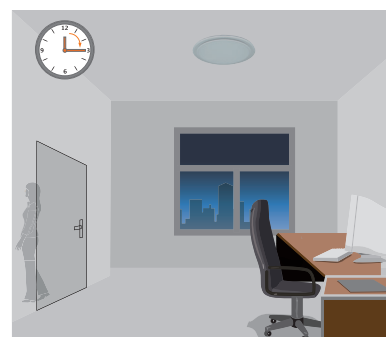

The sensor switches off the light automatically after the hold-time when there is no motion detected.

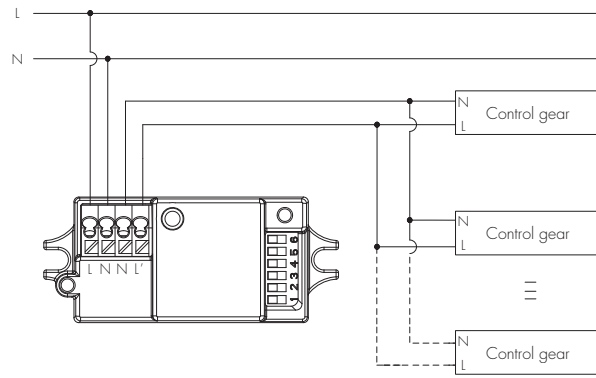

2 Zero-cross Relay Operation

Designed in the software, sensor switches on/off the load right at the zero-cross point, to ensure that the in-rush current is minimised, enabling the maximum lifetime of the relay.

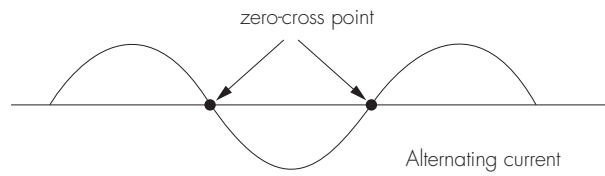

3 Loop-in and Loop-out Terminal

Double L N terminal makes it easy for wire loop-in and loop-out, and saves the cost of terminal block and assembly time.

4 SensorDIM™ Function

Working with Switch-dim. control gear (Excel ballast/driver, corridor function), this sensor can also achieve tri-level control.

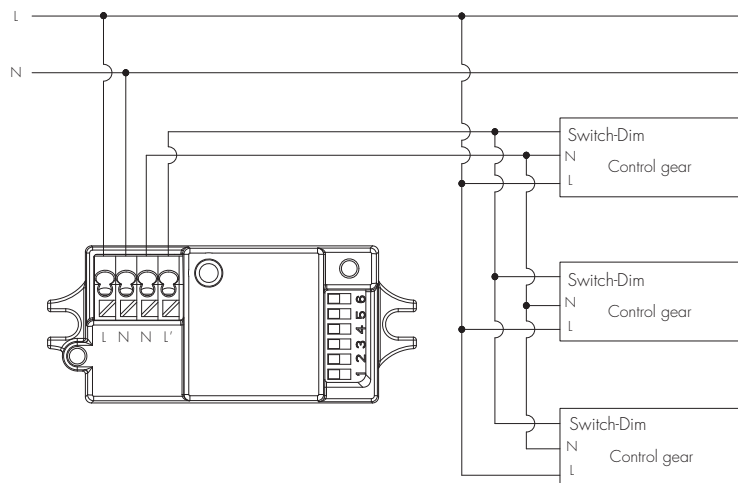

Detection Pattern

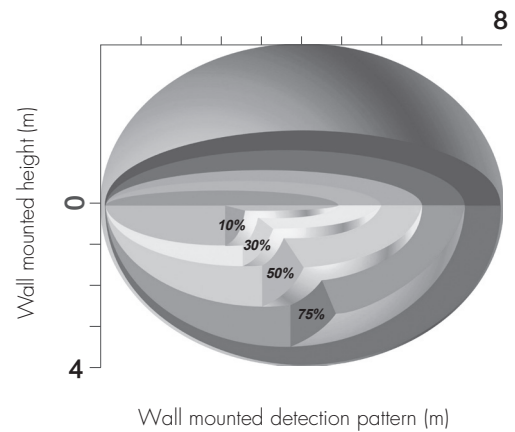
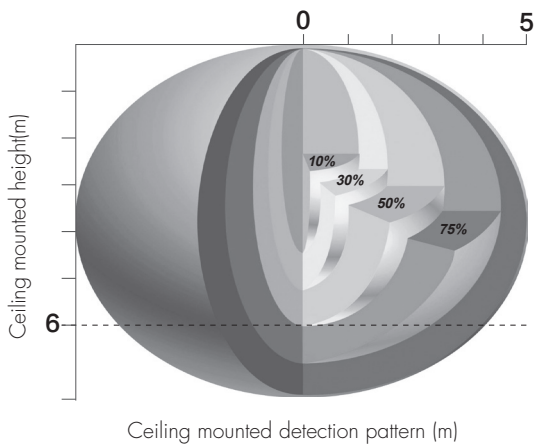

DIP Switch Settings

1 Detection Range

Sensor sensitivity can be adjusted by selecting the combination on the DIP switches to fit precisely for each specific application.

	1	2	
I	●	●	100%
II	●	○	75%
III	○	●	50%
IV	○	○	10%



I – 100%
 II – 75%
 III – 50%
 IV – 10%

2 Hold Time

Select the DIP switch configuration for the light on-time after presence detection. This function is disabled when natural light is sufficient.

	3	4	
I	●	●	5s
II	●	○	90s
III	○	●	5min
IV	○	○	15min



I – 5s
 II – 90s
 III – 5min
 IV – 15min

3 Daylight Threshold

Set the level according to the fixture and environment. The light will not turn on if ambient lux level exceeds the daylight threshold preset.

Please note that the ambient lux level refers to internal light reaching the sensor.

Disabling the daylight sensor will put the sensor into occupancy detection only mode.

	5	6	
I	●	●	Disable
II	●	○	50Lux
III	○	●	10Lux
IV	○	○	2Lux



I – Disable
 II – 50 Lux
 III – 10 Lux
 IV – 2 Lux

Additional Information / Documents

1. Regarding precautions for microwave sensor installation and operation, please kindly refer to www.hytronik.com/download->knowledge ->Microwave Sensors - Precautions for Product Installation and Operation
2. Data sheet is subject to change without notice. Please always refer to the most recent release on www.hytronik.com/products/Motion Sensors ->Built-in HF Sensor
3. Regarding Hytronik standard guarantee policy, please refer to www.hytronik.com/download->knowledge ->Hytronik Standard Guarantee Policy